

SERVICE MANUAL



Color Inkjet Printer

EPSON Stylus Photo R340/350

Notice

- ❑ All rights reserved. No part of this manual may be reproduced, stored in a retrieval system, or transmitted in any form or by any means electronic, mechanical, photocopying, or otherwise, without the prior written permission of SEIKO EPSON CORPORATION.
- ❑ The contents of this manual are subject to change without notice.
- ❑ All effort have been made to ensure the accuracy of the contents of this manual. However, should any errors be detected, SEIKO EPSON would greatly appreciate being informed of them.
- ❑ The above notwithstanding SEIKO EPSON CORPORATION can assume no responsibility for any errors in this manual or the consequences thereof.

EPSON is a registered trademark of SEIKO EPSON CORPORATION.

*General Notice: Other product names used herein are for identification purpose only and may be trademarks or registered trademarks of their respective owners.
EPSON disclaims any and all rights in those marks.*

Copyright © 2005 SEIKO EPSON CORPORATION.
I&I CS/Quality Management & PL Department

PRECAUTIONS

Precautionary notations throughout the text are categorized relative to 1) Personal injury and 2) damage to equipment.

DANGER Signals a precaution which, if ignored, could result in serious or fatal personal injury. Great caution should be exercised in performing procedures preceded by DANGER Headings.

WARNING Signals a precaution which, if ignored, could result in damage to equipment.

The precautionary measures itemized below should always be observed when performing repair/maintenance procedures.

DANGER

1. ALWAYS DISCONNECT THE PRODUCT FROM THE POWER SOURCE AND PERIPHERAL DEVICES PERFORMING ANY MAINTENANCE OR REPAIR PROCEDURES.
2. NO WORK SHOULD BE PERFORMED ON THE UNIT BY PERSONS UNFAMILIAR WITH BASIC SAFETY MEASURES AS DICTATED FOR ALL ELECTRONICS TECHNICIANS IN THEIR LINE OF WORK.
3. WHEN PERFORMING TESTING AS DICTATED WITHIN THIS MANUAL, DO NOT CONNECT THE UNIT TO A POWER SOURCE UNTIL INSTRUCTED TO DO SO. WHEN THE POWER SUPPLY CABLE MUST BE CONNECTED, USE EXTREME CAUTION IN WORKING ON POWER SUPPLY AND OTHER ELECTRONIC COMPONENTS.
4. WHEN DISASSEMBLING OR ASSEMBLING A PRODUCT, MAKE SURE TO WEAR GLOVES TO AVOID INJURIER FROM METAL PARTS WITH SHARP EDGES.

WARNING

1. REPAIRS ON EPSON PRODUCT SHOULD BE PERFORMED ONLY BY AN EPSON CERTIFIED REPAIR TECHNICIAN.
2. MAKE CERTAIN THAT THE SOURCE VOLTAGES IS THE SAME AS THE RATED VOLTAGE, LISTED ON THE SERIAL NUMBER/RATING PLATE. IF THE EPSON PRODUCT HAS A PRIMARY AC RATING DIFFERENT FROM AVAILABLE POWER SOURCE, DO NOT CONNECT IT TO THE POWER SOURCE.
3. ALWAYS VERIFY THAT THE EPSON PRODUCT HAS BEEN DISCONNECTED FROM THE POWER SOURCE BEFORE REMOVING OR REPLACING PRINTED CIRCUIT BOARDS AND/OR INDIVIDUAL CHIPS.
4. IN ORDER TO PROTECT SENSITIVE MICROPROCESSORS AND CIRCUITRY, USE STATIC DISCHARGE EQUIPMENT, SUCH AS ANTI-STATIC WRIST STRAPS, WHEN ACCESSING INTERNAL COMPONENTS.
5. DO NOT REPLACE IMPERFECTLY FUNCTIONING COMPONENTS WITH COMPONENTS WHICH ARE NOT MANUFACTURED BY EPSON. IF SECOND SOURCE IC OR OTHER COMPONENTS WHICH HAVE NOT BEEN APPROVED ARE USED, THEY COULD CAUSE DAMAGE TO THE EPSON PRODUCT, OR COULD VOID THE WARRANTY OFFERED BY EPSON.
6. WHEN USING COMPRESSED AIR PRODUCTS; SUCH AS AIR DUSTER, FOR CLEANING DURING REPAIR AND MAINTENANCE, THE USE OF SUCH PRODUCTS CONTAINING FLAMMABLE GAS IS PROHIBITED.

About This Manual

This manual describes basic functions, theory of electrical and mechanical operations, maintenance and repair procedures of the printer. The instructions and procedures included herein are intended for the experienced repair technicians, and attention should be given to the precautions on the preceding page.

Manual Configuration

This manual consists of six chapters and Appendix.

CHAPTER 1. TROUBLESHOOTING

Describes the step-by-step procedures for the troubleshooting.

CHAPTER 2. DISASSEMBLY / ASSEMBLY

Describes the step-by-step procedures for disassembling and assembling the product.

CHAPTER 3. ADJUSTMENT

Provides Epson-approved methods for adjustment.

CHAPTER 4. MAINTENANCE

Provides preventive maintenance procedures and the lists of Epson-approved lubricants and adhesives required for servicing the product.

APPENDIX Provides the following additional information for reference:

- Block Diagram
- Electrical circuit boards schematics

Symbols Used in this Manual

Various symbols are used throughout this manual either to provide additional information on a specific topic or to warn of possible danger present during a procedure or an action. Be aware of all symbols when they are used, and always read NOTE, CAUTION, or WARNING messages.



Indicates an operating or maintenance procedure, practice or condition that is necessary to keep the product's quality.



Indicates an operating or maintenance procedure, practice, or condition that, if not strictly observed, could result in damage to, or destruction of, equipment.



May indicate an operating or maintenance procedure, practice or condition that is necessary to accomplish a task efficiently. It may also provide additional information that is related to a specific subject, or comment on the results achieved through a previous action.



Indicates an operating or maintenance procedure, practice or condition that, if not strictly observed, could result in injury or loss of life.



Indicates that a particular task must be carried out according to a certain standard after disassembly and before re-assembly, otherwise the quality of the components in question may be adversely affected.

Revision Status

Revision	Issued Date	Description
A	September 16, 2005	First Release

CONTENTS

Chapter 1 Troubleshooting

1.1 Overview	8
1.2 Warning/Error Messages and Possible Causes	9
1.3 Troubleshooting	13
1.3.1 Troubleshooting by Error Message	13
1.3.2 Troubleshooting by Observed Symptom	30

Chapter 2 Disassembly and Assembly

2.1 Overview	37
2.1.1 Precautions	37
2.1.2 Tools	38
2.1.3 Work Completion Checklist	38
2.2 Ensuring the Quality of Disassembled/Reassembled Printer Mechanism	39
2.3 Disassembly	41
2.3.1 Removing the Paper Support Assy.	42
2.3.2 Removing the Left Housing	43
2.3.3 Removing the Right Housing	44
2.3.4 Removing the Panel Board/LCD Module	46
2.3.5 Removing the Upper Housing	48
2.3.6 Removing the Rear Housing	50
2.3.7 Removing the Stacker Assy.	51
2.3.8 Removing the Front Paper Guide Porous Pads	52
2.3.9 Removing the Main Board Assy.	54
2.3.10 Removing the ASF Assy.	58
2.3.11 Removing the Shaft Assy. Holder	62
2.3.12 Removing the CR Motor	66
2.3.13 Removing the Print Head	67
2.3.14 Removing the Upper Paper Guide	69
2.3.15 Removing the Printer Mechanism	70
2.3.16 Removing the Power Supply Assy.	74
2.3.17 Removing the Waste Ink Pads	75
2.3.18 Removing the Lower Housing	76
2.3.19 Removing the APG Assy.	77
2.3.20 Removing the Carriage Unit	78

2.3.21 Removing the CD-R Guide Assy.	84
2.3.22 Removing the Ink System	88
2.3.23 Removing the Front Paper Guide and EJ Roller Assy.	91
2.3.24 Removing the PF Motor	95
2.3.25 Removing the PF Roller Assy.	96

Chapter 3 Adjustment

3.1 Adjustment Items and Overview	99
3.1.1 Replacement Part-Based Adjustment Priorities	99
3.2 Adjustment by using adjustment program	101
3.2.1 How to judge print samples by using the adjustment program	105
3.2.1.1 Head Angular Adjustment	105
3.2.1.2 Bi-d Adjustment	105
3.2.1.3 PW Sensor Adjustment/First Dot Adjustment/ Top Margin Adjustment	106
3.3 Adjustment Except Adjustment Program	108
3.3.1 PG Adjustment	108

Chapter 4 Maintenance

4.1 Overview	112
4.1.1 Cleaning	112
4.1.2 Service Maintenance	112
4.1.3 Lubrication	113

Chapter 5 Appendix

5.1 Block Diagram	122
5.2 Exploded Diagram	124
5.3 Electrical Circuits	124

CHAPTER

1

TROUBLESHOOTING

1.1 Overview

This chapter describes how to troubleshoot problems. Be sure to see the tables provided in this chapter to identify the component that caused the problem you face. And follow the instructions in the table to troubleshoot the component. Also refer to the Motor Wire-Wound Resistor and Sensor Check Points.

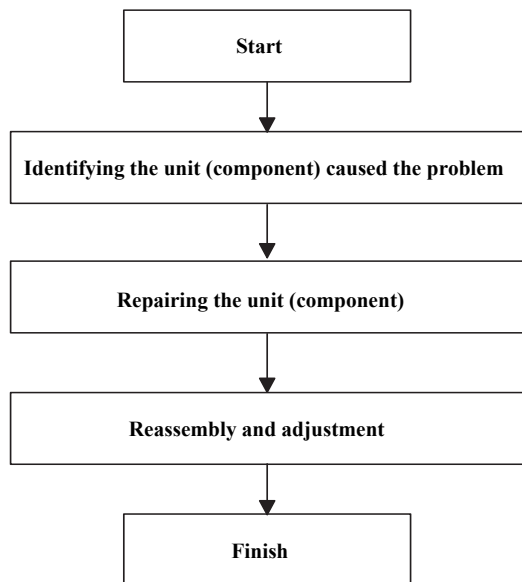

Figure 1-1. Troubleshooting Workflow

Table 1-1. Motor Wire-Wound Resistor

Motor	Connected Pin No.	Check Point	Resistance
PF Motor (ASF/Pump Motor)	CN10	Pin 1 and 3 Pin 2 and 4	3.0Ω ±10% (25°C/phase)

NOTE: As the CR Motor and the APG Motor are DC motors, the resistance between the pins fluctuates. So checking them if they work properly or not is made only by observing them visually (if they rotate or not). It is, however, sometimes difficult to judge, so when in doubt, replace the motor.

Table 1-2. Sensors Check Point

Sensor	Pin No.	Check point	Signal level	Sensor Statuses
Tray Sensor	CN2	Pin 1 and 2	---	Open: Nipped with Star Wheel (ASF mode)
			---	Close: Star Wheel is released (CDR mode)
CDR Sensor	CN2	Pin 3 and 4	---	Close: CDR Tray not attached
			---	Open: CDR Tray attached
PG Sensor	CN3	Pin 1 and 2	2.4V or more	Close: PG is set to a preset amount
			0.4V or lower	Open: Switching PG setting
PE Sensor	CN4	Pin 1 and 2	2.4V or more	Close: No paper loaded
			0.4V or lower	Open: Paper is loaded

1.2 Warning/Error Messages and Possible Causes

The following tables explain the warning/error messages displayed on the LCD and the possible causes of them. The messages are displayed during the printer is performing various sequences (feeding paper, absorbing ink or etc.) or displayed responding to the operations the user made (turning the power on, loading paper or etc.).

Table 1-3. LCD Error Messages and Possible Causes

LCD Messages	Printer Condition	Possible Causes	Recovery from Errors	Reference
---	Communication error	A communication error between the host computer and the printer occurred.	Correctly connect the printer and the computer.	p.13
(Background of the ink-low status ink cartridge icon is displayed in gray)	The remaining amount of ink is low.	This occurs when consumed amount of ink reached 90%. [Caution] The printer can continue printing operation even after the warning message is displayed on the STM3 screen. However, the printer cannot run a head cleaning.	Replace the ink cartridge(s) with new one(s).	---
No ink cartridge. Set ink cartridge. [BK](T0481) [M](T0483) [C](T0482) [LM](T0486) [LC](T0485) [Y](T0484)	Ink related message 1* (No ink cartridge)	Ink cartridges are not installed or not installed properly.	Recovers from the error after replacement of ink cartridge(s) has completed. [Supplement] <ul style="list-style-type: none"> The message appears within 60 seconds at maximum after the occurrence if no operation has been made during the period. The message appears immediately before starting a print job or cleaning. 	p.15
Ink out. Replace the following ink cartridge. [BK](T0481) [M](T0483) [C](T0482) [LM](T0486) [LC](T0485) [Y](T0484)	Ink related message 5* (Ink Out)	Occurs in the following conditions: <ul style="list-style-type: none"> The consumed ink amount reached 100%. Ink cartridge failure [Caution] The ink cartridge detected as “Ink out” is not totally empty. It still has some amount of ink. This prevents Print Head from damaging by printing without ink.	Replace the ink cartridge(s) with new one(s).	---
Replace the ink cartridge. For best results, use genuine EPSON ink. [BK](T0481) [M](T0483) [C](T0482) [LM](T0486) [LC](T0485) [Y](T0484)	Ink related message 7* (Ink cartridge failure)	Reading and writing of the CSIC information of the ink cartridges could not be performed properly.	Replace the ink cartridge(s) with new one(s).	p.15

NOTE "*" :The ink cartridge codes displayed on the LCD vary according to the model.

Stylus Photo R340 : [BK]T0481,[M]T0483,[C]T0482,[LM]T0486,[LC]T0485,[Y]T0484

Stylus Photo R350 : [BK]T0491,[M]T0493,[C]T0492,[LM]T0496,[LC]T0495,[Y]T0494

Table 1-3. LCD Error Messages and Possible Causes (continued)

LCD Messages	Printer Condition	Possible Causes	Recovery from Errors	Reference
External device is not connected or media is not inserted. Backup canceled.	Backup error (no external connection)	Occurs in the following conditions: <ul style="list-style-type: none"> An external device is not connected to the printer. No media is set into the connected external device. No image is stored on the memory card. 	Automatically recovers from the error after a lapse of three seconds.	---
Insufficient space on the backup device. Backup cannot be performed.	Backup error (insufficient capacity)	The capacity of the media specified to back up is insufficient.	Automatically recovers from the error after a lapse of three seconds.	---
No memory card in slot. Backup canceled.	Backup error (no card)	No memory card is inserted into the slot of the printer.	Automatically recovers from the error after a lapse of three seconds.	---
A printer error occurred. Please see your manual.	Fatal error	Occurs in the following conditions: <ul style="list-style-type: none"> The Carriage Unit cannot move properly because of an external force exerted on the unit. The PF Motor cannot operate properly. 	Turn off the Power.	p.16
Paper out. Load paper press the Start button.	No paper error	The PE Sensor could not detect the top edge of paper during the paper feeding sequence.	Press the Start button. The printer recovers from the error when paper is fed correctly.	p.19
Paper or CD/DVD tray jam or feed error. Press the Start button. If the error does not clear, reinsert the paper or CD/DVD tray and press the Start button.	Jam error	Occurs in the following conditions: <ul style="list-style-type: none"> The PE Sensor could not detect the bottom edge of paper during the paper feeding operation. The Tray/CDR Sensor could not detect the bottom edge of CD or DVD during the CD/DVD feeding operation. 	Remove the jammed paper or the CD/DVD tray.	p.21
Service required. Parts inside your printer are at end of their service life. See your manual for details.	Maintenance error	This error is detected when the amount of the waste liquid absorbed by the Waste Ink Pads has reached its upper limit (when the protection counter has reached its upper limit).	Replace the Waste Ink Pads and reset the Protector Counter.	---
Bluetooth print adapter cannot be recognized. Please remove and reinstall the adapter.	BT communications error	Had no response from the Bluetooth unit when the printer started the Bluetooth communication.	Remove the Bluetooth unit and press the OK button.	---
There is a problem with the IrDA interface. See your manual.	IrDA communications error	Had no response from the IrDA unit when the printer started the infrared data communication.	Remove the IrDA unit.	---
The CD/DVD tray is not set correctly. Reload the tray and press Start to continue.	CDR error (correct set)	Occurs when the printer starts to print on a CD or DVD without the CD/DVD tray attached.	Automatically recovers from the error after a lapse of three seconds.	---
	CDR error (reset request)	The CD/DVD tray could not be detected properly when the printer starts to print on a CD or DVD.	Automatically recovers from the error after a lapse of three seconds.	---

Table 1-3. LCD Error Messages and Possible Causes (continued)

LCD Messages	Printer Condition	Possible Causes	Recovery from Errors	Reference
The CD/DVD guide is open. Close the guide to print on paper.	CDR/DVD guide open	Displayed in the following conditions: <ul style="list-style-type: none"> The CDR Guide Assy. is opened when the printer started to print on a cut sheet. The CDR Guide Assy. is opened during the printer is printing on a cut sheet. 	Automatically recovers from the error after a lapse of three seconds.	p.25
Paper jam. Load paper and press the Start button. If the error does not clear, repeat the procedure.	Name card long edge first insertion error	A name card is loaded onto the printer in landscape orientation.	Remove the jammed card following the instruction displayed on the LCD.	p.27
The CD/DVD tray is not set correctly. Reload the tray and press Start to continue.	Paper mismatch error	The center of the CD or DVD could not be detected during the CD/DVD print job.	Load media that match the print setting.	p.28
Error in the data. The document may not be printed correctly.	A part of the reference object is broken (BT-MIME).	Decoding XHTML print data was made successfully, but failed to obtain all or some reference objects included in the data due to their MIME encode errors. The printout will result in as follows depending on what type of the missed reference objects are: <ul style="list-style-type: none"> Image objects Blank areas on where the missed objects are supposed to be printed appear. CSS (style sheet) files Background color and font size appear differently from what you expected. 	Press any one of the buttons on the printer.	---
	A part of the reference object cannot be buffered (BT-MIME).	Decoding XHTML print data was made successfully, but failed to obtain all or some reference objects included in the data due to insufficient memory or the number of the objects exceeded the upper limit.	Press any one of the buttons on the printer.	---
Error in the data. The document cannot be printed.	XHTML-Print document cannot be decoded (BT-MIME).	Failed to decode XHTML data to print due to MIME encode errors, or XHTML-Print is not contained.	Press any one of the buttons on the printer.	---
Cannot recognize the memory card or disk.	Insertion of unsupported media	Not formatted or not compatible media is inserted.	Automatically recovers from the error after a lapse of three seconds.	---
The document is too large to print with Bluetooth.	BT File size error	The specified XHTML-Print data is larger than 100 K bytes.	Press any one of the buttons on the printer.	---
The document is too complex to print with Bluetooth.	BT designation error	The specified XHTML-Print data is too complicated (tag setting or etc.) to print.	Press any one of the buttons on the printer.	---
Error in the data. The document cannot be printed.	BT structure error	XHTML-Print data could not be decoded.	Press any one of the buttons on the printer.	---

Table 1-3. LCD Error Messages and Possible Causes (continued)

LCD Messages	Printer Condition	Possible Causes	Recovery from Errors	Reference
No memory card or disk inserted, or it cannot be recognized.	Memory card print	A memory card in which has no image data is inserted.	Automatically recovers from the error after a lapse of three seconds.	---
Cannot recognize the memory card or disk.	Card insertion	Cannot recognize the memory card inserted into the printer.	Automatically recovers from the error after a lapse of three seconds.	---
Cannot recognize the device.	External device installment	A not compatible memory device is connected to the port for the external memory devices.	Automatically recovers from the error after a lapse of three seconds.	---
All photos for the specified layout are selected.	Memory card print onto CD/DVD	The number of images retrieved from the memory card to print on a CD exceeded the upper limit.	Automatically recovers from the error after a lapse of three seconds.	---
[BK](T0148) [M](T0483) [C](T0482) [LM](T0486) [LC](T0485) [Y](T0484) The installed ink cartridges differ from the genuine EPSON ink cartridges listed below. The use of other products may affect your print quality and could result in printer damage. Do you want to continue using the currently installed ink cartridges?	Ink related message 3* (wrong model number of ink cartridge)	Non-EPSON ink cartridges are installed.	Press the OK button or the Back button.	---
Even if borderless printing has been selected, a white border may still appear on an edge.	Borderless expansion	Displayed when "Minimum" is selected for the "Borderless expansion" print setting menu.	Automatically recovers from the error after a lapse of three seconds.	---

NOTE "*" :The ink cartridge codes displayed on the LCD vary according to the model.

Stylus Photo R340 : [BK]T0481,[M]T0483,[C]T0482,[LM]T0486,[LC]T0485,[Y]T0484

Stylus Photo R350 : [BK]T0491,[M]T0493,[C]T0492,[LM]T0496,[LC]T0495,[Y]T0494

Table 1-4. Troubleshooting of Communication Errors based on Observed Symptom (continued)

Occurrence Timing CR Position	Symptoms	Failed Part	Check Point	Remedies
<ul style="list-style-type: none"> • Occurrence Timing: At power-on • CR Position: Anywhere 	The printer does not start up at all by turning the power On.	Power Supply Board Assy.	1. Check if the Power Supply Board cable is correctly connected to CN1 on the Main Board. 	1. Correctly connect the Power Supply Board cable to CN1 on the Main Board.
			2. Check if the Power Supply Board cable or the Power Supply itself is damaged. 	2. Replace the Power Supply Assy. with a new one. * If the problem still occurs after performing the above remedies, replace the Main Board Assy. with a new one.
<ul style="list-style-type: none"> • Occurrence Timing: During operation • CR Position: --- 	The initialization sequence at power-on is performed properly. However, a communication error occurs (an error message is displayed on STM3 screen) when a print job is sent to the printer.	USB Cable	1. Check if the printer is correctly connected to the computer with a USB cable.	1. Correctly connect the printer to the computer with a USB cable.
		Printer driver	1. Check if the Stylus Photo R340/350 driver is used for the print job.	1. Install the Stylus Photo R340/350 printer driver on the computer.
		Main Board	1. Verify that the model name written in the EEPROM on the Main Board is correct.	1. Correct the model name stored on the EEPROM using the Market Setting menu in the Adjustment Program.

Table 1-5. Troubleshooting of Ink-related Errors (Message 1 and 7) based on Observed Symptom

Occurrence Timing CR Position	Symptoms	Failed Part	Check Point	Remedies
<ul style="list-style-type: none"> • Occurrence Timing: At power-on • CR Position: Home position 	An ink-related error occurs when the Carriage returns to the home position.	Ink Cartridge	1. Check if the memory chip on the cartridge is chipped or damaged. 	1. Replace the Ink Cartridge with a new one.
		CSIC Connector	1. Check if the CSIC Connector is damaged. 	1. Replace the Carriage Unit with a new one.
		CSIC Board	1. Check if the Head cable is correctly connected to the connector on the CSIC Board. 	1. Correctly connect the Head cable to the connector on the CSIC Board. 2. Check if the CSIC Board is damaged.

Table 1-6. Troubleshooting of Fatal Errors based on Observed Symptom

Occurrence Timing CR Position	Symptoms	Failed Part	Check Point	Remedies
<ul style="list-style-type: none"> • Occurrence Timing: At power-on • CR Position: --- 	The CR Motor does not start to operate at all by turning the power On.	CR Motor	<ol style="list-style-type: none"> 1. Check if the CR Motor cable is correctly connected to CN11 on the Main Board. 	<ol style="list-style-type: none"> 1. Correctly connect the CR Motor cable to CN11 on the Main Board.
	The Carriage Unit hits against the Change Lever which has inclined toward the front of the printer at power-on.	PF Motor	<ol style="list-style-type: none"> 1. Check if the PF Motor cable is correctly connected to CN10 on the Main Board. 	<ol style="list-style-type: none"> 1. Correctly connect the PF Motor cable to CN10 on the Main Board.
		Ink System	<ol style="list-style-type: none"> 1. Check if the Compression Spring 2.36 in the Change Lever has not come off. 	<ol style="list-style-type: none"> 1. Replace the Ink System with a new one.

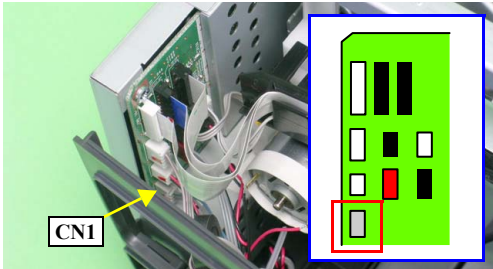
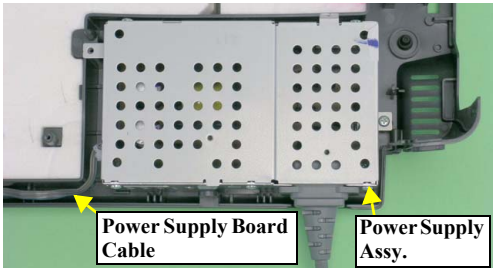
Table 1-6. Troubleshooting of Fatal Errors based on Observed Symptom (continued)

Occurrence Timing CR Position	Symptoms	Failed Part	Check Point	Remedies
<ul style="list-style-type: none"> • Occurrence Timing: At power-on • CR Position: --- 	The Carriage Unit hits against the Upper Paper Guide which has come off the Main Frame at power-on.	Upper Paper Guide	1. Check if the Upper Paper Guide has not come off the Main Frame. 	1. Install the Upper Paper Guide correctly.
	The Carriage Unit hits against the right side of the Main Frame at power-on.	CR Scale	1. Check if the CR Scale gets dirt.	1. Wipe off the dirt completely or replace the CR Scale with a new one if it is stained badly.
			2. Check if the CR Scale is damaged. 3. Check if the CR Scale has come off or it properly runs through the slit of the CR Encoder Sensor. 	2. Replace the CR Scale with a new one. 3. Install the CR Scale correctly. * If the above does not solve the problem, try the following actions one by one in the order given. 1. Replace the Main Board Assy. with a new one. 2. Replace the CR Encoder Sensor with a new one.

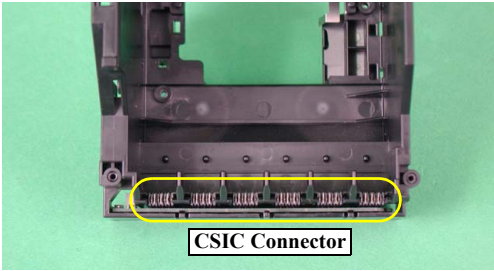
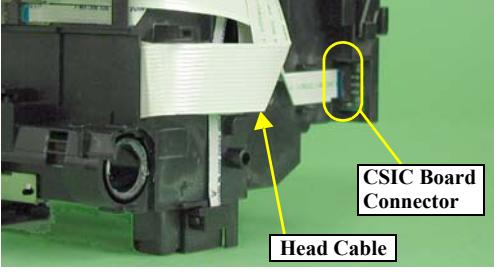
Table 1-6. Troubleshooting of Fatal Errors based on Observed Symptom (continued)

Occurrence Timing CR Position	Symptoms	Failed Part	Check Point	Remedies
<ul style="list-style-type: none"> • Occurrence Timing: At power-on • CR Position: --- 	<p>The Carriage Unit hits against the right side of the Main Frame at power-on.</p>	<p>Head Cable</p>	<ol style="list-style-type: none"> 1. Check if the Head cable is correctly connected to the connector on the CR Encoder Sensor Board and CN9 on the Main Board. <div style="text-align: center;"> </div> <ol style="list-style-type: none"> 2. Check if the Head Cable is damaged. 	<ol style="list-style-type: none"> 1. Correctly connect the Head cable to the connector on the CR Encoder Sensor Board and CN9 on the Main Board. 2. Replace the Head Cable with a new one.

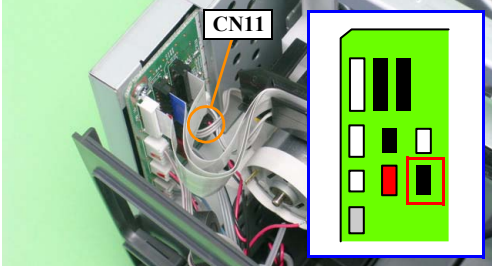
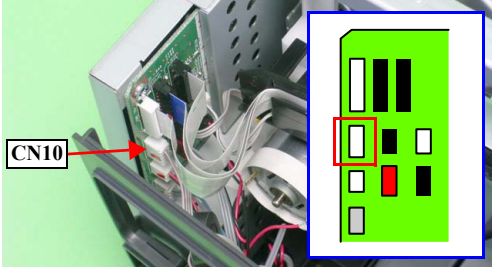
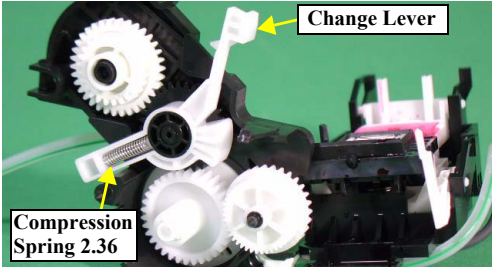
Table 1-7. Troubleshooting of Paper Out Error based on Observed Symptom

Occurrence Timing CR Position	Symptoms	Failed Part	Check Point	Remedies
<ul style="list-style-type: none"> • Occurrence Timing: During operation • CR Position: --- 	<p>The LD Roller shaft rotates to feed paper, but the Hopper does not operate.</p>	<p>ASF Assy.</p>	<p>1. Check the Hopper if it works properly during feeding paper.</p> 	<p>1. Reattach the Compression Spring 2.51 between the ASF Frame and the Hopper properly.</p>
	<p>The LD Roller shaft rotates properly, but the paper is not fed at all.</p>	<p>Shaft Assy. Holder</p>	<p>1. Check the LD Roller surface if it is free of paper dust.</p> 	<p>1. Wipe the paper dust on the LD Roller with a clean cloth moistened with alcohol.</p> <p>* If the problem still occurs after performing the above remedies, replace the LD Roller with a new one.</p>

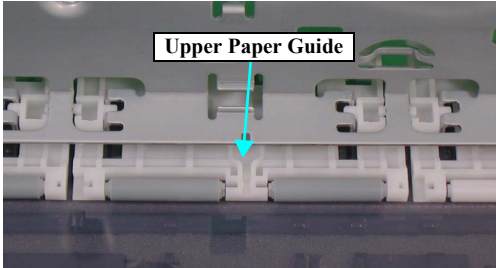
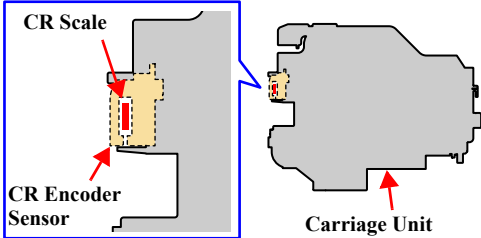
Table 1-7. Troubleshooting of Paper Out Error based on Observed Symptom (continued)

Occurrence Timing CR Position	Symptoms	Failed Part	Check Point	Remedies
<ul style="list-style-type: none"> • Occurrence Timing: During operation • CR Position: --- 	The PF Motor drive cannot be transmitted to the LD Roller Shaft.	Shaft Assy. Holder	1. Check if the Extension Spring 0.143 in the clutch mechanism has not come off. 	1. Attach the Extension Spring 0.143 to the clutch mechanism properly.
		2. Check if the Clutch is properly engaged with the LD Roller Shaft with the guide pin on the shaft.	2. Properly set the hole of the Clutch onto the guide pin of the LD Roller Shaft.	
		3. Check if the Clutch teeth are damaged.	3. Replace the Shaft Assy. Holder with a new one.	
		4. Check if the Clutch is damaged.	4. Replace the Shaft Assy. Holder with a new one.	
		Ink System	1. Check if the Compression Spring 2.36 in the Change Lever has not come off. 	1. Replace the Ink System with a new one.
The LD Roller Shaft cannot be set at the ASF home position and paper is always fed from the ASF Assy.	Ink System	1. Check if the tip of the Change Lever is damaged.	1. Replace the Ink System with a new one.	

Table 1-8. Troubleshooting of Paper Jam Errors based on Observed Symptom

Occurrence Timing CR Position	Symptoms	Failed Part	Check Point	Remedies
<ul style="list-style-type: none"> • Occurrence Timing: During operation • CR Position: Anywhere other than home position 	Paper feeding operation is performed properly, but the paper cannot be sent into the printer.	ASF Assy.	1. Check if the ASF Assy. is properly installed. 2. Check the Paper Back Lever if it works properly during feeding paper. 	1. Reassemble the ASF Assy. correctly. 2. Reinstall the Paper Back Lever and the Torsion Spring 6.45 correctly.
		Shaft Assy. Holder	1. Check if the Torsion Spring 0.22 is properly attached. 	1. Reinstall the PE Sensor Lever and the Torsion Spring 0.22 correctly.
	Multi-feed occurs frequently.	ASF Assy.	1. Check the Retard Roller Assy. if it works properly during feeding paper. 	1. Attach the Extension Spring 0.45 properly to the backside of the Retard Roller Assy.

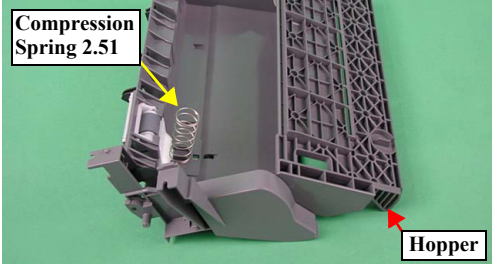
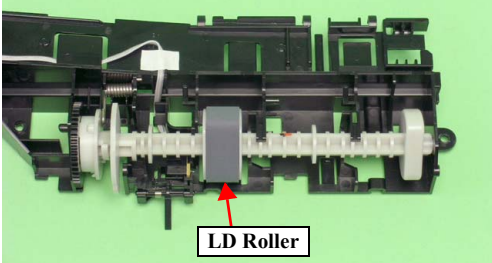
Table 1-8. Troubleshooting of Paper Jam Errors based on Observed Symptom (continued)

Occurrence Timing CR Position	Symptoms	Failed Part	Check Point	Remedies
<ul style="list-style-type: none"> • Occurrence Timing: During operation • CR Position: Anywhere other than home position 	Paper is fed into the printer, but it is ejected immediately.	PE Sensor	1. Check if the Torsion Spring 0.22 is properly attached. 	1. Engage the PE Sensor Lever and the Torsion Spring 0.22 properly.
			2. Check if the PE Sensor cable is correctly connected to CN4 on the Main Board. 	2. Correctly connect the PE Sensor cable to CN4 on the Main Board.
			3. Check if the PE Sensor is damaged.	3. Replace the PE Sensor with a new one.
<ul style="list-style-type: none"> • Occurrence Timing: During operation • CR Position: --- 	Paper edge cannot go through between the EJ Roller and the Star Wheels.	Front Paper Guide Porous Pad	1. Check if the Front Paper Guide Porous Pad is properly installed. 	1. Install the Front Paper Guide Porous Pad properly.

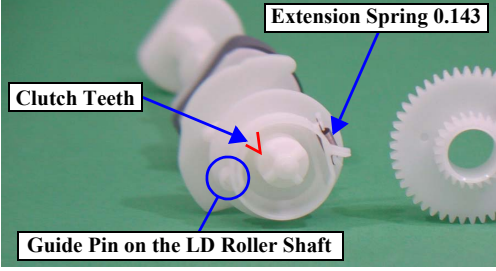
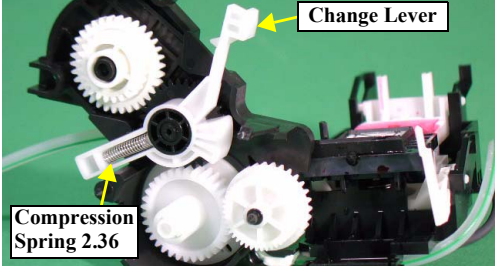
Table 1-8. Troubleshooting of Paper Jam Errors based on Observed Symptom (continued)

Occurrence Timing CR Position	Symptoms	Failed Part	Check Point	Remedies
<ul style="list-style-type: none"> • Occurrence Timing: During operation • CR Position: --- 	Paper edge cannot go through between the EJ Roller and the Star Wheels.	EJ Frame Assy.*	1. Check if the Star Wheel Holder has not come off. 	1. Install the Star Wheel Holder correctly.
		2. Check if the EJ Frame Assy. is properly installed.	2. Install the EJ Frame Assy. correctly.	
		3. Check the EJ Frame Assy. for deformation (if it warped downward).	3. Replace the EJ Frame Assy. with a new one.	
		Spur Gear 41.38*	1. Check if the Spur Gear 41.38 is damaged. 	1. Replace the Spur Gear 41.38 with a new one.
EJ Roller Assy.*	1. Check if the EJ Roller Assy. is properly installed. 	1. Install the EJ Roller Assy. correctly.		

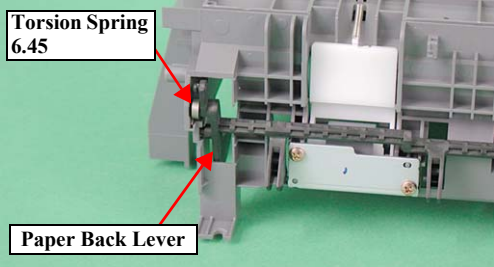
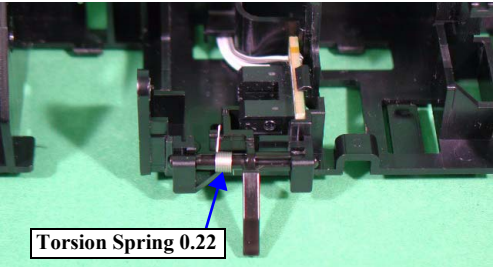
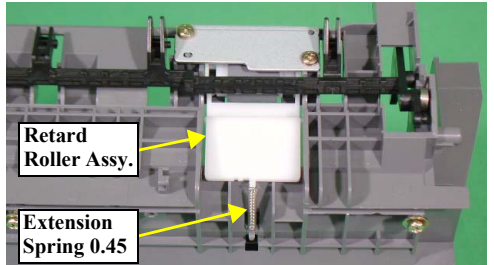
* Jammed paper sometimes contacts with the Print Head and can damage the head.

Table 1-8. Troubleshooting of Paper Jam Errors based on Observed Symptom (continued)

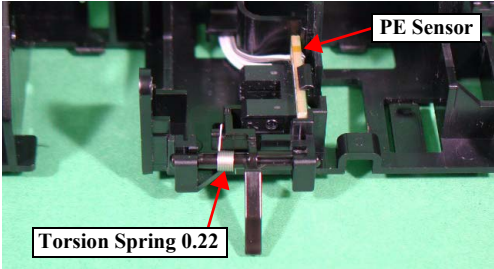
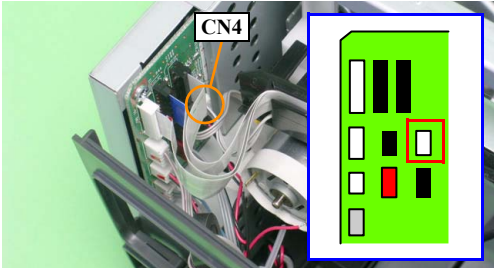
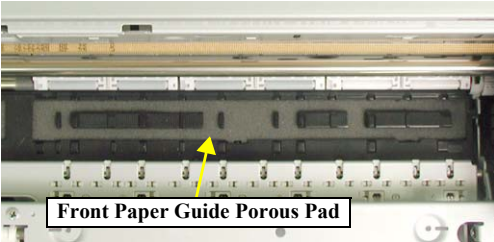
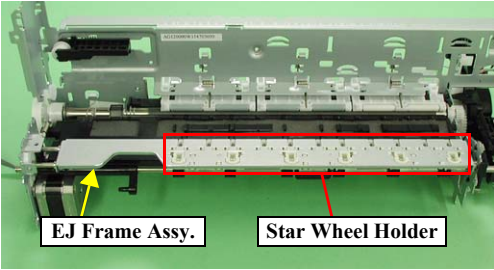
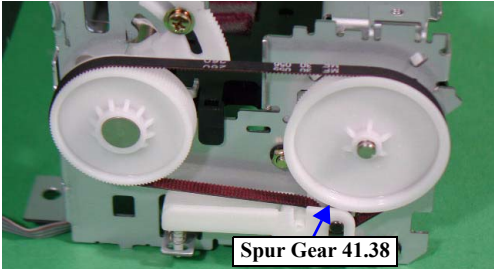
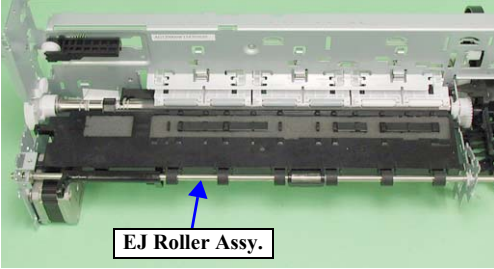
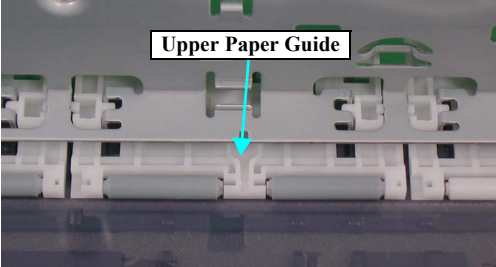
Occurrence Timing CR Position	Symptoms	Failed Part	Check Point	Remedies
<ul style="list-style-type: none"> • Occurrence Timing: During operation • CR Position: --- 	Top edge of paper cannot be sent to the PF Roller.	Upper Paper Guide*	1. Check if the Upper Paper Guide has not come off the Main Frame. 	1. Install the Upper Paper Guide correctly.

* Jammed paper sometimes contacts with the Print Head and can damage the head.

Table 1-9. Troubleshooting of Errors at Opening the CD/DVD Guide based on Observed Symptom

Occurrence Timing CR Position	Symptoms	Failed Part	Check Point	Remedies
<ul style="list-style-type: none"> • Occurrence Timing: At power-on • CR Position: Home position 	The CD/DVD guide open error occurs at power-on even though the CDR Guide Assy. is held closed.	Upper Housing	1. Check if the Tray/CDR Sensor flag on the Upper Housing is broken. 	1. Replace the Upper Housing with a new one.
		Tray/CD-R Sensor	1. Check if the Tray/CDR Sensor cable is correctly connected to CN2 on the Main Board. 	1. Correctly connect the Tray/CDR Sensor cable to CN2 on the Main Board.
			2. Check if the Tray/CDR Sensor is damaged. 	2. Replace the Tray/CDR Sensor with a new one.
			3. Check if the Tray/CDR Sensor cable is broken.	3. Replace the Tray/CDR Sensor with a new one.

Table 1-9. Troubleshooting of Errors at Opening the CD/DVD Guide based on Observed Symptom (continued)

Occurrence Timing CR Position	Symptoms	Failed Part	Check Point	Remedies
<ul style="list-style-type: none"> • Occurrence Timing: At power-on • CR Position: Home position 	The CD/DVD guide open error occurs at power-on even though the CDR Guide Assy. is held closed.	Stacker Lock	1. Check if the Stacker Lock and the Compression Spring 5.1 are properly engaged. 	1. Engage the Stacker Lock and the Compression Spring 5.1 properly.
		CDR Sensor Lever	2. Check if the CDR Sensor Lever and the Torsion Spring 4.26 are properly engaged. 	2. Engage the CDR Sensor Lever and the Torsion Spring 4.26 properly.
		Main Board	1. Check if any of the elements on the Main Board is damaged.	1. Replace the Main Board with a new one.

Table 1-10. Troubleshooting of Name Card Insertion Error based on Observed Symptom

Occurrence Timing CR Position	Symptoms	Failed Part	Check Point	Remedies
<ul style="list-style-type: none"> Occurrence Timing: At power-on CR Position: Anywhere other than home position 	The name card insertion error occurs at power-on.	PE Sensor	1. Check if the PE Sensor cable is correctly connected to CN4 on the Main Board. 	1. Correctly connect the PE Sensor cable to CN4 on the Main Board.
<ul style="list-style-type: none"> Occurrence Timing: During operation CR Position: --- 	Even though a name card is properly loaded in landscape orientation, the card edge cannot be sent to the PF Roller.	PW Sensor	1. Check if the PW Sensor FFC is correctly connected to the connectors on the PW Sensor and the CR Encoder Board. 	1. Correctly connect the PW Sensor FFC to the connectors on the PW Sensor and the CR Encoder Board.
		Main Board	1. Check if any of the elements on the Main Board is damaged.	1. Replace the Main Board with a new one.

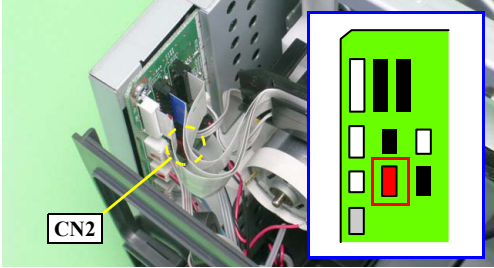
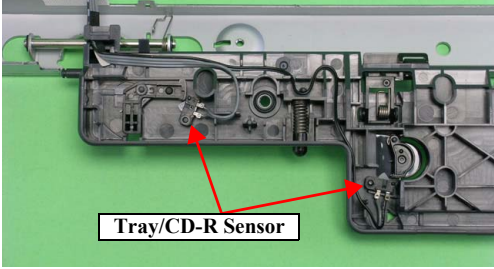
Table 1-11. Troubleshooting of CD/DVD Tray Errors based on Observed Symptom

Occurrence Timing CR Position	Symptoms	Failed Part	Check Point	Remedies
<ul style="list-style-type: none"> • Occurrence Timing: During operation • CR Position: --- 	A CD/DVD Tray error occurs when attempting to print on a CD or DVD even though the CDR Tray is properly attached.	CD-R Tray	1. Check if the contact portion of the CDR Tray Sensor on the CDR Tray is broken. 	1. Replace the CDR Tray Sensor with a new one.
		Tray Sensor Lever	2. Check if the Tray Sensor Lever and the Torsion Spring 2.8 are properly engaged. 	2. Engage the Tray Sensor Lever and the Torsion Spring 2.8 properly.

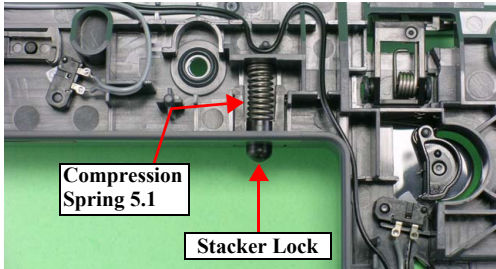
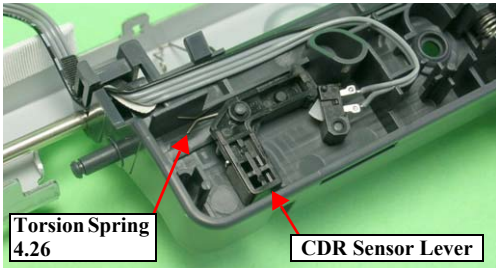
Table 1-11. Troubleshooting of CD/DVD Tray Errors based on Observed Symptom (continued)

Occurrence Timing CR Position	Symptoms	Failed Part	Check Point	Remedies
<ul style="list-style-type: none"> • Occurrence Timing: During operation • CR Position: --- 	The CDR Tray center detection sequence is canceled and the CDR Tray is ejected.	CDR Tray	1. Check the white marking on the CDR Tray for any paper dust or contamination.  A photograph of a CDR tray with a white marking on its surface. A yellow circle highlights the marking, and a label 'White Marking' points to it.	1. Clean the white marking area on the CDR Tray.
		PW Sensor	1. Check the PW Sensor for paper dust or ink stain.  A close-up photograph of the PW sensor area. A red arrow points to the sensor, and a label 'PW Sensor' is placed above it.	1. Clean the surface of the PW Sensor.
			2. Check if the PW Sensor FFC is correctly connected to the connectors on the PW Sensor and the CR Encoder Board.  A photograph showing the connection between the PW sensor and the CR encoder board. A yellow circle highlights the connector on the sensor, and a label 'Connector' points to it. Another yellow circle highlights the FFC on the board, and a label 'PW Sensor FFC' points to it. An inset image shows the 'CR Encoder Board' with a yellow arrow pointing to the FFC connection point.	2. Correctly connect the PW Sensor FFC to the connectors on the PW Sensor and the CR Encoder Board.
			3. Check the PW Sensor FFC for any damage.	3. Replace the PW Sensor FFC with a new one.
			4. Check the PW Sensor for any damage.	4. Replace the PW Sensor with a new one.
Main Board	1. Check if any of the elements on the Main Board is damaged.	1. Replace the Main Board with a new one.		

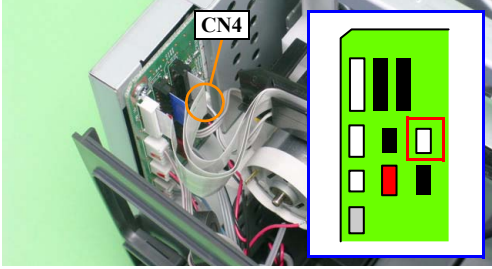
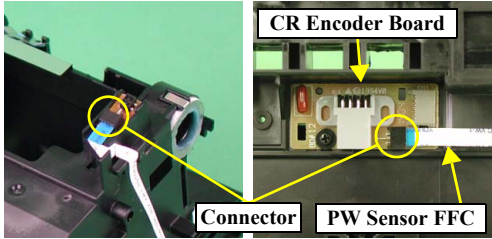
1.3.2 Troubleshooting by Observed Symptom

Table 1-12. Multi-Feed Occurs with No Error Messages displayed on the LCD or STM3 screen

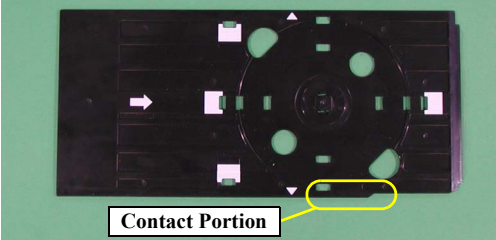
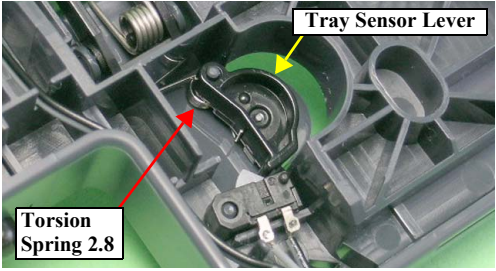
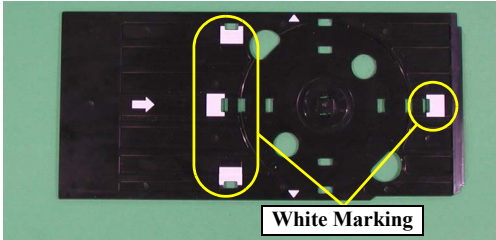
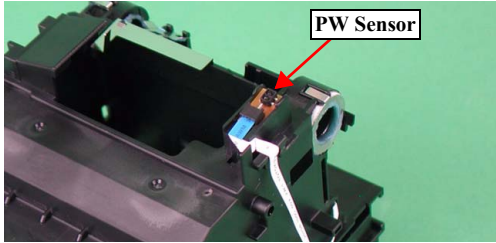
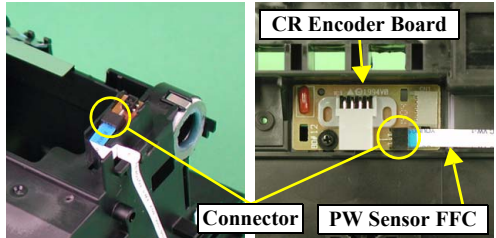
Occurrence Timing CR Position	Symptoms	Failed Part	Check Point	Remedies
<ul style="list-style-type: none"> • Occurrence Timing: During operation • CR Position: --- 	<p>Multiple sheets are always fed at a time from the ASF Assy., but no error messages are displayed on the LCD or the STM3 screen.</p>	<p>ASF Assy.</p>	<ol style="list-style-type: none"> 1. Check the Retard Roller Assy. if it works properly during feeding paper.  <ol style="list-style-type: none"> 2. Check the Paper Back Lever if it works properly during feeding paper. 	<ol style="list-style-type: none"> 1. Attach the Extension Spring 0.45 properly to the backside of the Retard Roller Assy. 2. Reinstall the Paper Back Lever and the Torsion Spring 6.45 correctly.

Table 1-13. Abnormal Noises are Produced during Operation

Occurrence Timing CR Position	Symptoms	Failed Part	Check Point	Remedies
<ul style="list-style-type: none"> • Occurrence Timing: Anytime • CR Position: Anywhere 	Printing operations are performed properly, but abnormal noises are produced after turning the power On and during operations.	Carriage Unit	1. Check if the CR Guide Shaft is properly lubricated.	1. Wipe off the remaining oil on the CR Guide Shaft and re-lubricate the shaft properly.
		Ink System	1. Check if the Change Lever moves smoothly.	1. Replace the Ink System with a new one.
	The bottom of the Carriage Unit comes into contact with the surface of the Front Frame.	EJ Frame Assy.	1. Check if the EJ Frame Assy. has warped upward.	1. Replace the EJ Frame Assy. with a new one.
	The Carriage Unit hits against the Upper Paper Guide while the Carriage Unit is moving.	Upper Paper Guide	1. Check if the Upper Paper Guide has not come off the Main Frame.	1. Install the Upper Paper Guide correctly.

Table 1-14. Print Quality Problems

Problems	Description	Failed Part	Check Point	Remedies
<ul style="list-style-type: none"> • Dot missing • Mixed colors, • Blank pages 	Ink cannot be discharged from the Print Head to the Cap.	Ink System (Cap Unit)	1. Check the shielding rubber of the Cap Unit for any damage or foreign material.	1. Remove the foreign material from the shielding rubber. * If the Ink System is damaged, replace it with a new one.
			2. Check if the Compression Spring 2.53 is properly attached.	

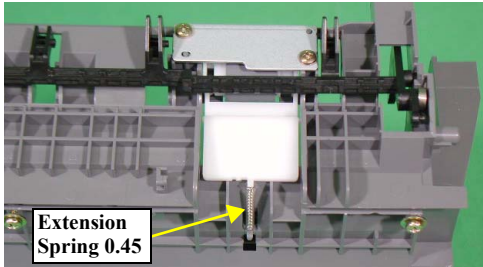
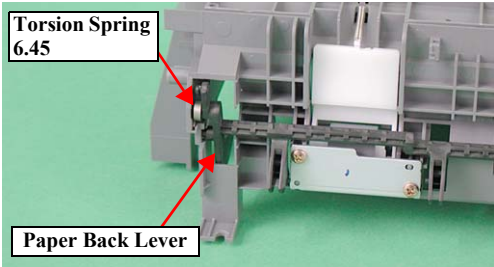
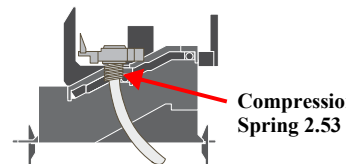
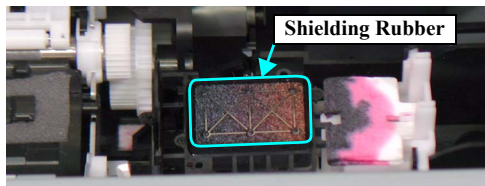

Table 1-14. Print Quality Problems (continued)

Problems	Description	Failed Part	Check Point	Remedies
<ul style="list-style-type: none"> Dot missing Mixed colors Blank Pages 	Although ink is properly discharged from the Print Head to the Cap, the problem still occurs even after executing a head cleaning or replacing ink cartridges.	Print Head	1. Check if the printer recovers from the error by the head cleaning or ink cartridges replacement. 2. Check the Print Head for any damage.	1. Execute the head cleaning and ink cartridges replacement the specified number of times. If the problem still occurs, replace the Print Head with a new one. 2. Replace the Print Head with a new one.
		Head Cleaner	1. Check the Head Cleaner for paper dust or deformation.	1. Replace the Ink System Unit with a new one.
		Main Board	1. Check the Main Board for any damage.	1. Replace the Main Board Assy. with a new one.
<ul style="list-style-type: none"> Too much ink is discharged 	Ink is properly discharged from the Print Head to the Cap, but nothing is printed even after executing a head cleaning or replacing ink cartridges. Or too much ink is discharged.	Head Cable	1. Check if the Head Cable is correctly connected to the connector on the Print Head and CN7/CN8 connectors on the Main Board.	1. Correctly connect the Head Cable to the connector on the Print Head and CN7/CN8 connectors on the Main Board.
				
		Print Head	1. Check if the printer recovers from the error by the head cleaning or ink cartridges replacement.	1. Execute the head cleaning and ink cartridges replacement the specified number of times. If the problem still occurs, replace the Print Head with a new one.
Main Board	1. Check the Main Board for any damage.	1. Replace the Main Board Assy. with a new one.		

Table 1-14. Print Quality Problems (continued)

Problems	Description	Failed Part	Check Point	Remedies	
<ul style="list-style-type: none"> White bands/Color unevenness 	<p>Vertical bands (perpendicular to the CR moving direction) appear on printouts with inconsistencies in density.</p>  <p>(Note) If the problem still occurs after the all actions to remedy it have taken, replace the CR Motor with a new one.</p>	Print Head	1. Print a nozzle check pattern and examine the printout patterns for any missing segments or broken lines.	1. Run a head cleaning and then print a nozzle check pattern again. (See Chapter 3 for details on the adjustments) If the problem still occurs, replace the Print Head with a new one.	
		Adjustment	1. If the problem occurs in the Bi-D mode, verify that the Bi-D adjustment is made properly.	1. Perform the Bi-D adjustment to align the bi-directional print positions. (See Chapter 3 for details on the adjustments)	
		Carriage Unit/ CR Guide Shaft	1. Check the CR Guide Shaft surface for any foreign matters.	1. Remove the foreign matters on the surface of the CR Guide Shaft.	
			2. Check if the CR Guide Shaft is properly secured to the Main Frame with the CR Shaft Fixing Spring.	2. Install the CR Guide Shaft correctly.	
			3. Check if the CR Guide Shaft surface is properly lubricated.	3. Wipe off the remaining oil on the CR Guide Shaft with a dry soft cloth, and re-lubricate the shaft with G-63 oil. (See Chapter 4 for details on the lubrication)	
			4. Check the CR Guide Shaft surface for any damages.	4. Replace the CR Guide Shaft with a new one.	
EJ Frame Assy.	1. Check if the EJ Frame Assy. surface stays in a horizontal position.	1. Replace the EJ Frame Assy. with a new one.			
<ul style="list-style-type: none"> Horizontal bands (horizontal to the CR moving direction) appear on printouts. 	 <p>(Note) If the problem still occurs after the all actions to remedy it have taken, replace the PF Motor with a new one.</p>	Print Head	1. Print a nozzle check pattern and examine the printout patterns for any missing segments or broken lines.	1. Run a head cleaning and then print a nozzle check pattern again. (See Chapter 3 for details on the adjustments) If the problem still occurs, replace the Print Head with a new one.	
		Printer driver and Special paper	1. Check if appropriate type of paper is used in accordance with the printer driver setting.	1. Use an appropriate type of paper in accordance with the printer driver setting.	
		PF Roller Assy.	1. Check the PF Roller surface for any foreign matters.		1. Clean the surface of the PF Roller properly with a soft cloth.
			2. Check if the PF Roller Assy. is damaged.		2. Replace the PF Roller Assy. with a new one.

Table 1-14. Print Quality Problems (continued)

Problems	Description	Failed Part	Check Point	Remedies
<ul style="list-style-type: none"> White bands/Color unevenness 	A vertical (perpendicular to the CR moving direction) white line (trace of Star Wheel) appears on printouts. 	EJ Frame Assy.	1. Check if the Star Wheel Holder has not come off. 	1. Install the Star Wheel Holder correctly.
			2. Check if the EJ Frame Assy. surface stays in a horizontal position.	2. Replace the EJ Frame Assy. with a new one.
	Printouts are faint	Printer driver and Special paper	1. Check if appropriate type of paper is used in accordance with the printer driver setting.	1. Use an appropriate type of paper in accordance with the printer driver setting.
		Print Head	1. Check if the Head ID written in the EEPROM is correct using the Adjustment Program.	1. Write the correct 15-digit Head ID to the EEPROM with the Adjustment Program.
<ul style="list-style-type: none"> Displacement of the print start position 	Printing operations are performed properly, but the top margin is narrower than usual.	Shaft Assy. Holder	1. Check the LD Roller surface if it is free of paper dust. 	1. Wipe the paper dust on the LD Roller with a clean cloth moistened with alcohol. * If the problem still occurs after performing the above remedies, replace the LD Roller with a new one.

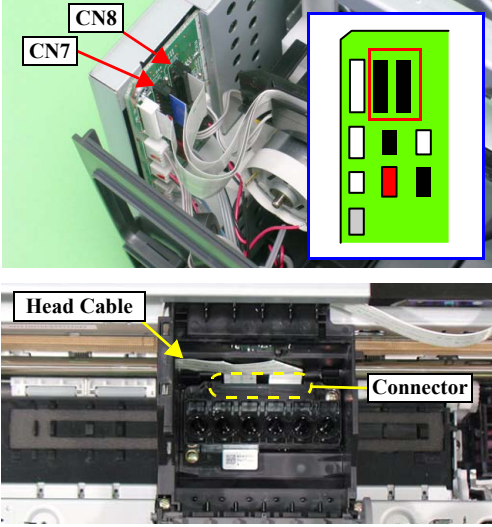
Table 1-14. Print Quality Problems (continued)

Problems	Description	Failed Part	Check Point	Remedies
<ul style="list-style-type: none"> Ink smudges 	Ink smudges appear on the top and bottom edges and backside of printouts.	Front Paper Guide Porous Pad	1. Check if any part of the Front Paper Guide Porous Pad is separated from the Front Paper Guide. 	1. Bring the Front Paper Guide Porous Pad into intimate contact with the Front Paper Guide. * Replace the pad with a new one if it is badly deformed.
		Front Paper Guide	1. Check the Front Paper Guide for any ink stains.	1. Clean the Front Paper Guide properly with a soft cloth.
		EJ Roller Assy.	1. Check the EJ Roller Assy. for any ink stains.	1. Clean the EJ Roller Assy. properly with a soft cloth.
		PF Roller Assy.	1. Check the PF Roller Assy. for any ink stains.	1. Clean the PF Roller Assy. properly with a soft cloth.
	Ink smudges appear on non-printed area of printouts.	Print Head	1. Check the Print Head Cover for any ink drops.	1. Clean the Print Head Cover properly with a soft cloth.
		Upper Paper Guide	1. Check the Upper Paper Guide for any ink stains.	1. Clean the Upper Paper Guide properly with a soft cloth.
EJ Frame Assy.		1. Check the EJ Frame Assy. for any ink stains.	1. Clean the EJ Frame Assy. properly with a soft cloth.	
<ul style="list-style-type: none"> Wrinkles 	Top side of printouts is wrinkled.	ASF Assy.	1. Check if the Hopper Pad is properly attached to the Hopper. 	1. Replace the ASF Assy. with a new one.

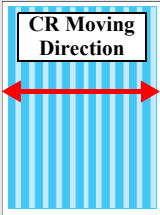
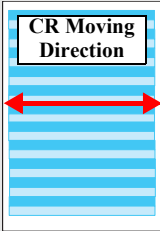
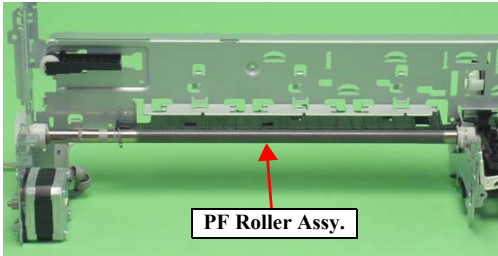
CHAPTER

2

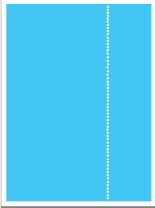
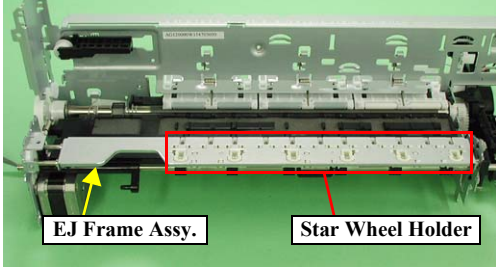
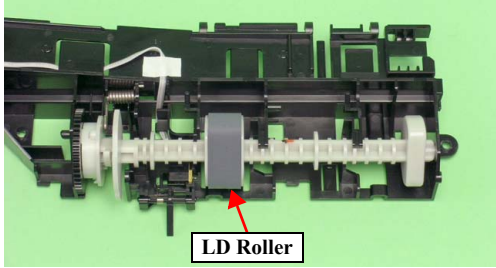
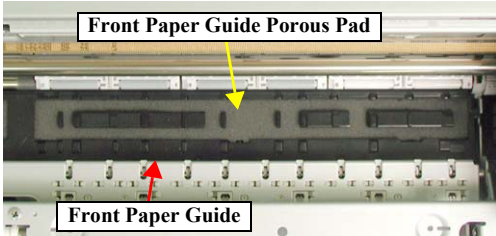
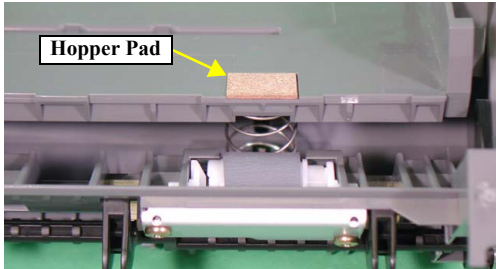
DISASSEMBLY AND ASSEMBLY

2.1 Overview

This chapter describes procedures for disassembling the main components of the Stylus Photo R340/350. Unless otherwise specified, disassembled units or components can be reassembled by reversing the disassembly procedure.

Procedures which, if not strictly observed, could result in personal injury are described under the heading "WARNING".

"CAUTION" signals a precaution which, if ignored, could result in damage to equipment.

Important tips for procedures are described under the heading "CHECK POINT".

If the assembly procedure is different from the reversed disassembly procedure, the correct procedure is described under the heading "REASSEMBLY".

Any adjustments required after reassembly of components or parts are described under the heading "ADJUSTMENT REQUIRED".

When you have to remove any parts or components that are not described in this chapter, refer to the exploded diagram supplied with a separate parts list.

Read the precautions described in the next section before starting.

2.1.1 Precautions

The precautions in the two lists below (WARNING and CAUTION) must always be followed during disassembly and assembly.



- Disconnect the power cable before disassembling or assembling the printer.
- If you need to work on the printer with power applied, strictly follow the instructions in this manual.
- Always wear goggles to protect your eyes from splattering of ink. If ink gets in your eye, flush the eye with fresh water and see a doctor immediately.
- Always wear gloves for disassembly and reassembly to avoid injury from sharp metal edges.
- Use static discharge equipment such as anti-static wrist straps when accessing internal components to protect sensitive electronic components and circuitry.
- Never touch the ink or wasted ink with bare hands. If ink comes into contact with your skin, wash it off with soap and water immediately. If irritation occurs, contact a physician.
- Make sure the tip of the waste ink tube is located at correct position when reassembling the waste ink tube, or it will cause ink leakage.



- When transporting the printer on which the ink cartridges have been installed, secure the cartridges with pieces of tape to the printer cover so that they do not move from the home position.
- Use only recommended tools for disassembly, assembly or adjustment of the printer. See [Table 2-1 "Tools" on page 38](#).
- When using compressed air products; such as air duster, for cleaning during repair and maintenance, the use of such products containing flammable gas is prohibited.
- When tightening screws, be sure to observe the specified tightening torque.
- Apply lubricants and adhesives as specified. (See Chapter 4 for details.)
- Make the specified adjustments when you disassemble the printer. (See Chapter 3 for details.)

2.1.2 Tools

Use only specified tools to avoid damaging the printer.

Table 2-1. Tools

Tool	Supplier	Part Number
Phillips Screw Driver (No. 0)	EPSON	1080531
Phillips Screw Driver (No. 1)	EPSON	1080530
Phillips Screw Driver (No. 2)	EPSON	1080532
Tweezers	EPSON	1080561
Acetate Tape	EPSON	1003963

2.1.3 Work Completion Checklist

Whenever the printer is serviced, use the checklist shown below to confirm all work is complete properly and the printer is ready to be returned to the user.

Table 2-2. Work Completion Checklist

Classification	Item	Check Point	Status
Main Unit	Self-test	Is the operation normal?	<input type="checkbox"/> Checked
			<input type="checkbox"/> Not necessary
	On-line Test	Is the printing attempt successful?	<input type="checkbox"/> Checked
			<input type="checkbox"/> Not necessary
	Print Head	Is ink discharged normally from all the nozzles?	<input type="checkbox"/> Checked
			<input type="checkbox"/> Not necessary
	Carriage Mechanism	Does it move smoothly?	<input type="checkbox"/> Checked
<input type="checkbox"/> Not necessary			
Is there any abnormal noise during its operation?			<input type="checkbox"/> Checked
	<input type="checkbox"/> Not necessary		
Carriage Mechanism	Are there any foreign objects or dirt on the CR Guide Shaft?	<input type="checkbox"/> Checked	
		<input type="checkbox"/> Not necessary	

Table 2-2. Work Completion Checklist

Classification	Item	Check Point	Status
Main Unit	Carriage Mechanism	Is the CR Motor at the correct temperature? (Not too hot to touch?)	<input type="checkbox"/> Checked
			<input type="checkbox"/> Not necessary
	Paper Feeding Mechanism	<ul style="list-style-type: none"> • Is paper fed smoothly? • No paper jamming? • No paper skew? • No multiple-sheet feeding? • No abnormal noise? 	<input type="checkbox"/> Checked
			<input type="checkbox"/> Not necessary
Main Unit	Paper Feeding Mechanism	Is the PF Motor at the correct temperature? (Not too hot to touch?)	<input type="checkbox"/> Checked
			<input type="checkbox"/> Not necessary
Main Unit	Paper Feeding Mechanism	Is the paper path free of any obstructions?	<input type="checkbox"/> Checked
			<input type="checkbox"/> Not necessary
Adjustment	Specified Adjustment	Are all the adjustments correctly completed?	<input type="checkbox"/> Checked <input type="checkbox"/> Not necessary
Lubrication	Specified Lubrication	Has lubrication been applied at the specified points?	<input type="checkbox"/> Checked <input type="checkbox"/> Not necessary
		Is the amount of lubrication correct?	<input type="checkbox"/> Checked <input type="checkbox"/> Not necessary
Function	ROM Version	Is it the latest version? Version:	<input type="checkbox"/> Checked <input type="checkbox"/> Not necessary
Packing	Ink Cartridge	Are the ink cartridges installed correctly?	<input type="checkbox"/> Checked <input type="checkbox"/> Not necessary
	Protective Materials	Have all relevant protective/ packing materials been attached to the printer?	<input type="checkbox"/> Checked <input type="checkbox"/> Not necessary
Others	Attachments, Accessories	Have all the relevant items been included in/ returned to the package?	<input type="checkbox"/> Checked <input type="checkbox"/> Not necessary

2.2 Ensuring the Quality of Disassembled/ Reassembled Printer Mechanism

Removing the Lower Housing from the Printer Mechanism has been basically prohibited for the conventional low-end printers. Because the Main Frame of those printers is not so strong that it may be deformed due to the force exerted on it during removing or reinstalling the Lower Housing. Whenever the Ink System or the PF Motor of the low-end printers must be replaced, we have recommended to replace the Printer Mechanism together with the Lower Housing.

However, on the other hand, the Stylus Photo R340/350 require to remove the Lower Housing from the Printer Mechanism to replace the Waste Ink Pad or the Ink System. Whenever the Printer Mechanism is separated from the Lower Housing, be sure to perform the reassembly following the cautions and instructions described in this section to ensure the quality of reassembled printers.

□ Cautions on Disassembly/Reassembly of Printer Mechanism

1. When the Printer Mechanism is removed together with the Lower Housing
 - Do not hold the CR Guide Plate to lift or move the removed components, or the CR Guide Plate and the Main Frame may be deformed and adversely affect the print quality.
 - Never touch the CR Guide Shaft and the nozzles on the head.
2. When the Printer Mechanism is separated from the Lower Housing
 - Make sure to reinstall the Printer Mechanism to the Lower Housing carefully observing the correct positions described in the next bulleted paragraphs.
 - Be sure to first remove the Main Frame Support Plate, and then remove the PF Roller Assy., EJ Roller Assy., and the Front Paper Guide.
 - Make sure the tip of the Waste Ink Tube is located at correct position.
 - Make sure that the connector cable of the Tray/CD-R Sensor are properly routed.
 - Make sure that the APG gears are properly engaged.

■ Printer Mechanism Positioning Requirements

[Purpose]

Displacement of the Printer Mechanism can cause print quality or any other troubles. The correct installation position must be ensured by carefully checking the specified points in relation to the Lower Housing.

[When Servicing]

Make sure there is no gap between the Main Frame and the Lower Housing.

[Tip]

To ensure the correct position of the Printer Mechanism, it must be checked in X, Y, and Z directions as described below.

[X direction]

- Make sure that the bottom edge of the Main Frame is properly inserted into the groove on the Lower Housing.
- Make sure there is no gap between the Main Frame and the Lower Housing.

[Y direction]

- Make sure that the notches of the Main Frame are properly engaged with the protrusions on the Lower Housing.

[Z direction]

- Make sure there is no gap between the Main Frame and the Lower Housing.
- Make sure that the Printer Mechanism is properly secured with the four hooked tabs (two on the left side, one on the right side, and one on the right front side).

■ CR Guide Plate Perpendicularity Requirements

[Purpose]

The L-shaped CR Guide Plate supports the Carriage Unit perpendicular to the CR Shaft. Any deformation of the CR Guide Plate can cause an inclination of the Carriage Unit resulting in print troubles or a malfunction of the printer, so the perpendicularity of the CR Guide Plate must be ensured.

[When Servicing]

Make sure to hold the Main Frame by the specified points to prevent it from deforming.

- Caution on Attaching the ASF Assy., Main Board Assy., and Upper Paper Guide

[Purpose]

To prevent the Main Frame from deforming due to the force exerted on it during attaching the above three parts.

[When Servicing]

When attaching any of the three parts, be sure to support the Main Frame or components behind the part with your hand so that the force to attach the part is not exerted on the frame from only one direction.

3. CD-R Guide Assy.

- CD-R Guide Assy. Perpendicularity Requirements

[Purpose]

Any deformation of the CD-R Guide Assy. can cause print troubles, so the perpendicularity of the CD-R Guide Assy. must be ensured.

[When Servicing]

Disassembling and reassembling the CD-R Guide Assy. should be performed with extreme caution.

□ How to Finally Ensure Quality of Reassembled Printers

Make some test prints using the Adjustment Program. The quality of the reassembled printer is ensured if the print results are satisfactory.

2.3 Disassembly

The flowchart below lists the step-by-step disassembly procedures. When disassembling each unit, refer to the page number shown in the figure.

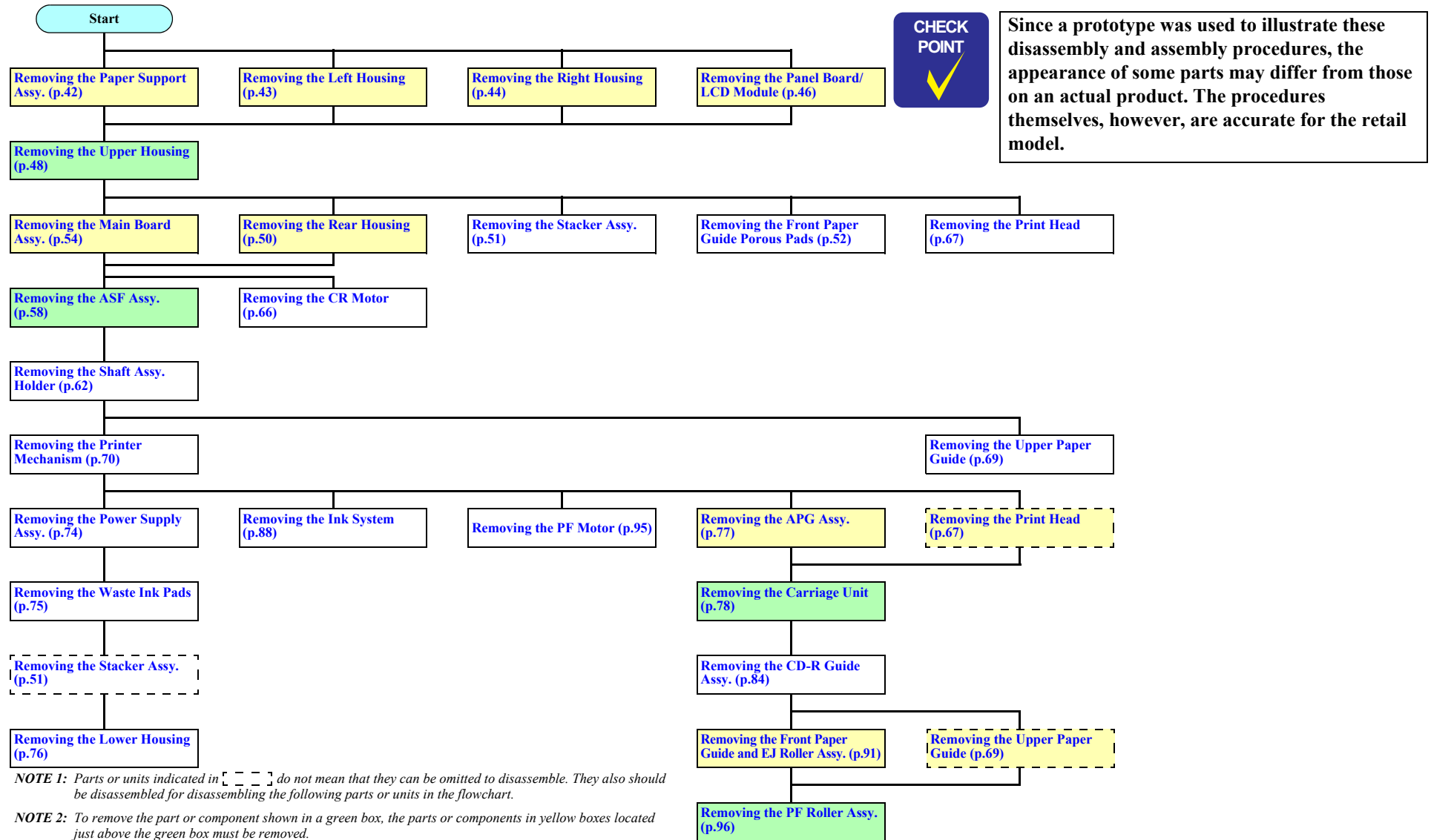

Figure 2-1. Removing Procedure Flowchart

2.3.1 Removing the Paper Support Assy.

□ Illustration

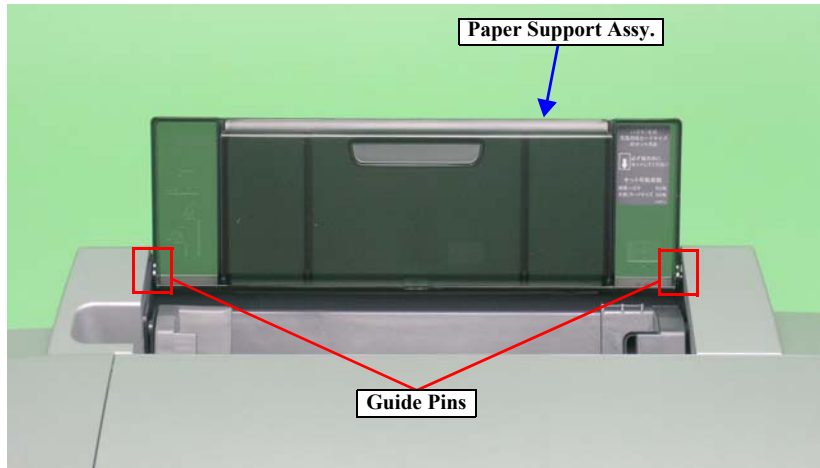

Figure 2-2. Removing the Paper Support Assy.

□ Parts/Components must be removed to remove the Paper Support Assy.

None

□ Disassembly Procedure

1. Release the two guide pins (□) that secure the Paper Support Assy. and remove it.

2.3.2 Removing the Left Housing

□ Illustration

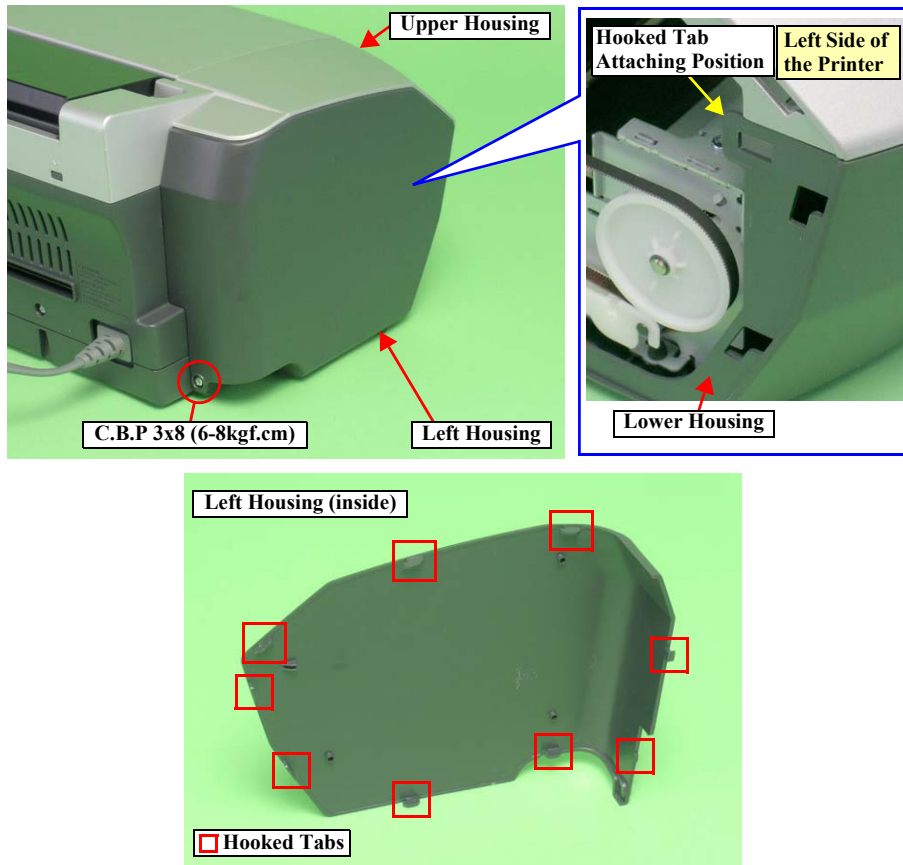

Figure 2-3. Removing the Left Housing

□ Parts/Components must be removed to remove the Left Housing.

None

□ Disassembly Procedure

1. Remove the screw (○) that secures the Left Housing.
2. Open the Printer Cover.
3. Release the hooked tab of the Lower Housing from inside the housing, and then push the Left Housing toward the rear of the printer to release the nine tabs (□), and remove the Left Housing.



Make sure there is no gap between the Left Housing and the Upper Housing.

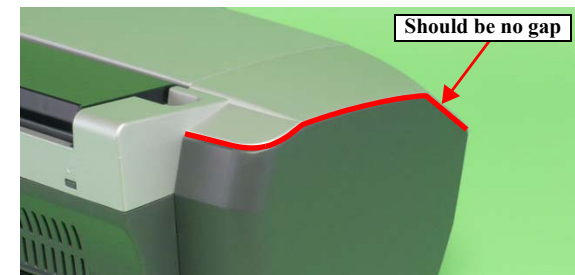

Figure 2-4. Reinstalling the Left Housing

2.3.3 Removing the Right Housing

□ Illustration

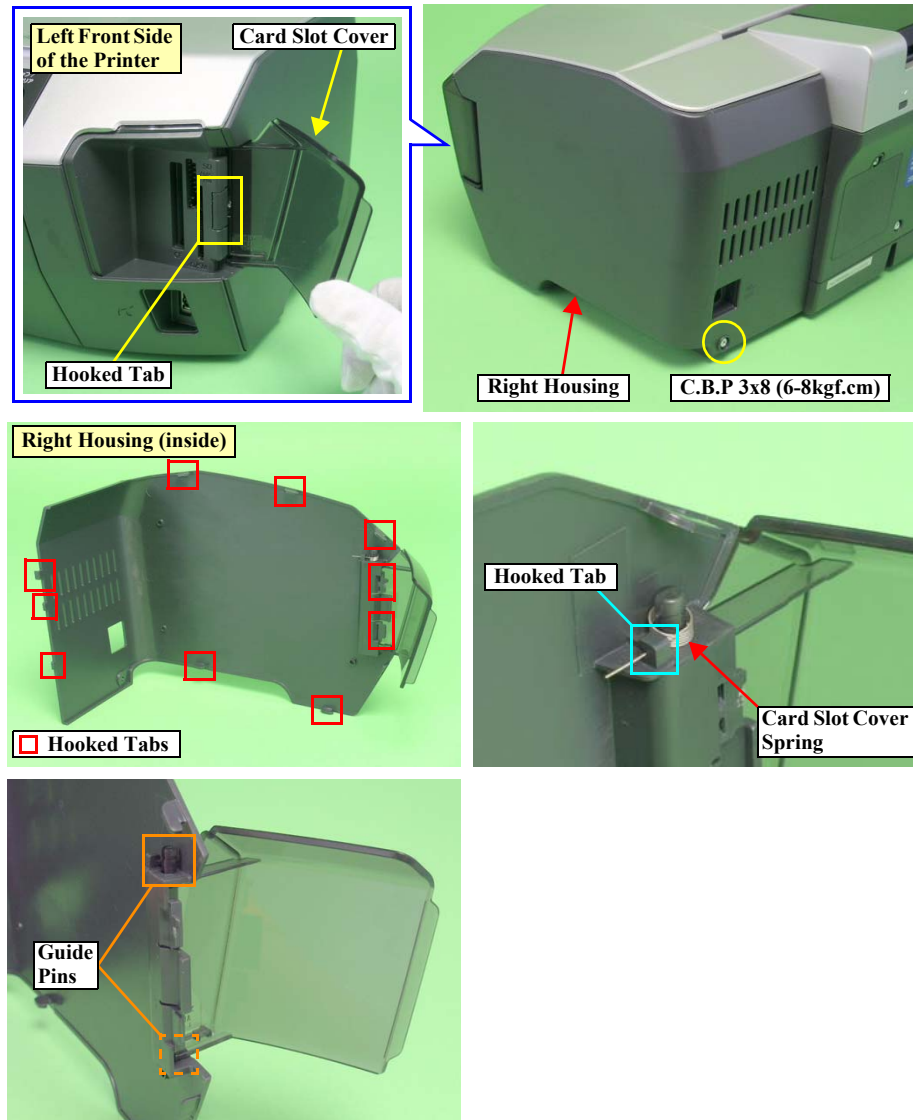

Figure 2-5. Removing the Right Housing

□ Parts/Components must be removed to remove the Right Housing.

None

□ Disassembly Procedure

1. Remove the screw (○) that secures the Right Housing.
2. Open the Card Slot Cover and release the hooked tab (□) that secures the Right Housing.
3. Push the Right Housing toward the rear of the printer to release the ten tabs (□) and remove the Right Housing.
4. Release the longer leg of the Card Slot Cover Spring from the hooked tab (□) on the Right Housing and remove the spring.
5. Pull out the lower guide pin (□) and then the upper guide pin (□) of the Card Slot Cover to remove it.



- Reattaching the Card Slot Cover Spring
 - Insert the shorter leg of the spring into the groove of the upper guide pin (□) of the Card Slot Cover, and secure the longer leg of the spring by the hooked tab (□) on the Right Housing.

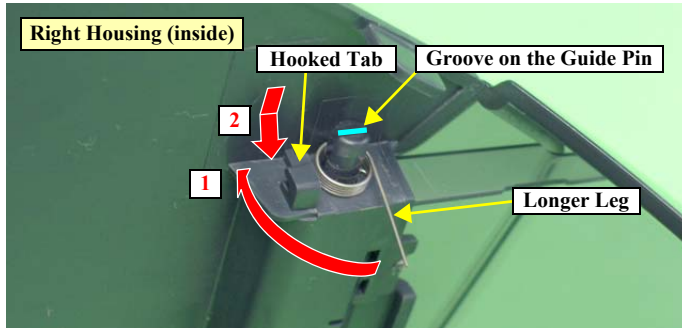

Figure 2-6. Reattaching the Card Slot Cover Spring

- Reinstalling the Right Housing
 - Make sure there is no gap between the Right Housing and the Upper Housing.

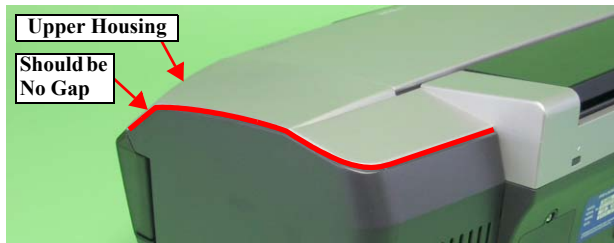

Figure 2-7. Reinstalling the Right Housing

2.3.4 Removing the Panel Board/LCD Module

□ Illustration (1)

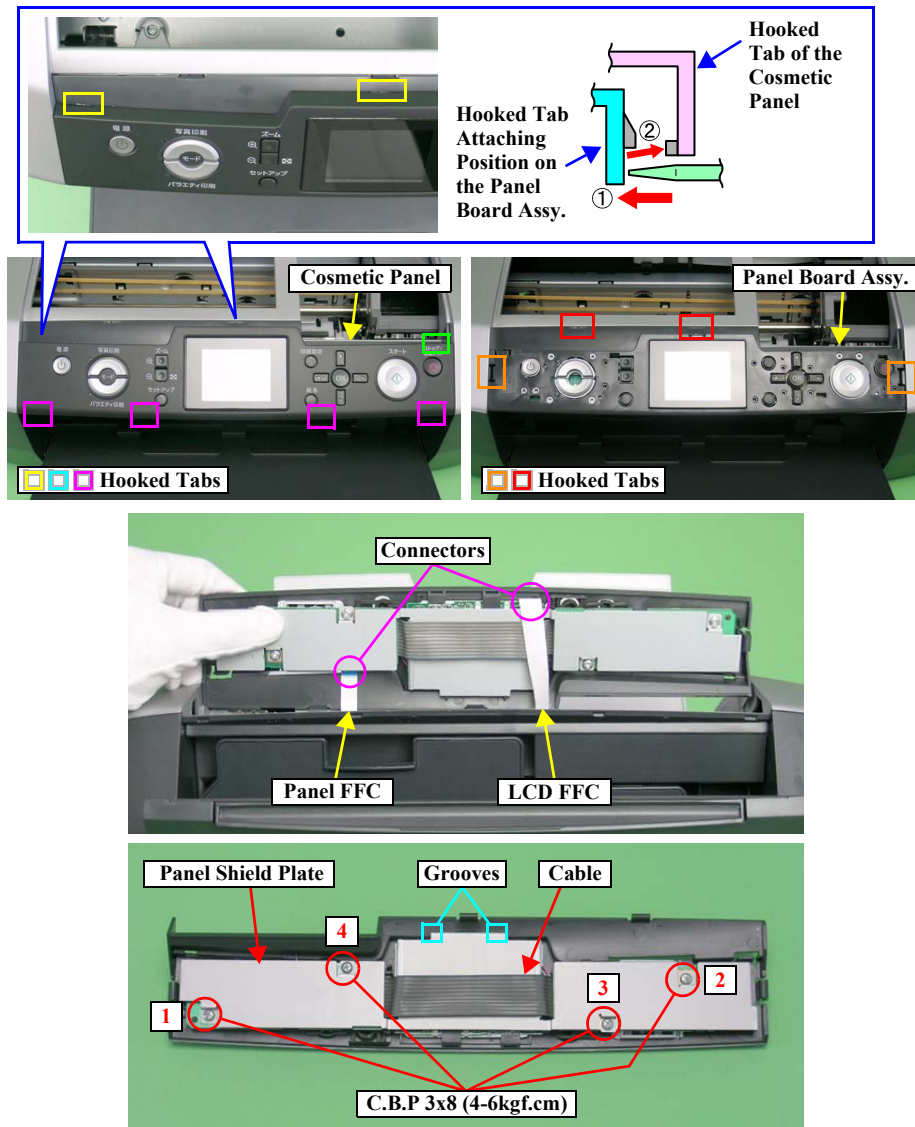

Figure 2-8. Removing the Panel Board/LCD Module (1)

- Parts/Components must be removed to remove the Panel Board/LCD Module.

None

- Disassembly Procedure

1. Open the Printer Cover and Stacker Assy.



When performing the next step to remove the Cosmetic Panel, be careful not to damage the two hooked tabs (□) of the Cosmetic Panel.

2. Push the two hooked tab attaching positions on the Panel Board Assy. with a flat-blade screwdriver to release the two tabs (□) of the Cosmetic Panel and then release the upper right tab (□).
3. Release the lower four tabs (□) that secure the Cosmetic Panel and remove it.



When performing the next step, be careful not to pull the Panel Board Assy. too much as it is still connected to the printer with the FFC and the FFC is secured with two-sided tape.

4. Release the two tabs (□) located at both ends of the Panel Board Assy. with a flat-blade screwdriver and then release the two tabs (□) to remove the Panel Board Assy.
5. Disconnect the Panel FFC and the LCD FFC from the connectors.
6. Remove the four screws (○) that secure the Panel Shield Plate.
7. Release the Panel Shield Plate from the two grooves (□) and remove the panel pulling it out under the cable.

□ Illustration (2)

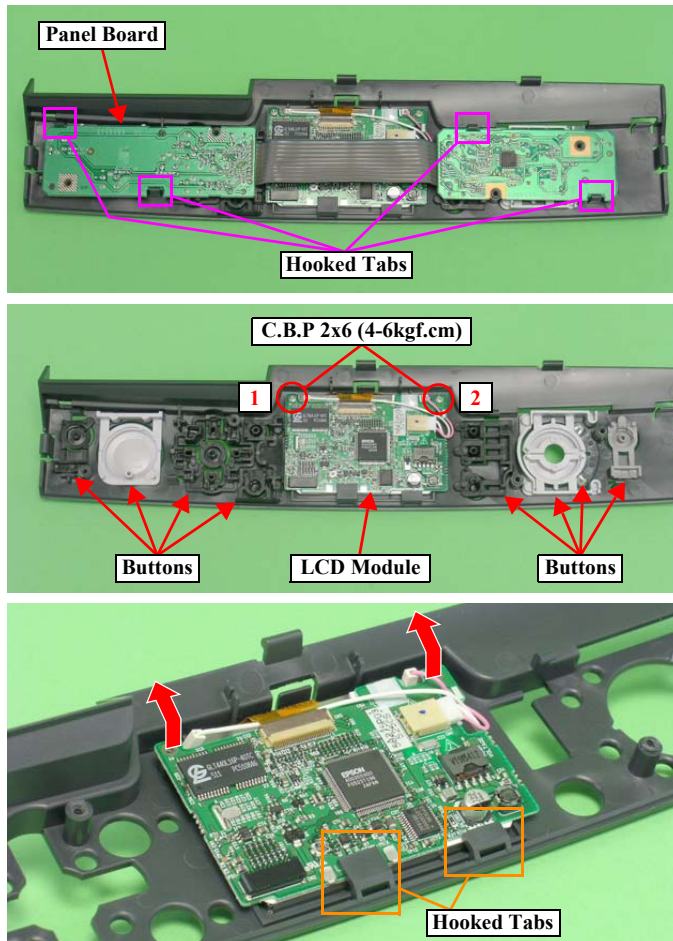

Figure 2-9. Removing the Panel Board/LCD Module (2)

8. Release the four tabs (□) that secure the Panel Board and remove it.
9. Remove the all buttons from the Housing Panel Assy.
10. Remove the two screws (○) that secure the LCD Module.
11. Release the LCD Module from the two tabs (□) by pulling the module toward the opposite direction of the tabs attached side, and remove the LCD Module from the Housing Panel Assy.



- Tighten the screws to secure the LCD Module in the order shown in Figure 2-9.
- Make sure the four positioning holes of the Panel Board are aligned with the two screw holes and put onto the two guide pins.

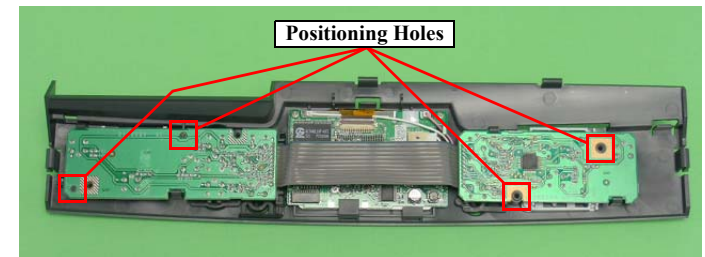

Figure 2-10. Reinstalling the Panel Board

- Tighten the screws to secure the Panel Shield Plate in the order shown in Figure 2-8.
- Make sure that the Cosmetic Panel is properly fitted on the Panel Board Assy.

2.3.5 Removing the Upper Housing

□ Illustration (1)

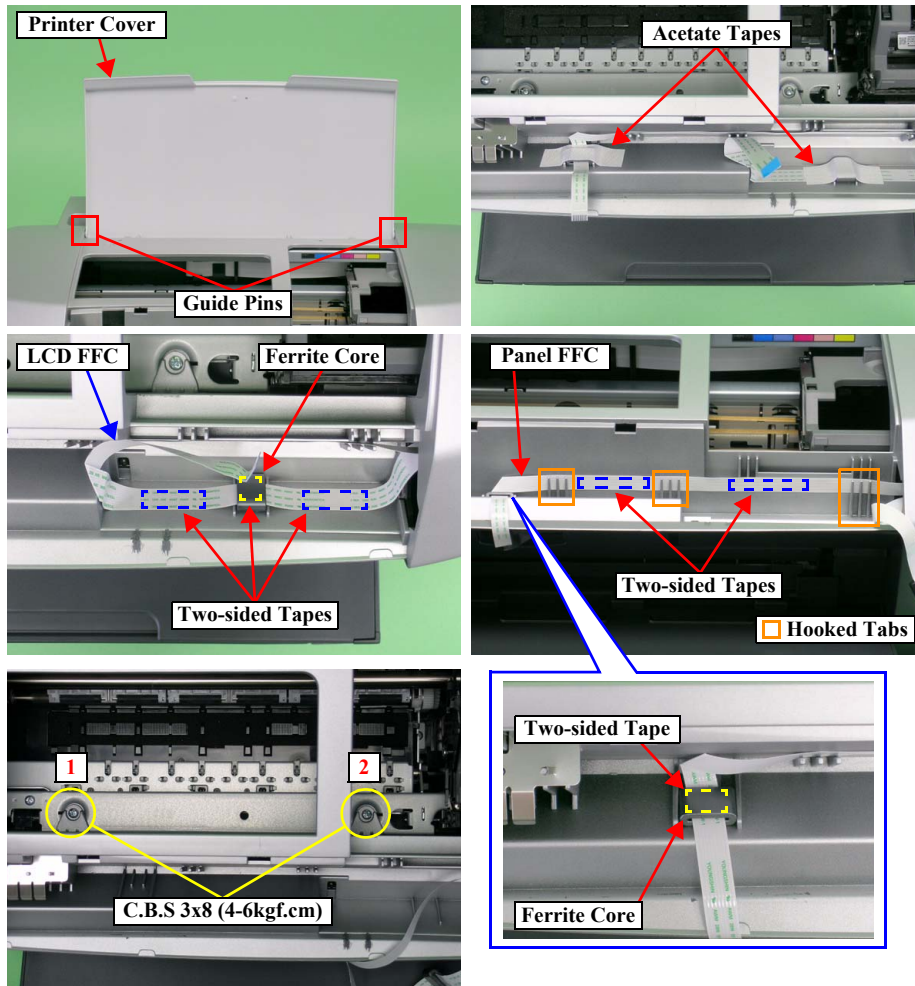

Figure 2-11. Removing the Upper Housing (1)

□ Parts/Components must be removed to remove the Upper Housing.

Paper Support Assy., Left Housing, Right Housing, Panel Board Assy. (Panel Board and LCD Module)

□ Disassembly Procedure

1. Move the Carriage Unit to its home position.
2. Release the two tabs (□) that secure the Printer Cover and remove it.
3. Open the CD-R Guide Assy.
4. Remove the two pieces of acetate tape that secure the two ferrite cores.
5. Remove the three pieces of two-sided tape that secure the LCD FFC and the ferrite core to release the LCD FFC.
6. Remove the three pieces of two-sided tape that secure the Panel FFC and the ferrite core and release the Panel FFC from the three tabs (□).



Before removing the Upper Housing, make sure that the LCD FFC and Panel FFC are completely released. If you remove the Upper Housing with the FFCs secured, they may become deformed by elongation.

7. Remove the two screws (○) that secure the Upper Housing.

□ Illustration (2)

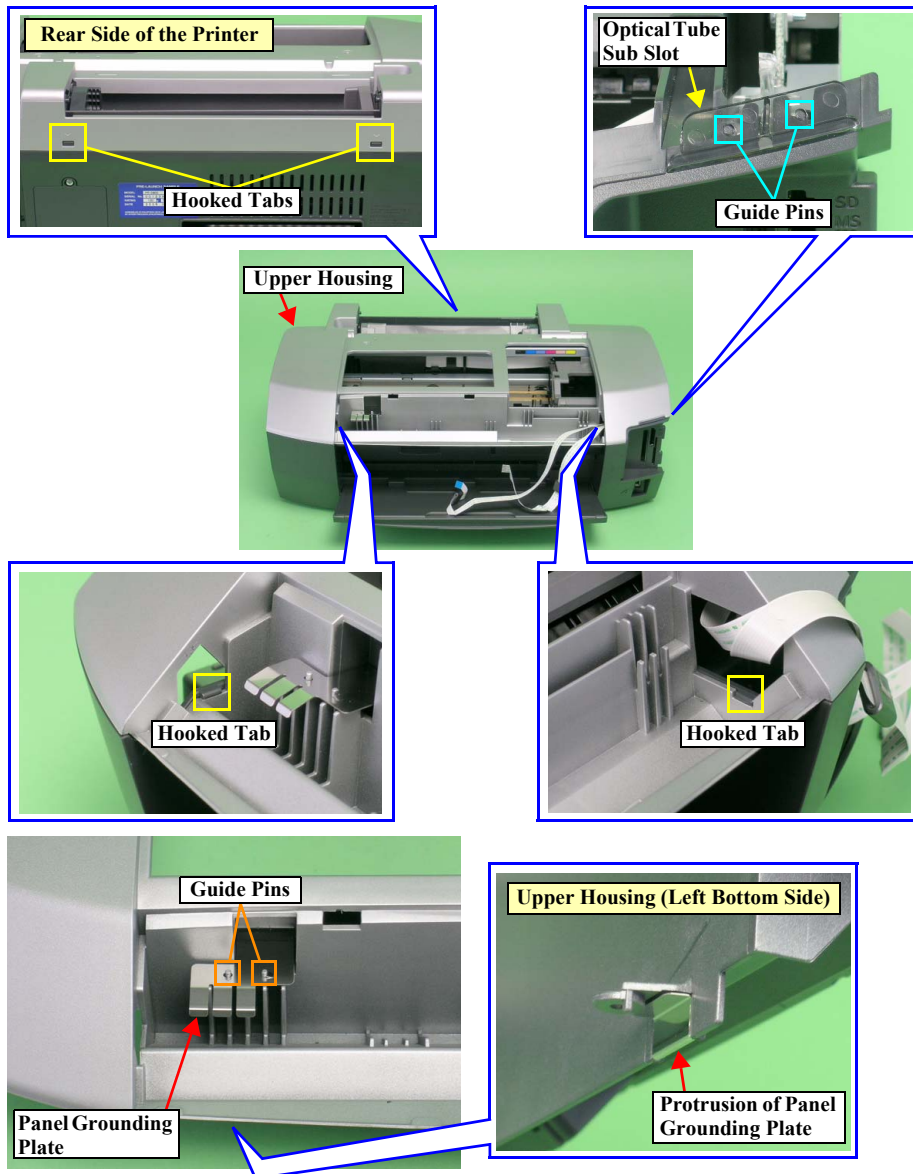

Figure 2-12. Removing the Upper Housing (2)

8. Lift the front right edge of the Upper Housing to release the Optical Tube Sub Slot from the two guide pins (□) on the Housing Slot.
9. Release the four tabs (□) that secure the Upper Housing with a flat-blade screwdriver and lift the Upper Housing to remove it, then disconnect the Panel FFC and the LCD FFC.
10. Release the Panel Grounding Plate from the two guide pins (□) of the Upper Housing.
11. Pull out the protruded lower part of the Panel Grounding Plate from the Upper Housing.



- Tighten the screws to secure the Upper Housing in the order shown in Figure 2-11.
- The ferrite core of the Panel FFC should be located at the position shown in the figure below.

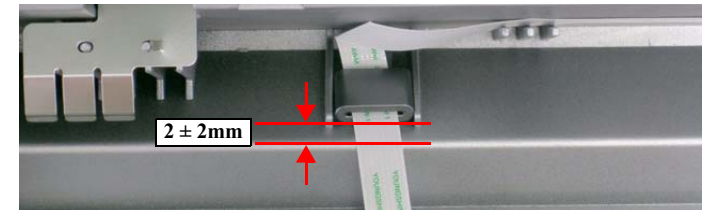

Figure 2-13. Reattaching the Ferrite Core

- The ferrite core of the LCD FFC should be located at the position shown in the figure below.

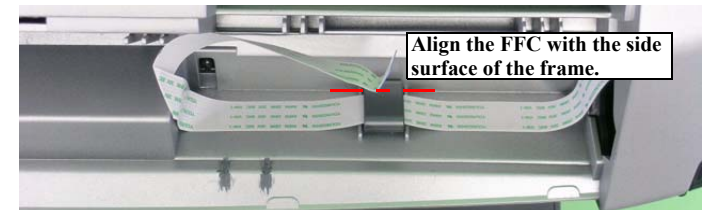

Figure 2-14. Reattaching the Ferrite Core

- Make sure to route the Panel FFC and the LCD FFC as shown in the Figure 2-11.

2.3.6 Removing the Rear Housing

□ Illustration

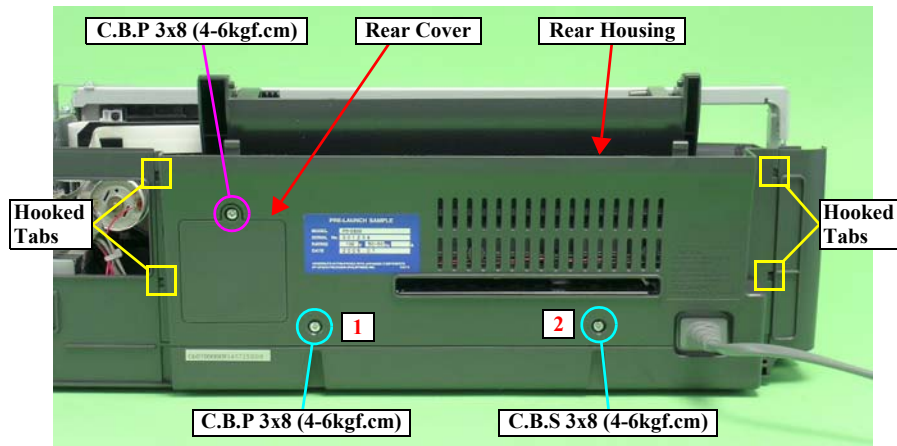

Figure 2-15. Removing the Rear Housing

□ Parts/Components must be removed to remove the Rear Housing.

Paper Support Assy., Left Housing, Right Housing,
Panel Board Assy. (Panel Board and LCD Module), Upper Housing

□ Disassembly Procedure

1. Remove the screw (○) that secures the Rear Cover and remove it.
2. Remove the two screws (○) that secure the Rear Housing.
3. Slightly lift the Rear Housing to release it from the four tabs (□), and remove the Rear Housing.



- Tighten the screws to secure the Rear Housing in the order shown in [Figure 2-15](#).
- Put the two tabs of the Rear Cover into the notches of the frame.

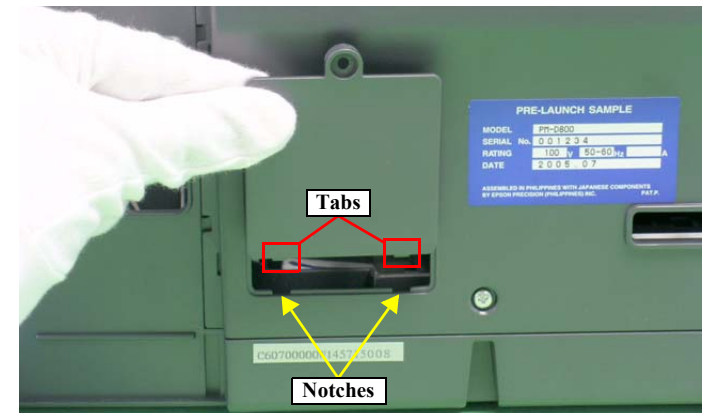

Figure 2-16. Reattaching the Rear Cover

2.3.7 Removing the Stacker Assy.

□ Illustration

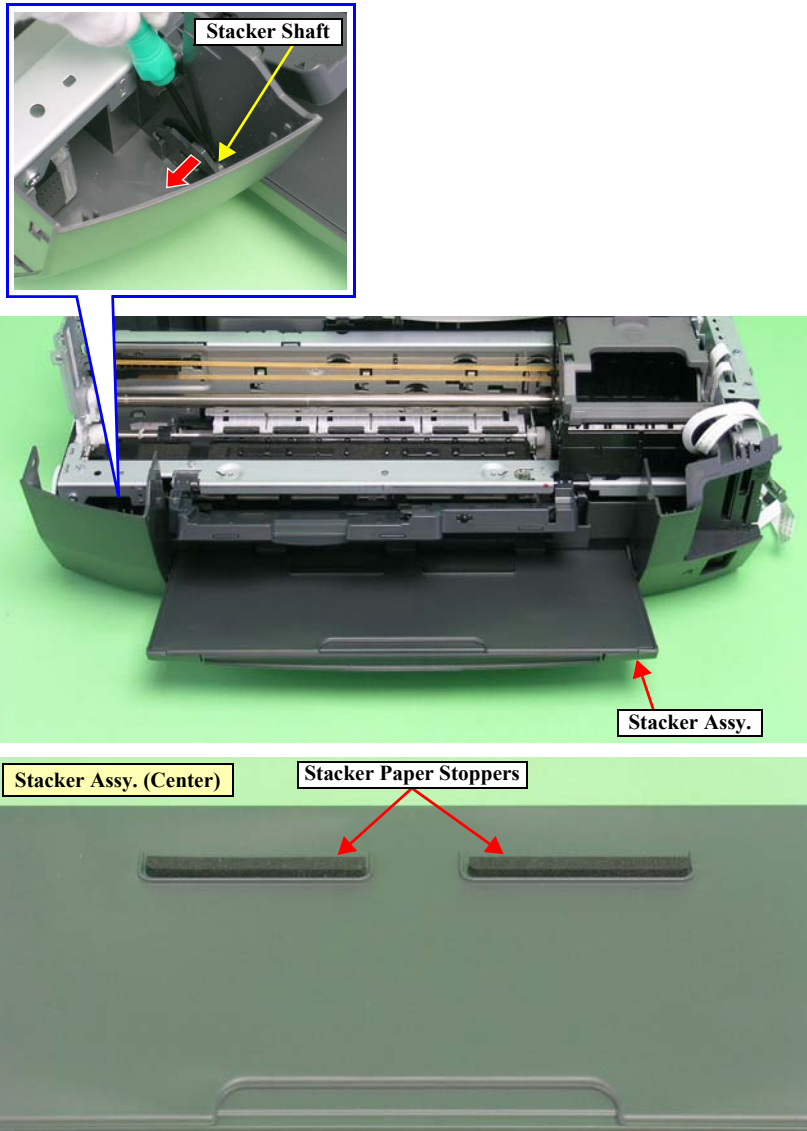

Figure 2-17. Removing the Stacker Assy.

- Parts/Components must be removed to remove the Stacker Assy.
Paper Support Assy., Left Housing, Right Housing,
Panel Board Assy. (Panel Board and LCD Module), Upper Housing

□ Disassembly Procedure

1. Release the shaft of the Stacker Shaft with a flat-blade screwdriver and pull the left side of the Stacker Assy. toward you to remove the assy.



- The two Stacker Paper Stoppers must be securely affixed to the ribs of the Stacker Assy.



Figure 2-18. Reattaching the Stacker Paper Stoppers

- Make sure to put the guide pin of the Stacker Assy. into the positioning hole on the frame.

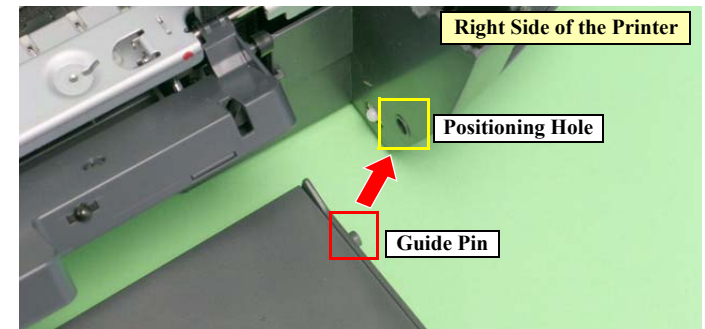

Figure 2-19. Reinstalling the Stacker Assy.

2.3.8 Removing the Front Paper Guide Porous Pads

□ Illustration

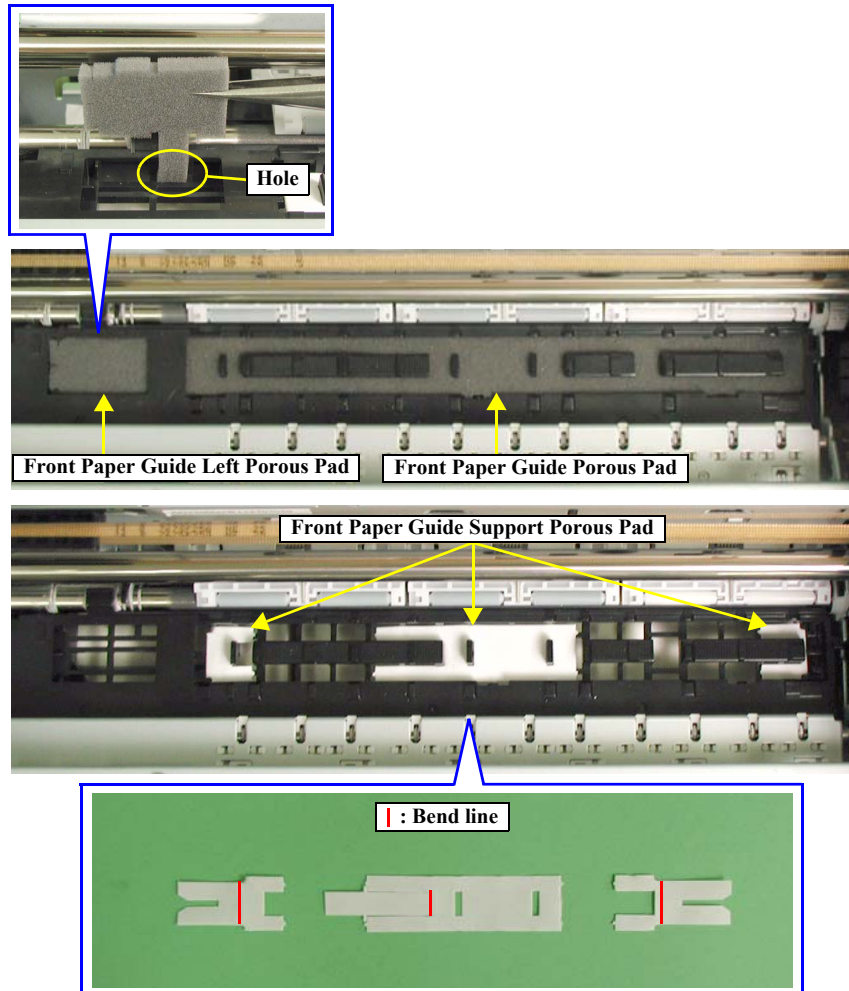

Figure 2-20. Removing the Front Paper Guide Porous Pads

□ Parts/Components must be removed to remove the Front Paper Guide Porous Pad.

Paper Support Assy., Left Housing, Right Housing, Panel Board Assy. (Panel Board and LCD Module), Upper Housing

□ Disassembly Procedure

1. Remove the following three pads from the Front Paper Guide Assy. with tweezers.
 - Front Paper Guide Porous Pad
 - Front Paper Guide Left Porous Pad
 - Front Paper Guide Support Porous Pad

CAUTION



The Front Paper Guide Porous Pads are glued on the Front Paper Guide. Remove the pads carefully not to torn them.



- Reattaching the Front Paper Guide Support Porous Pad
 - Bend the support porous pad along the bend line at a right angle, and attach it to the Front Paper Guide. Make sure to put the bent portion of the pads under the ribs and tightly fit the pads onto the Front Paper Guide.
- Reattaching the Front Paper Guide Porous Pad
 - Apply Three Bond 1401 to the six points on the Front Paper Guide shown in the figure below. Immediately after applying the bond, attach the Front Paper Guide Porous Pad.

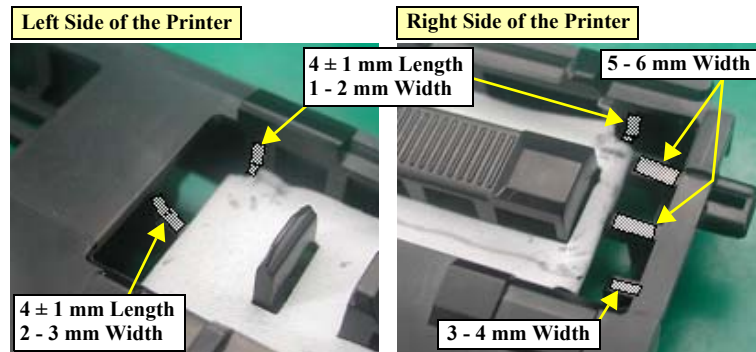

Figure 2-21. Bond Applying Positions and Areas for Front Paper Guide Porous Pad

- After attaching the Front Paper Guide Porous Pad, draw a mark on the left of the Front Paper Guide with a red pen.

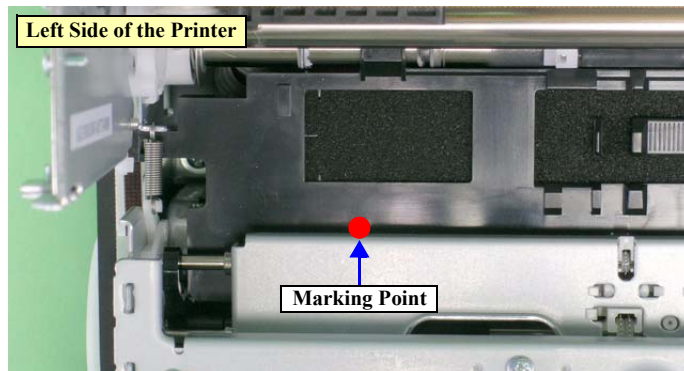

Figure 2-22. Marking Point



- Put the Front Paper Guide Porous Pad under the ribs and be sure that the pad is tightly fitted on the Front Paper Guide. Adjust the position of the Front Paper Guide Porous Pad so that the gap between the pad and the Front Paper Guide is 0.5 to 1.0 mm.

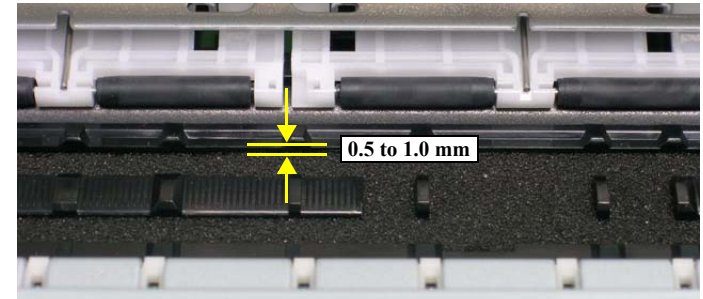

Figure 2-23. Reattaching the Front Paper Guide Porous Pad

- Reattaching the Front Paper Guide Left Porous Pad
 - Put the protrusion of the Front Paper Guide Left Porous Pad into the hole shown in Figure 2-20, and make sure the pad is tightly fitted on the Front Paper Guide.



- Be careful not to damage the Front Paper Guide Support Porous Pads.
- Be careful not to apply too much bond. Do not contaminate the Front Paper Guide Support Porous Pads with the bond.
- The porous pad surface must be lower than the surface of the Front Paper Guide by 0.5 to 1 mm.

2.3.9 Removing the Main Board Assy.

□ Illustration (1)

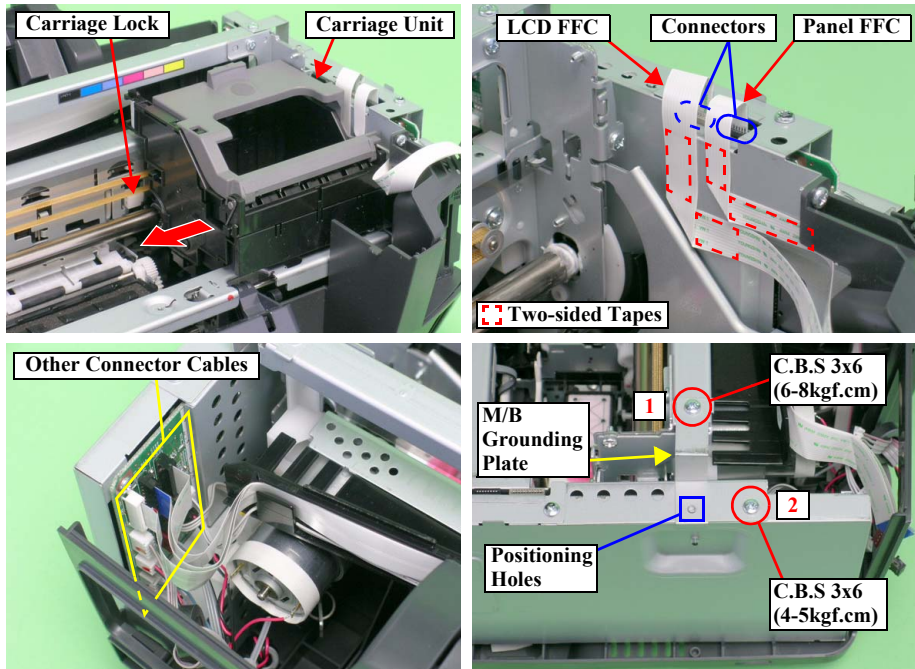

Figure 2-24. Removing the Main Board Assy. (1)

□ Parts/Components must be removed to remove the Main Board Assy.

Paper Support Assy., Left Housing, Right Housing,
Panel Board Assy. (Panel Board and LCD Module), Upper Housing

□ Disassembly Procedure

1. Unlock the carriage lock with tweezers and move the Carriage Unit to the center.
2. Remove the two pieces of two-sided tape that secure the Panel FFC and LCD FFC and disconnect the FFCs from the Main Board Assy.
3. Disconnect the other connector cables from the Main Board Assy.
4. Remove the two screws (○) that secure the M/B Grounding Plate and remove it.

□ Illustration (2)

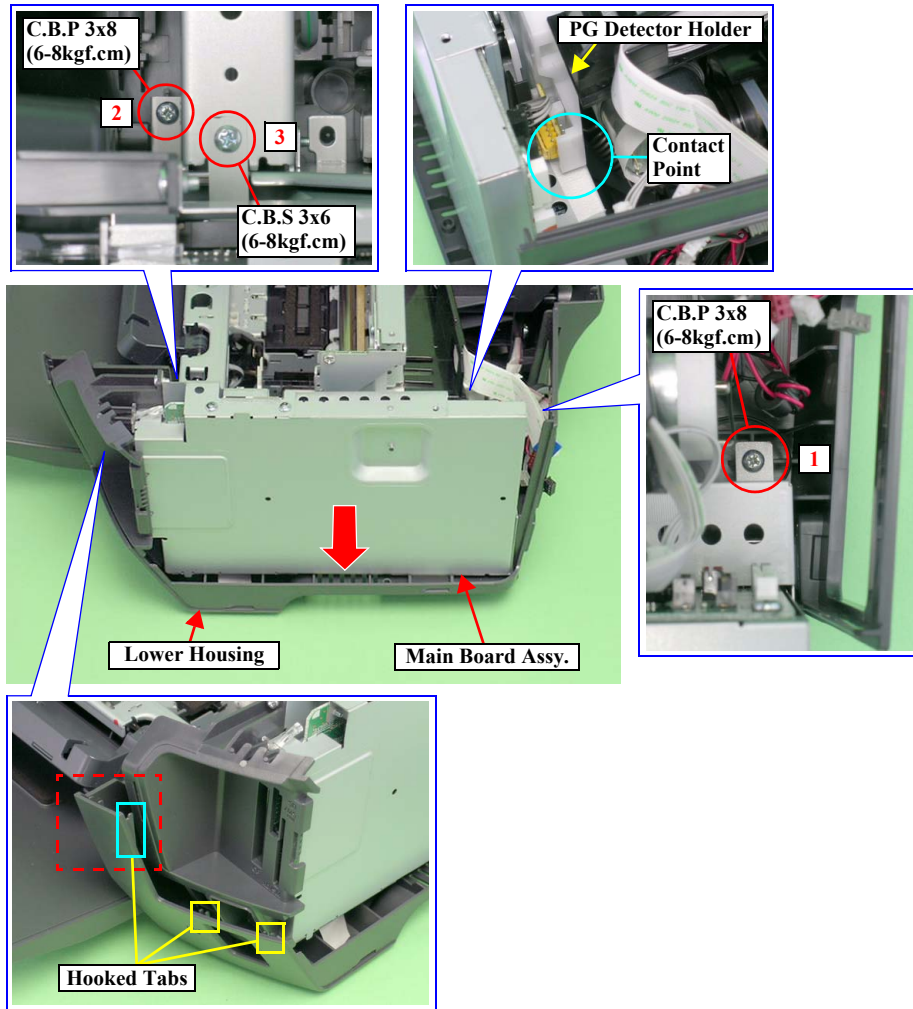

Figure 2-25. Removing the Main Board Assy. (2)

□ Illustration (3)

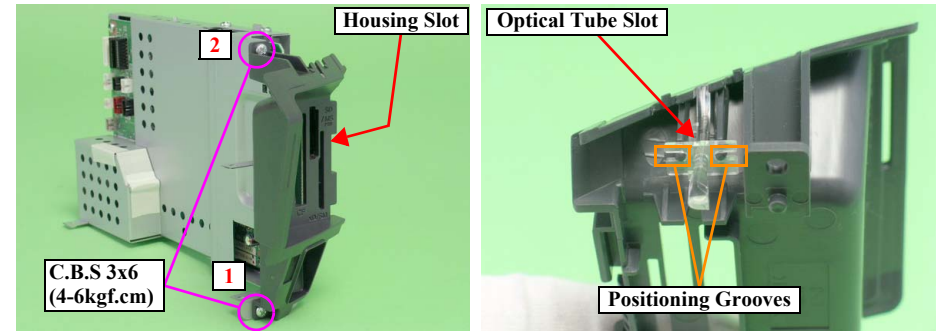

Figure 2-26. Removing the Main Board Assy. (3)

5. Remove the three screws (○) that secure the Main Board Assy.
6. Pull the right side of the Lower Housing (▣) toward you, and lift the front side of the Main Board Assy. to release it from the hooked tab (□) and the other two tabs (□). Then remove the Main Board Assy. rightward avoiding a contact with the PG Detection Holder.
7. Remove the two screws (○) that secure the Housing Slot and remove it.
8. Remove the Optical Tube Slot from the Housing Slot.



- Set the two positioning grooves (□) of the Optical Tube Slot onto the two guide pins. See Figure 2-26.
- Set the two guide pins (□) of the Housing Slot into the positioning holes.

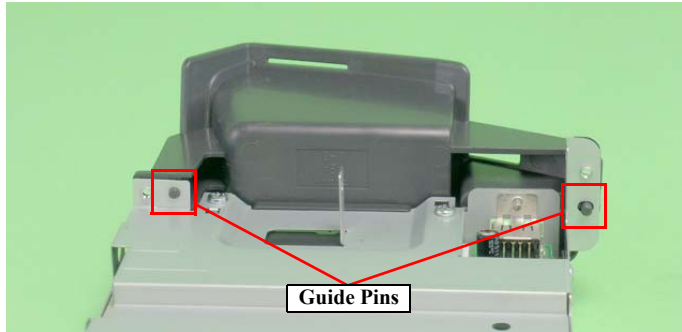

Figure 2-27. Reinstalling the Housing Slot

- Tighten the screws to secure the Housing Slot in the order shown in Figure 2-26.
- Make sure that the connector cable of the Tray/CD-R Sensor is routed as shown in the figure below before placing the Main Board Assy.

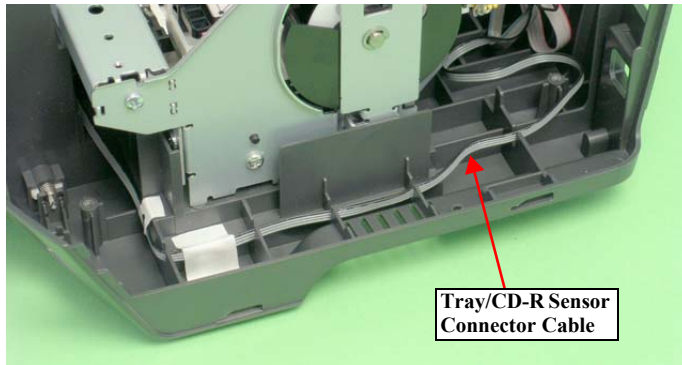

Figure 2-28. Routing the Connector Cable



- Tighten the screws to secure the Main Board Assy. in the order shown in Figure 2-25.
- Make sure there is no gap between the Housing Slot and the Lower Housing.

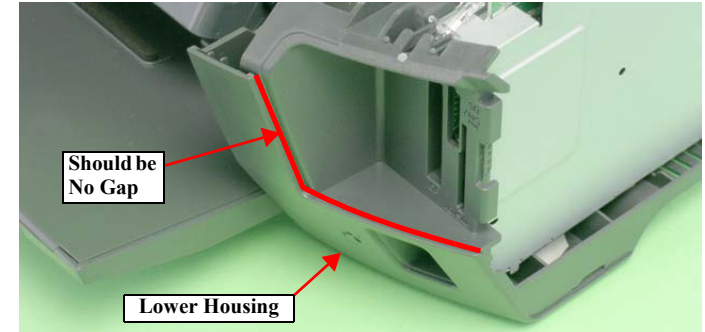

Figure 2-29. Reinstalling the Main Board Assy.

- Set the positioning hole (□) of the M/B Grounding Plate onto the guide pin. See Figure 2-24.
- Tighten the screws to secure the M/B Grounding Plate in the order shown in Figure 2-24.
- Connect the connector cables to the Main Board Assy. in the order given in the table below.

Order	Connector No.	Color	Number of Pins	Destination
1	CN11	Black	4	CR Motor
2	CN4	White	3	PE Sensor
3	CN2	Red	4	Tray/CD-R Sensor
4	CN3	Black	3	PG Sensor
5	CN1	Gray	3	Power Supply Board
6	CN12	White	2	PG Motor
7	CN10	White	4	PF Motor
8	CN8	Black	15	Head Cable
9	CN7	Black	14	Head Cable
10	CN9	White	14	Head Cable

REASSEMBLY

- Align the Panel FFC and the LCD FFC with the lines marked on the side of the Main Board Assy., and secure them with two-sided tape keeping the positions shown in the figure below.

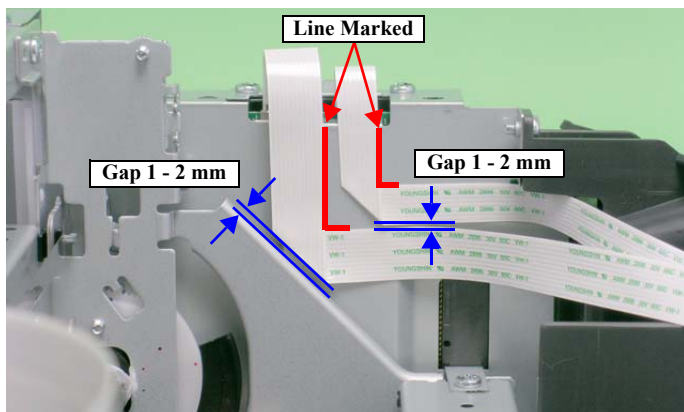

Figure 2-30. Routing the Panel FFC

**ADJUSTMENT
REQUIRED**

Whenever the Main Board Assy. is replaced, be sure to perform the required adjustments in the order given below. (See Chapter 3 for details on the adjustments)

- When retrieving the ID data from the previous main board is possible
 - EEPROM data copy
- When the ID data cannot be read out from the previous main board
 - Replace the Waste Ink Pad with a new one (Because the waste ink counter information cannot be retrieved.)
 - Market setting
 - USB ID input
 - Protection counter
 - Head Rank ID Label input
 - First Dot adjustment
 - PW Sensor adjustment
 - Head Angle adjustment
 - Bi-D Adjustment
 - Offset Input for CR Motor Calorific Limitation

2.3.10 Removing the ASF Assy.

□ Illustration

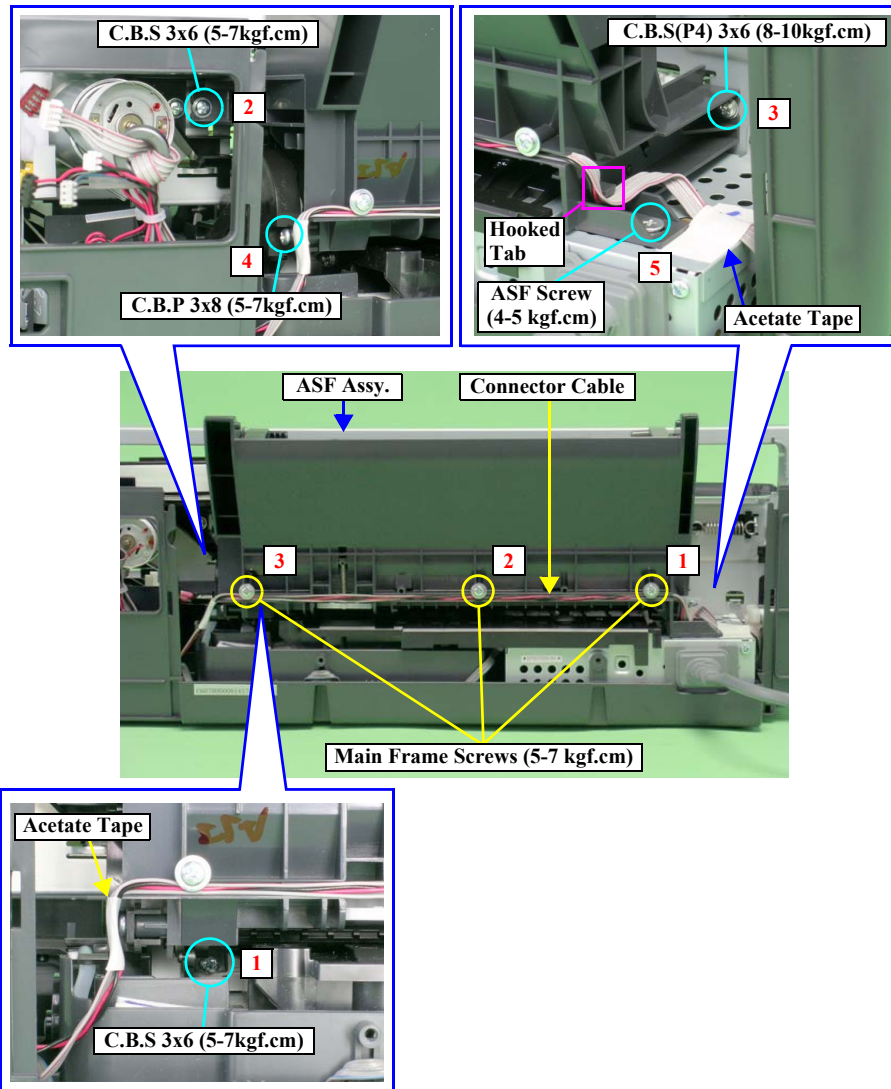

Figure 2-31. Removing the ASF Assy.

□ Parts/Components must be removed to remove the ASF Assy.

Paper Support Assy., Left Housing, Right Housing, Panel Board Assy. (Panel Board and LCD Module), Upper Housing, Rear Housing, Main Board Assy.

□ Disassembly Procedure

1. Remove the three Main Frame Screws (○) that secure the connector cables of the PF Motor and the PG Motor, and release the cables from the groove.
2. Remove the two pieces of acetate tape that secures the connector cables of the PF Motor and the PG Motor and release the cables from the hooked tab (□) of the ASF Assy.
3. Remove the five screws (○) that secure the ASF Assy., and remove it toward the rear of the printer.

□ Illustration

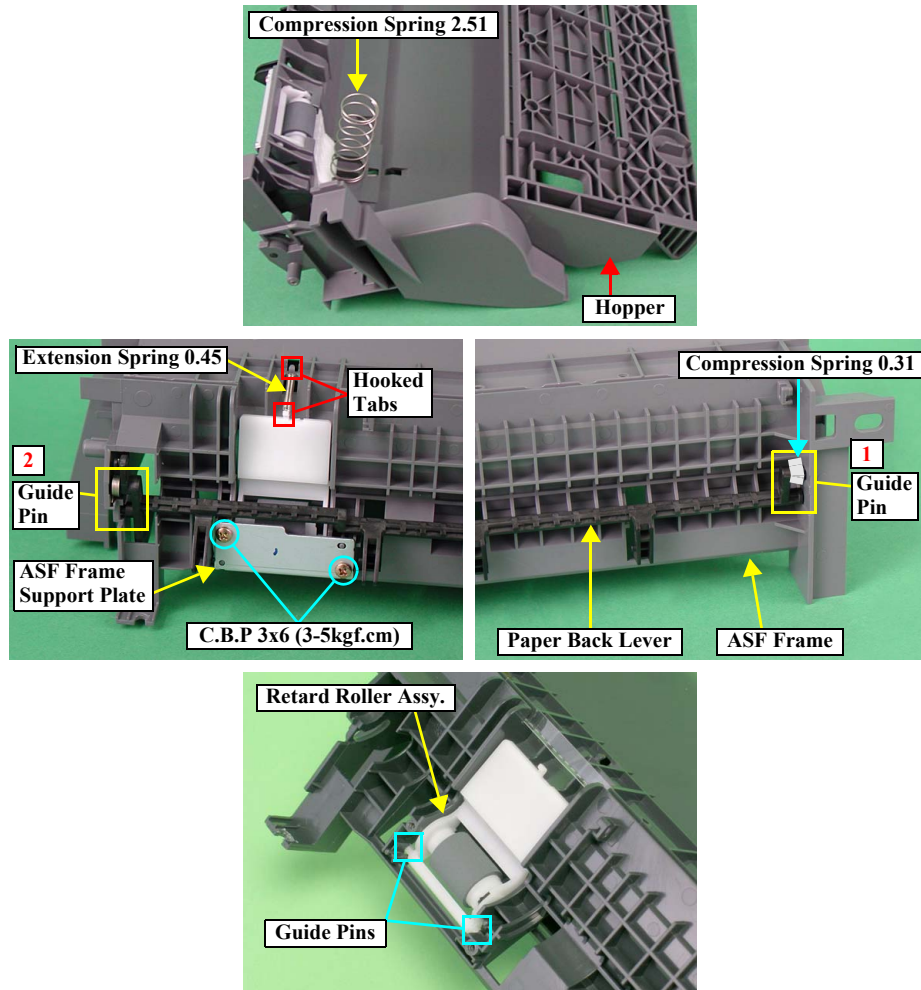

Figure 2-32. Removing the ASF Assy. (2)



When performing the next step, be careful not to touch the Hopper Pad with bare hands.

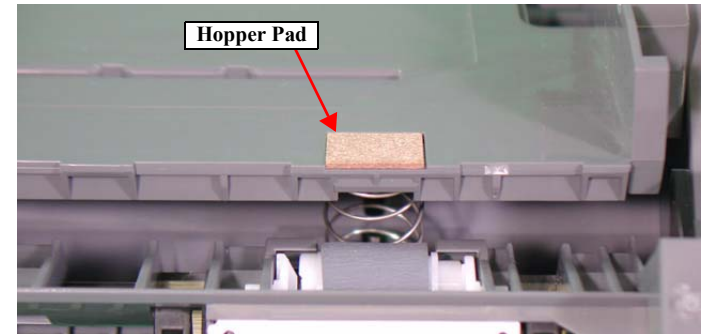

Figure 2-33. Handling the Hopper Pad

4. Open the Hopper and remove the Compression Spring 2.51.



When performing the next step, be careful not to lose the Compression Spring 0.31.

5. Bow the Paper Back Lever to release the both ends of it from the two guide pins (□) in the order of 1 and 2, and remove the Paper Back Lever together with the Compression Spring 0.31.
6. Remove the two screws (●) that secure the ASF Frame Support Plate and remove it.
7. Release the Extension Spring 0.45 from the two tabs (□) and remove the spring.
8. Open the Retard Roller Assy. and release it from the two guide pins (□) and remove the Retard Roller Assy.



■ Reassembling the ASF Assy.

- Hitch the L-shaped leg of the Torsion Spring 6.45 to the shaft of the Paper Back Lever, and hitch the other shorter leg of the spring to the groove of the ASF Assy.

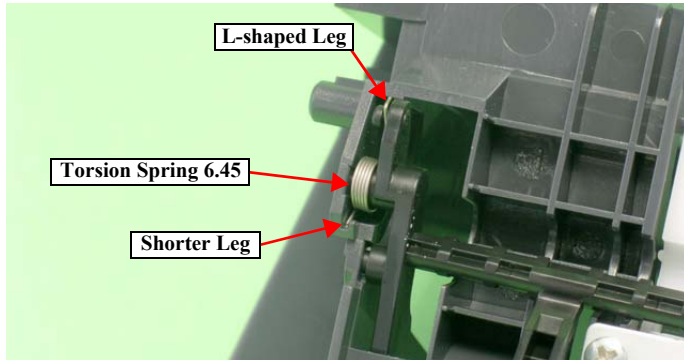

Figure 2-34. Reattaching the Torsion Spring 6.45

- Make sure that the Paper Back Lever and the Retard Roller Assy. move smoothly.
- Tighten the screws to secure the ASF Frame Support Plate in the order shown in the figure below.



Figure 2-35. Reinstalling the ASF Frame Support Plate



■ Reinstalling the ASF Assy.

- Attach the Compression Spring 2.51 to the rib (□) of the Hopper and the two ribs (□) of the ASF Frame, and make sure that the Hopper moves smoothly.

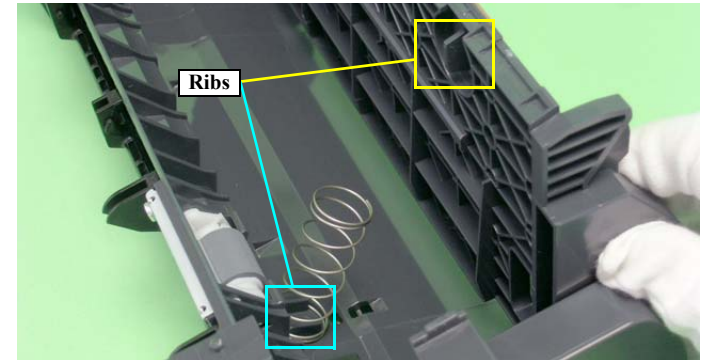

Figure 2-36. Reinstalling the Hopper

- Set the guide pin (□) of the ASF Assy. and the rib (□) in the positioning holes.

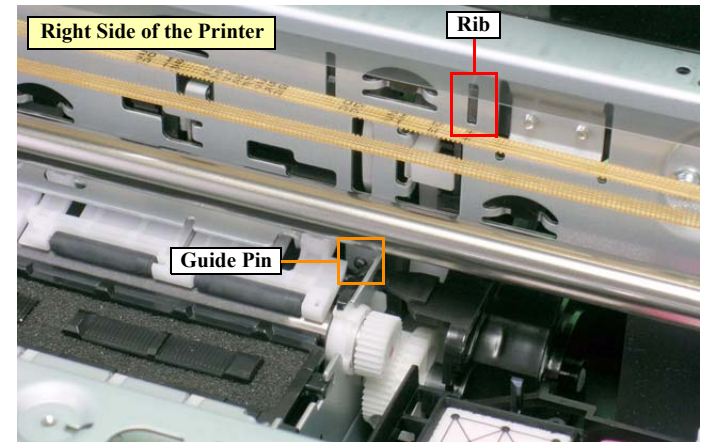

Figure 2-37. Reinstalling the ASF Assy. (1)



- Set the positioning groove of the ASF Assy. onto the guide pin.

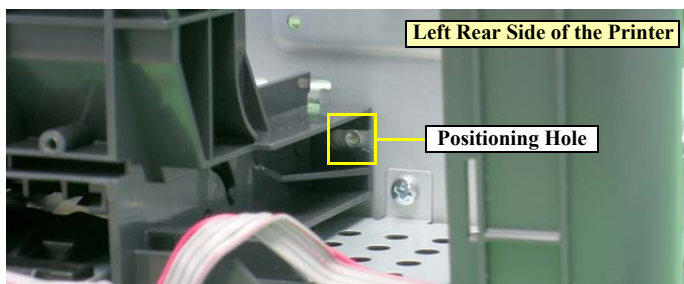

Figure 2-38. Reinstalling the ASF Assy. (2)

- Hold down the left upper side of the ASF Assy. (when viewed from the rear of the printer) while screwing the assy. in the order shown in Figure 2-31. Do not hold down the center of the ASF Assy.
- Make sure that there is no gap between the ASF Assy., Main Frame and Power Supply Assy.

■ Routing and Securing the Connector Cables of the PF Motor and PG Motor

- Set the connector cables of the PF Motor and the PG Motor into the groove of the ASF Assy. as shown in the figure below.

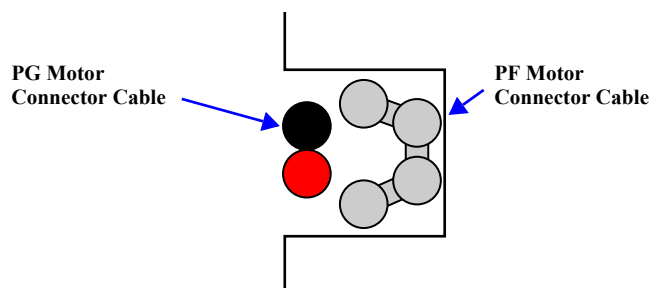

Figure 2-39. Setting the PF Motor and PG Motor Connector Cables (Section View of the Groove)



- Tighten the screws in the order shown in Figure 2-31, so as not to trap the PF Motor and PG Motor connector cables under the ASF Assy.
- Tie the cables by wrapping acetate tape around them at the position shown in the figure below.

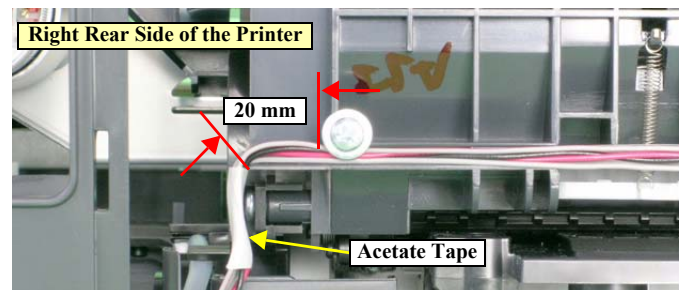

Figure 2-40. Tying the Connector Cables with Acetate Tape

- Be sure that the PF Motor and PG Motor connector cables do not contact with the shaft edge of the Paper Back Lever.

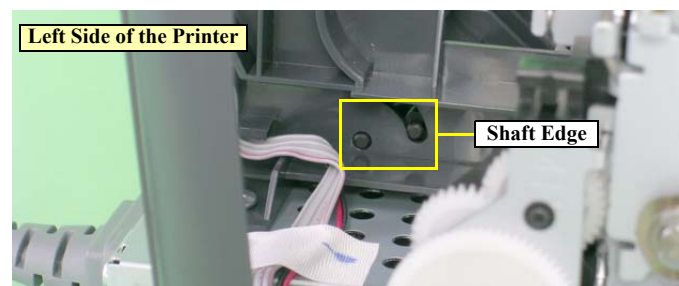

Figure 2-41. Setting and Routing the PF Motor and PG Motor Connector Cables



- Whenever the ASF Assy. is replaced, be sure to apply proper amount of the G-74 oil to the specified points. (See Chapter 4 for details on the lubrication)
- Whenever the ASF Assy. is replaced, be sure to perform the required adjustments in the order given below. (See Chapter 3 for details on the adjustments)
 - First Dot adjustment

2.3.11 Removing the Shaft Assy. Holder

□ Illustration

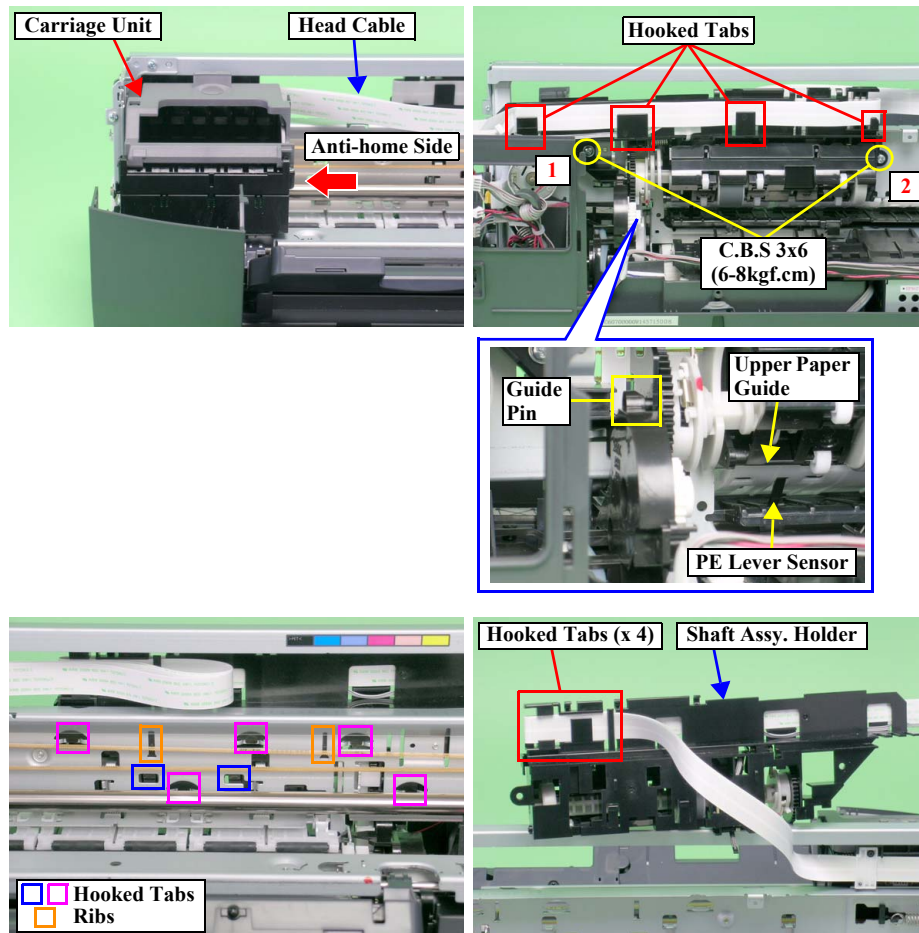

Figure 2-42. Removing the Shaft Assy. Holder (1)

□ Parts/Components must be removed to remove the Shaft Assy. Holder.

Paper Support Assy., Left Housing, Right Housing, Panel Board Assy. (Panel Board and LCD Module), Upper Housing, Rear Housing, Main Board Assy., ASF Assy.

□ Disassembly Procedure

1. Move the Carriage Unit to the anti-home side.
2. Remove the two screws (○) that secure the Shaft Assy. Holder.
3. Release the two tabs (□) that secure the Shaft Assy. Holder upward with tweezers and pull out the guide pin (□) from the Ink System Frame.



When performing the next step, be careful not to damage the PE Sensor Lever as it comes into contact with the Upper Paper Guide.

4. Press down the left side of the Upper Paper Guide (when viewed from the rear of the printer) to release the PE Sensor Lever from the notch, and then slide the Shaft Assy. Holder rightward to remove the assy. toward you.



When performing the next step, be careful not to damage the Head Cable.

5. Release the Head Cable from the eight tabs (□) of the Shaft Assy. Holder.

□ Illustration (2)

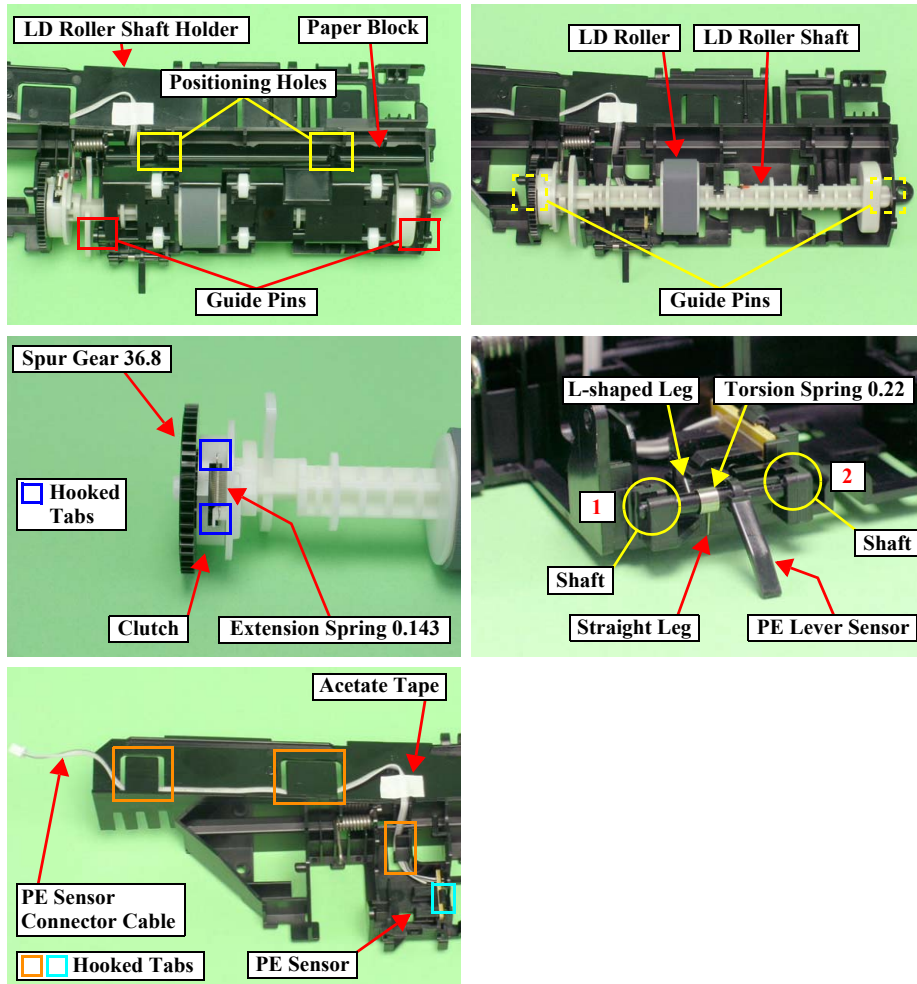

Figure 2-43. Removing the Shaft Assy. Holder (2)

■ Removing the LD Roller Shaft

6. Release the two tabs (□) that secure the Paper Block and remove it.
7. Release the two tabs (⊕) that secure the LD Roller Shaft and remove it together with the Clutch.



When performing the next step, do not touch the LD Roller with bare hands.

8. Remove the Spur Gear 36.8 from the LD Roller Shaft.
9. Release the Extension Spring 0.143 from the tabs (□) of the Clutch and the LD Roller Shaft and remove the spring together with the Clutch.
10. Remove the LD Roller from the LD Roller Shaft.

■ Removing the PE Sensor

11. Remove the shaft of the PE Sensor Lever from the LD Roller Shaft Holder in the order shown in Figure 2-43, and remove the PE Sensor Lever and the Torsion Spring 0.22.
12. Remove the acetate tape that secures the PE Sensor connector cable, and release the cable from the three tabs (□) of the LD Roller Shaft Holder.
13. Release the PE Sensor from the tab (□) and remove the sensor.



■ Reinstalling the PE Sensor

- Route the PE Sensor connector cable as shown in [Figure 2-43](#). Be sure to route the cable under the two ribs of the LD Roller Shaft Holder.

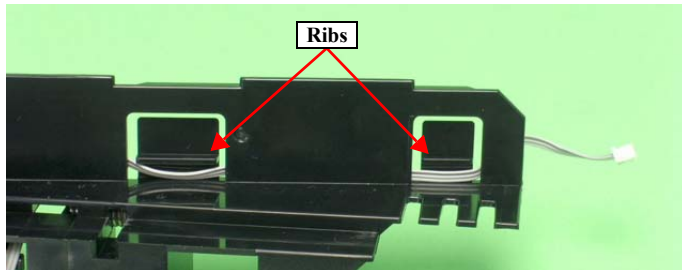

Figure 2-44. Routing the PE Sensor Connector Cable

- Hitch the L-shaped leg of the Torsion Spring 0.22 to the groove of the PE Sensor Lever, and hitch the other straight leg to the LD Roller Shaft Holder.
- Make sure that the PE Sensor Lever moves smoothly.

■ Reinstalling the LD Roller

- Make sure to match the directions of the triangular arrows marked on the LD Roller Shaft and the backside of the LD Roller.

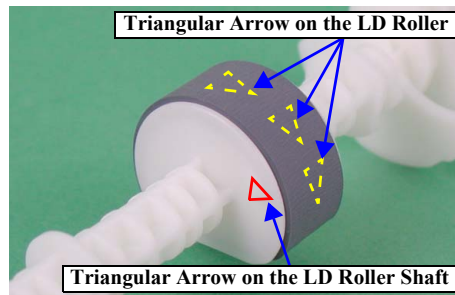

Figure 2-45. Reinstalling the LD Roller



■ Reinstalling the Clutch

- Attach the Extension Spring 0.143 to the Clutch in the correct orientation as shown in the figure below.

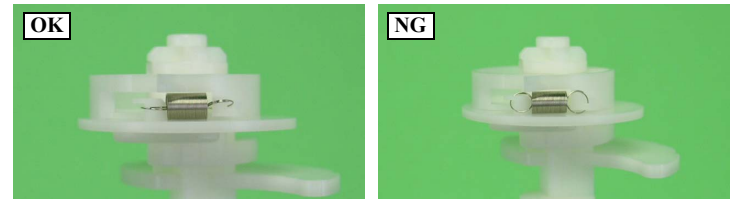

Figure 2-46. Reattaching the Extension Spring 0.143

- Set the positioning hole of the Clutch onto the guide pin.

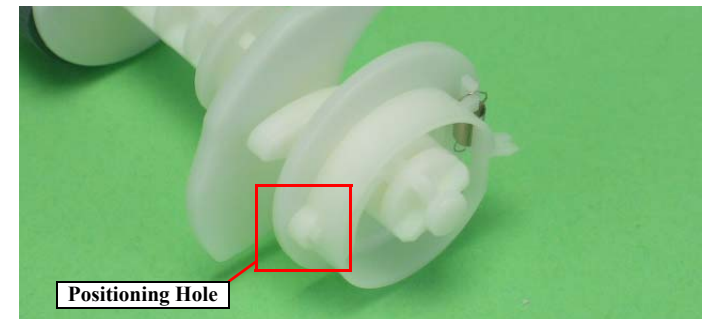

Figure 2-47. Reinstalling the Clutch

- Make sure that the Clutch mechanism moves smoothly.
- Reinstalling the Paper Block
- Set the two positioning holes of the Paper Block onto the shaft. See [Figure 2-43](#).

REASSEMBLY



■ Reinstalling the LD Roller Shaft

- Put the leg of the Torsion Spring 137.7 onto the cam of the LD Roller Shaft to hold down the cam by the spring.

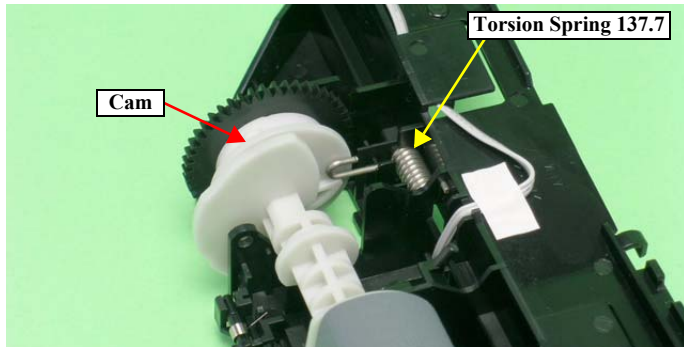

Figure 2-48. Setting the Torsion Spring 137.7

■ Reinstalling the Shaft Assy. Holder

- Press down the left side of the Upper Paper Guide (when viewed from the rear of the printer) to insert the PE Sensor Lever into the notch. Be careful not to damage the PE Sensor Lever. See [Figure 2-42](#).
- Engage the Spur Gear 36.8 and the Combination Gear 27.2,19.2.

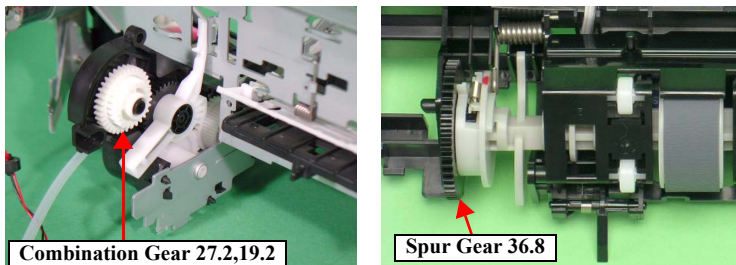

Figure 2-49. Spur Gear 36.8 and Combination Gear 27.2,19.2

- Set the ribs (□) and tabs (□) of the Shaft Assy. Holder into the positioning holes of the Main Frame. See [Figure 2-42](#).
- Tighten the screws to secure the Shaft Assy. Holder in the order shown in [Figure 2-42](#).

ADJUSTMENT
REQUIRED

Whenever the LD Roller Shaft is replaced, be sure to apply proper amount of the G-74 oil to the specified points. (See Chapter 4 for details on the lubrication)

2.3.13 Removing the Print Head

□ Illustration

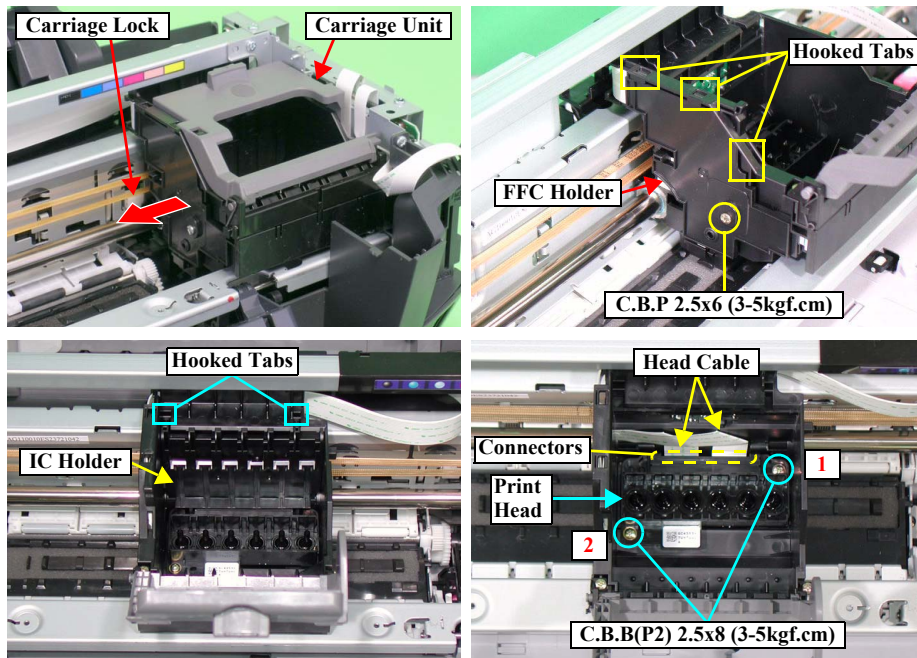

Figure 2-51. Removing the Print Head

□ Parts/Components must be removed to remove the Print Head.

Paper Support Assy., Left Housing, Right Housing,
Panel Board Assy. (Panel Board and LCD Module), Upper Housing

□ Disassembly Procedure

1. Remove the all Ink Cartridges from the Carriage Unit.
2. Unlock the carriage lock with tweezers and move the Carriage Unit to the center.
3. Remove the screw (●) that secures the FFC Holder with a No.1 screwdriver.
4. Slightly bow the bottom of the FFC Holder and slide the holder downward to release it from the three tabs (□) and remove the FFC Holder.
5. Release the IC Holder from the two tabs (□) and remove it upward.
6. Remove the two screws (●) that secure the Print Head with a No.1 screwdriver.
7. Slightly lift the Print Head to disconnect the Head Cable from the Print Head and remove the Print Head.

CAUTION



When handling the Print Head, be sure not to touch and damage the nozzle surface of the Print Head.

REASSEMBLY

- Make sure that the Head Cable is correctly connected to the Print Head.
- Set the two positioning holes (□) of the Print Head onto the two guide pins.

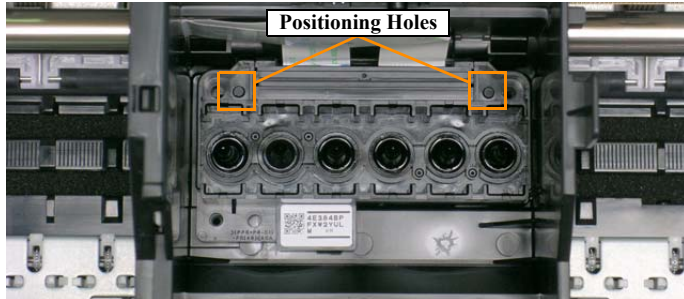

Figure 2-52. Reinstalling the Print Head

- Tighten the screws to secure the Print Head in the order shown in [Figure 2-51](#).

**ADJUSTMENT
REQUIRED**

Whenever the Print Head is reinstalled or replaced, be sure to perform the required adjustments in the order given below. (See Chapter 3 for details on the adjustments)

1. Initial Ink Charge (only when the Print Head is replaced)
2. Head ID input (only when the Print Head is replaced)
3. First Dot adjustment
4. PW Sensor adjustment
5. Head Angle adjustment
6. Bi-D Adjustment

2.3.14 Removing the Upper Paper Guide

□ Illustration

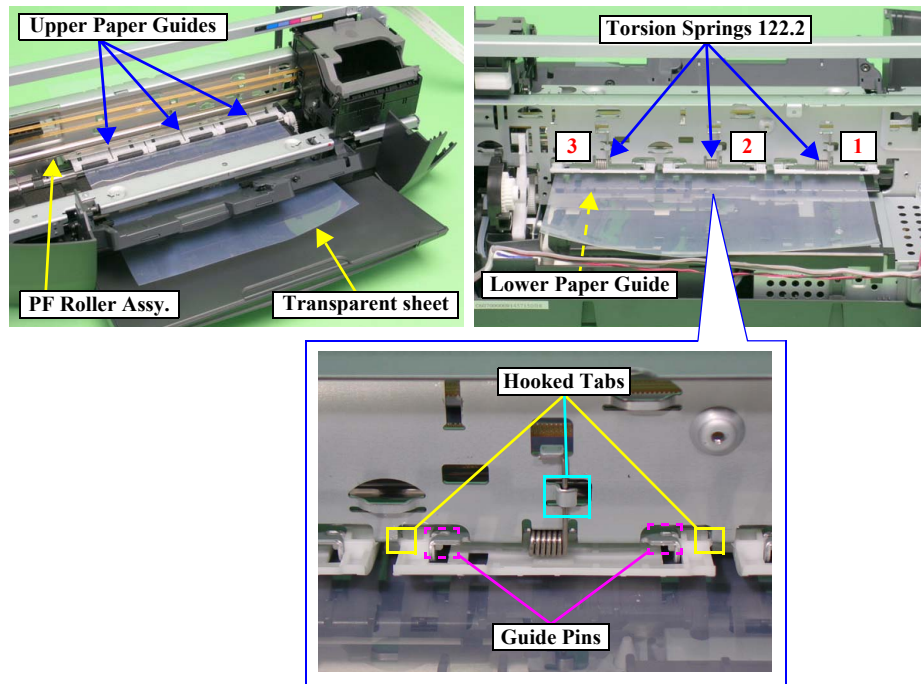

Figure 2-53. Removing the Upper Paper Guide

□ Parts/Components must be removed to remove the Upper Paper Guide.

Paper Support Assy., Left Housing, Right Housing, Panel Board Assy. (Panel Board and LCD Module), Upper Housing, Rear Housing, Main Board Assy., ASF Assy., Shaft Assy. Holder

□ Disassembly Procedure

1. Move the Carriage Unit to the home position.
2. Put a transparent sheet on the Upper Paper Guide and the PF Roller Assy.
3. Release the three Torsion Springs 122.2 from the tabs (□) of the Main Frame and remove the springs toward you.
4. Release the six tabs (□) that secure the three Upper Paper Guides (two tabs for each), and slightly lift the guides to pull out the guide pins (□).
5. While pressing down the Lower Paper Guide, pull out the six tabs (□) released at Step 4 toward you, and pull out the three Upper Paper Guides.



■ Put the leg of the Torsion Springs 122.2 into the groove of the Upper Paper Guide.

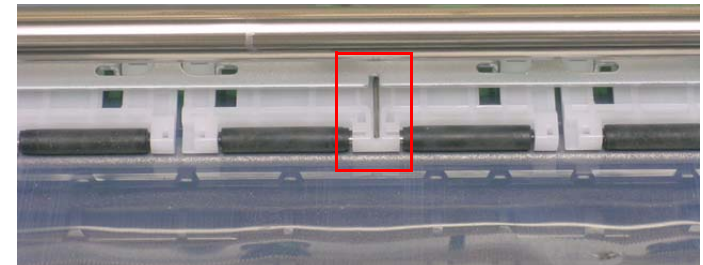

Figure 2-54. Reattaching the Torsion Springs 122.2

■ Attach the Upper Paper Guide in the order shown in [Figure 2-53](#).

2.3.15 Removing the Printer Mechanism

□ Illustration (1)

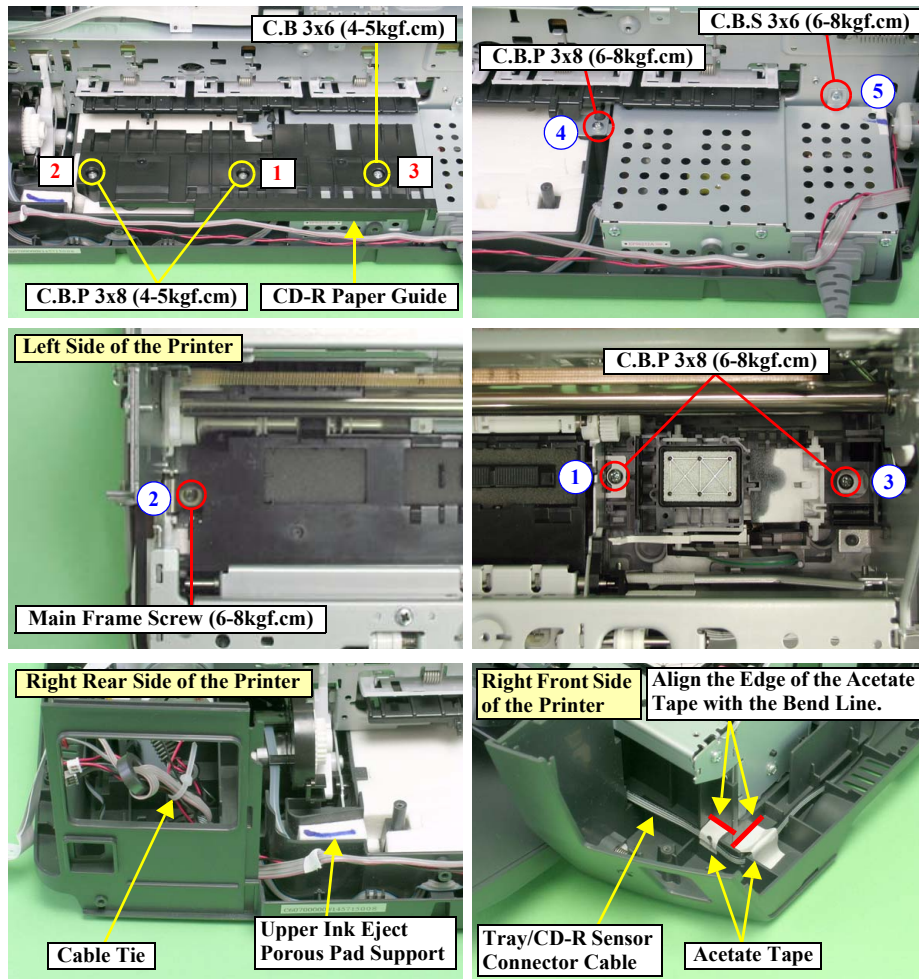

Figure 2-55. Removing the Printer Mechanism (1)

□ Parts/Components must be removed to remove the Printer Mechanism.

Paper Support Assy., Left Housing, Right Housing, Panel Board Assy. (Panel Board and LCD Module), Upper Housing, Rear Housing, Main Board Assy., ASF Assy., Shaft Assy. Holder

□ Disassembly Procedure

1. Move the Carriage Unit to the center.
2. Remove the three screws (○) that secure the CD-R Paper Guide and remove it.
3. Remove the five screws (○) that secure the Printer Mechanism.
4. Cut the cable tie and release the connector cables.
5. Remove the Upper Ink Eject Porous Pad Support from the Lower Housing.
6. Remove the two pieces of acetate tape and release the connector cable of the Tray/CD-R Sensor.

□ Illustration (2)

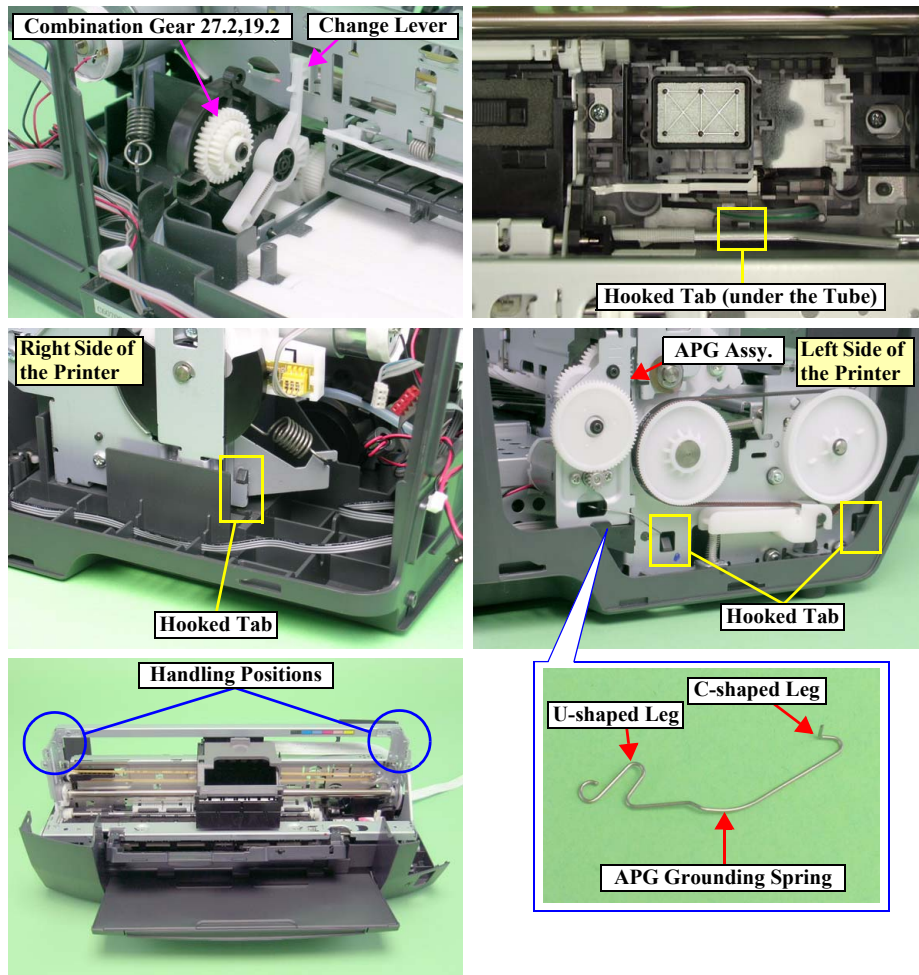

Figure 2-56. Removing the Printer Mechanism (2)

7. Release the U-shaped leg of the APG Grounding Spring from the notch of the APG Assy. and release the C-shaped leg of the spring from the notch of the Main Frame, then remove the APG Grounding Spring.



Beware of the following items when performing the next step.

- The Change Lever and the Combination Gear 27.2,19.2 may come off. Be careful not to drop and damage them.
- As remaining ink may leak or spatter from the tip of the Waste Ink Tube, have a waste cloth beforehand to wipe out it.
- When lifting the Printer Mechanism, be sure to hold it by the specified handling positions to prevent the Main Frame from deforming.
- The two tabs (□) on each of the home and the ant-home sides differs in orientation (releasing direction), so first release the two tabs (□) on both sides of the same orientation, and then release the other two tabs.

8. Release the four tabs (□) that secure the Printer Mechanism and lift the Printer Mechanism holding the left and right upper edges of the Main Frame to remove it.



When reinstalling the Printer Mechanism to the Lower Housing, be sure to set the Waste Ink Tube into the groove and the tab as shown in the figure below. And make sure that the Upper Ink Eject Porous Pad Support is securely attached on the tube. Improper installation of the tube and the pad may cause ink leakage.

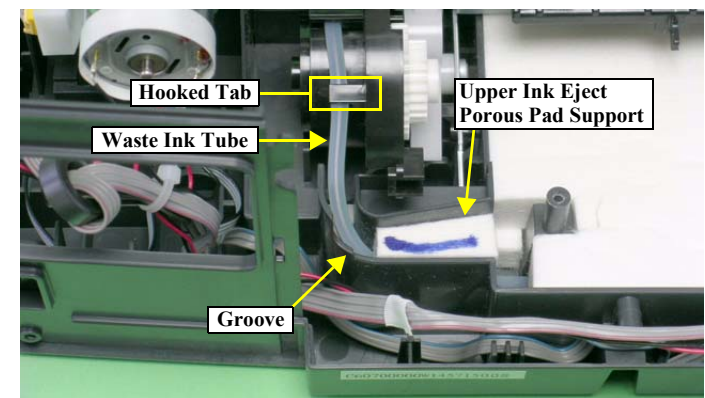

Figure 2-57. Reinstalling the Waste Ink Tube



■ The correct installation position of the Printer Mechanism is ensured by carefully checking the specified points in relation to the Lower Housing.

To ensure the installation accuracy, the position of the Main Frame must be checked in X, Y, and Z directions as described below. The Main Frame can be secured with the four hooked tabs and the two Main Frame Insulators only when the Main Frame is located at the correct position.

- [X direction]
 - Make sure that the bottom edge of the Main Frame is properly inserted into the groove on the Lower Housing.
 - Make sure there is no gap between the Main Frame and the Lower Housing.
- [Y direction]

Make sure that the notches of the Main Frame are properly engaged with the protrusions on the Lower Housing.
- [Z direction]
 - Make sure there is no gap between the Main Frame and the Lower Housing.
 - Make sure that the left side of the Printer Mechanism is correctly secured by the two tabs.
 - Make sure that the left side of the Printer Mechanism is correctly secured with the two Main Frame Insulators. If not, follow the procedure below to properly insert the insulators; While holding down the left frame of the CDR Guide Assy., lift the left side of the printer and from the bottom of the printer, rotate the insulator in both directions until it clicks.

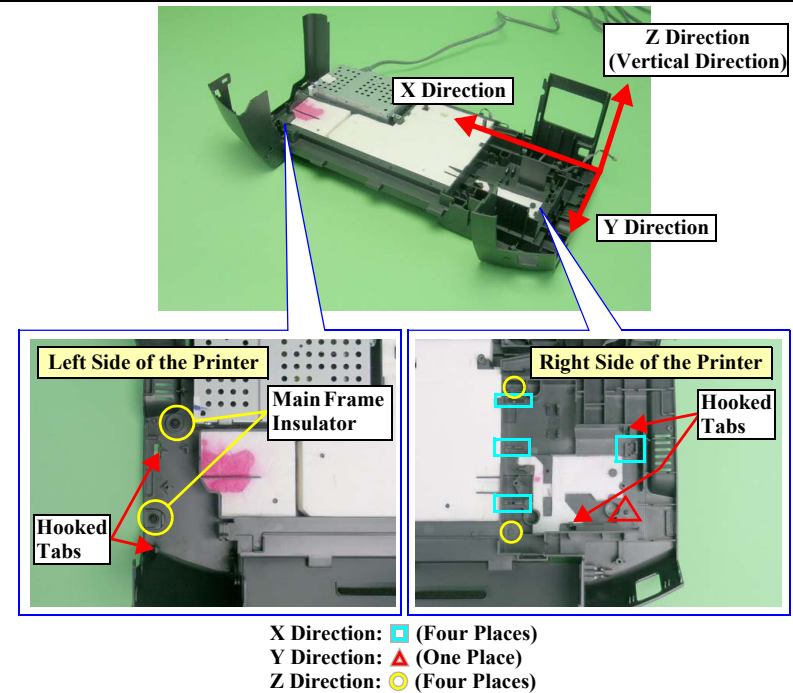

Figure 2-58. Reinstalling the Main Frame

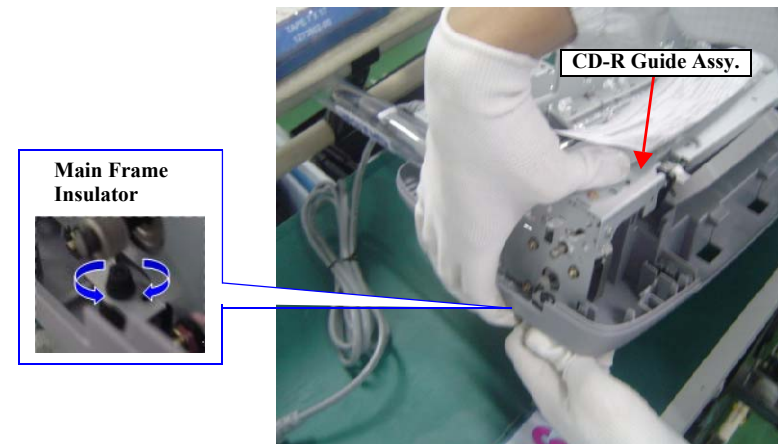

Figure 2-59. Inserting the Main Frame Insulators



- After making sure that the Waste Ink Tube is routed under the Lower Waste Ink Pad, attach the Upper Ink Eject Porous Pad Support to/in the position/orientation as shown in the figure below making it contact with the Waste Ink Tube.

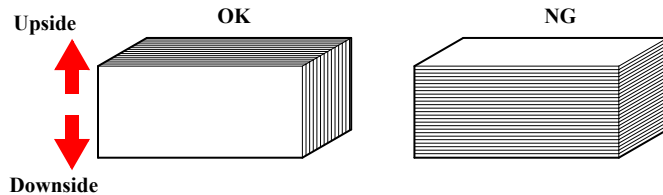
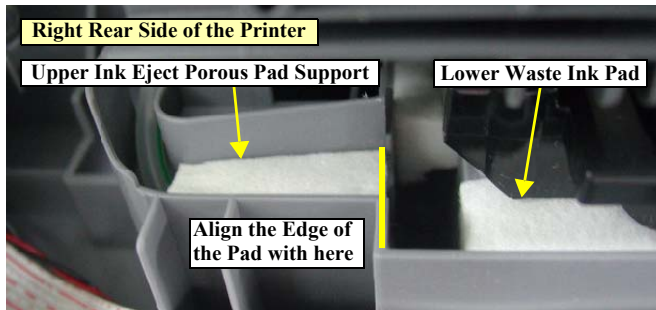

Figure 2-60. Reattaching the Upper Ink Eject Porous Pad Support

- Tie the following connector cables with a cable tie.
 - CR Motor (route the cable as shown in [Figure 2-50](#).)
 - PF Motor
 - PG Motor
 - Tray/CD-R Sensor
 - Power Supply Board
- After tying the cables, cut the cable tie leaving a 20 mm-length margin.
- Tighten the screws to secure the Printer Mechanism and the CD-R Paper Guide in the order shown in [Figure 2-55](#).
- Make sure that the Waste Ink Tube is free of flattening or compression.
- Make sure that the Cap Assy. moves smoothly.

2.3.16 Removing the Power Supply Assy.

□ Illustration

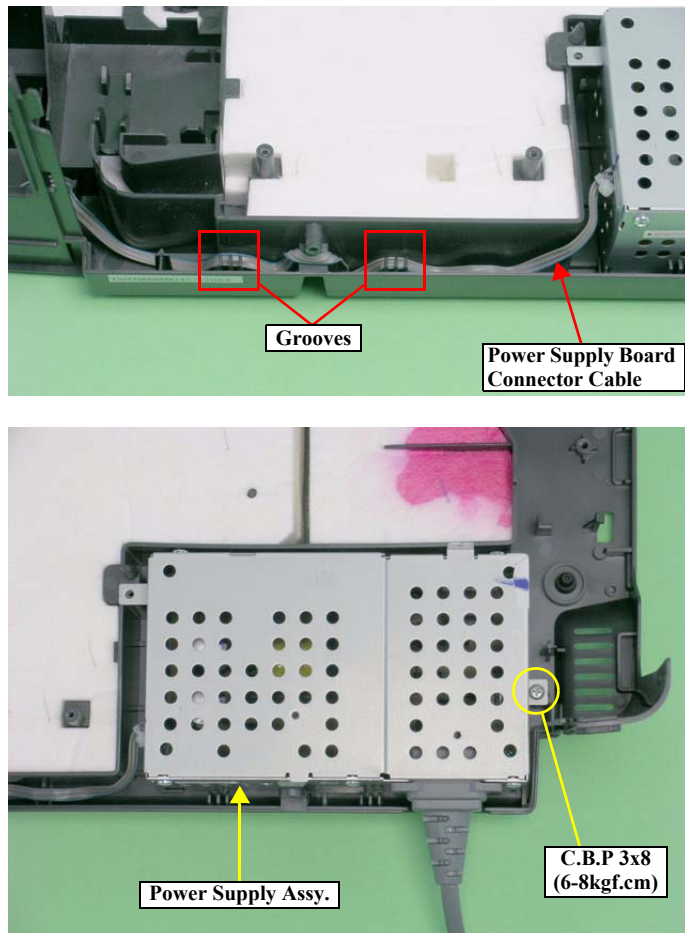

Figure 2-61. Removing the Power Supply Assy.

□ Parts/Components must be removed to remove the Power Supply Assy.

Paper Support Assy., Left Housing, Right Housing, Panel Board Assy. (Panel Board and LCD Module), Upper Housing, Rear Housing, Main Board Assy., ASF Assy., Shaft Assy. Holder, Printer Mechanism

□ Disassembly Procedure

1. Release the Power Supply Board connector cable from the two grooves (□) on the Lower Housing.
2. Remove the screw (○) that secures the Power Supply Assy., and remove it.



Route the cable twisting it as shown in the figure below.

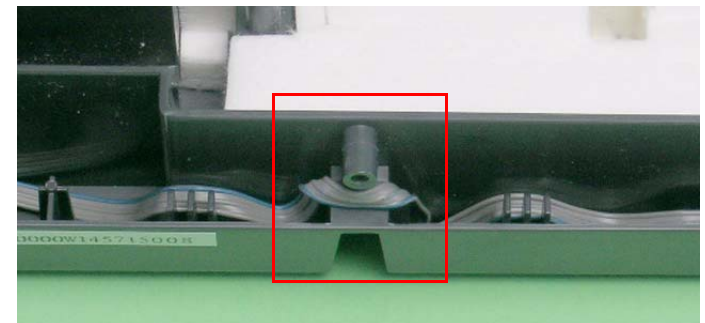

Figure 2-62. Routing the Power Supply Board Connector Cable



Whenever the Power Supply Assy. is replaced, be sure to perform the required adjustment shown below. (See Chapter 3 for details on the adjustments)

- Offset Input for CR Motor Calorific Limitation

2.3.17 Removing the Waste Ink Pads

□ Illustration

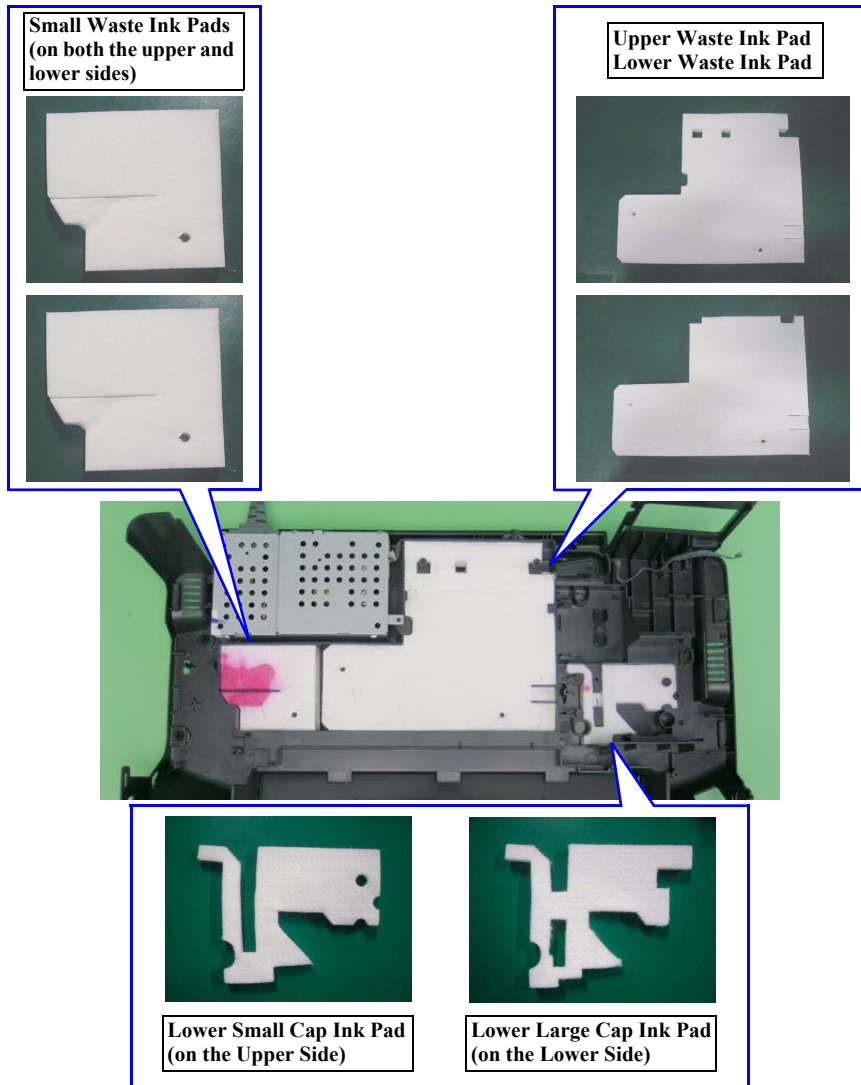

Figure 2-63. Removing the Waste Ink Pads

□ Parts/Components must be removed to remove the Waste Ink Pads.

Paper Support Assy., Left Housing, Right Housing, Panel Board Assy. (Panel Board and LCD Module), Upper Housing, Rear Housing, Main Board Assy., ASF Assy., Shaft Assy. Holder, Printer Mechanism, Power Supply Assy.

□ Disassembly Procedure

1. Remove the six Waste Ink Pads from the Lower Housing.



Reattach the six Waste Ink Pads so that their holes are properly set onto the ribs (□), guide pins (□) and tabs (□) on the Lower Housing.

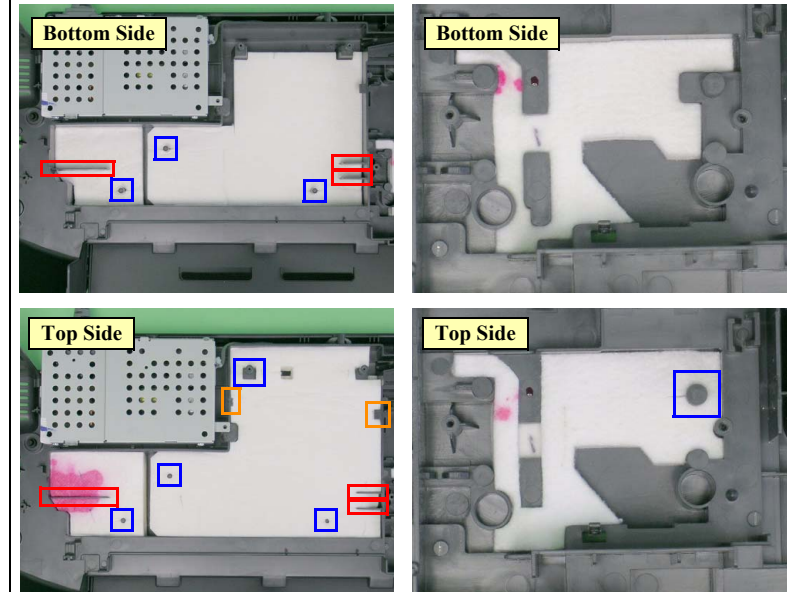

Figure 2-64. Reinstalling the Waste Ink Pads



Whenever the Waste Ink Pads are replaced, be sure to perform the required adjustment shown below. (See Chapter 3 for details on the adjustments)

- Protection counter

2.3.18 Removing the Lower Housing

□ Illustration

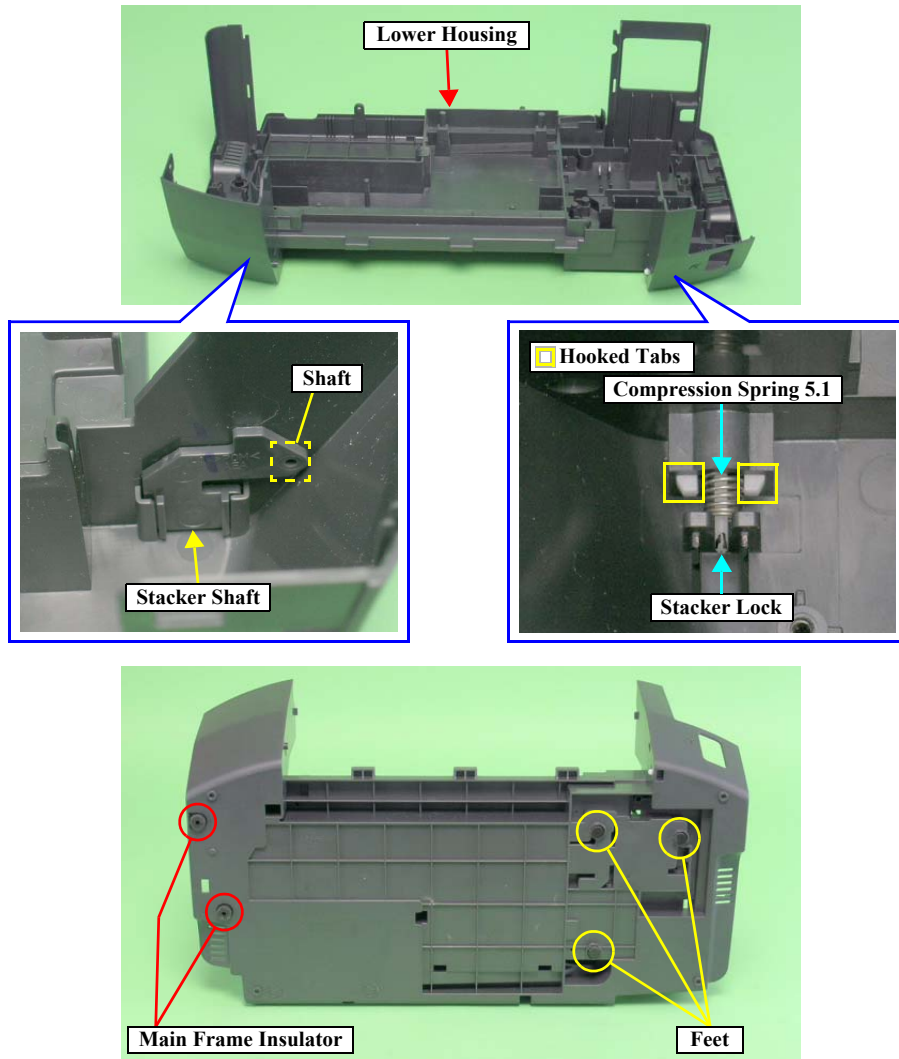

Figure 2-65. Removing the Lower Housing

□ Parts/Components must be removed to remove the Lower Housing.

Paper Support Assy., Left Housing, Right Housing, Panel Board Assy. (Panel Board and LCD Module), Upper Housing, Rear Housing, Main Board Assy., ASF Assy., Shaft Assy. Holder, Printer Mechanism, Power Supply Assy., Waste Ink Pads, Stacker Assy.

□ Disassembly Procedure

1. Release the two tabs (□) that secure the Stacker Lock and remove the Stacker Lock and the Compression Spring 5.1.
2. Release the shaft of the Stacker Shaft with a flat-blade screwdriver and remove the Stacker Shaft.
3. Remove the three feet affixed on the bottom of the Lower Housing.
4. Remove the two Main Frame Insulators from the Lower Housing.

2.3.19 Removing the APG Assy.

□ Illustration

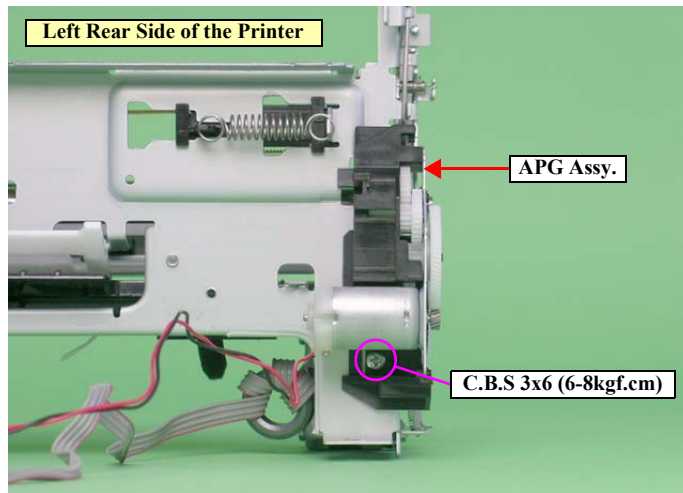

Figure 2-66. Removing the APG Assy.

□ Parts/Components must be removed to remove the APG Assy.

Paper Support Assy., Left Housing, Right Housing, Panel Board Assy. (Panel Board and LCD Module), Upper Housing, Rear Housing, Main Board Assy., ASF Assy., Shaft Assy. Holder, Printer Mechanism

□ Disassembly Procedure

1. Remove the screw (○) that secures the APG Assy., and remove it.



Reinstall the APG Assy. in the order given below.

1. Set the two tabs (□) into the corresponding holes on the Main Frame.
2. Insert the arm into the slit of the Main Frame.
3. Set the two guide pins (□) into the positioning holes.

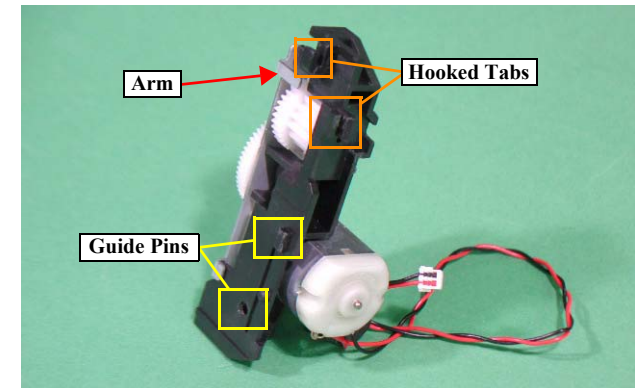

Figure 2-67. Reinstalling the APG Assy.

2.3.20 Removing the Carriage Unit

□ Illustration (1)

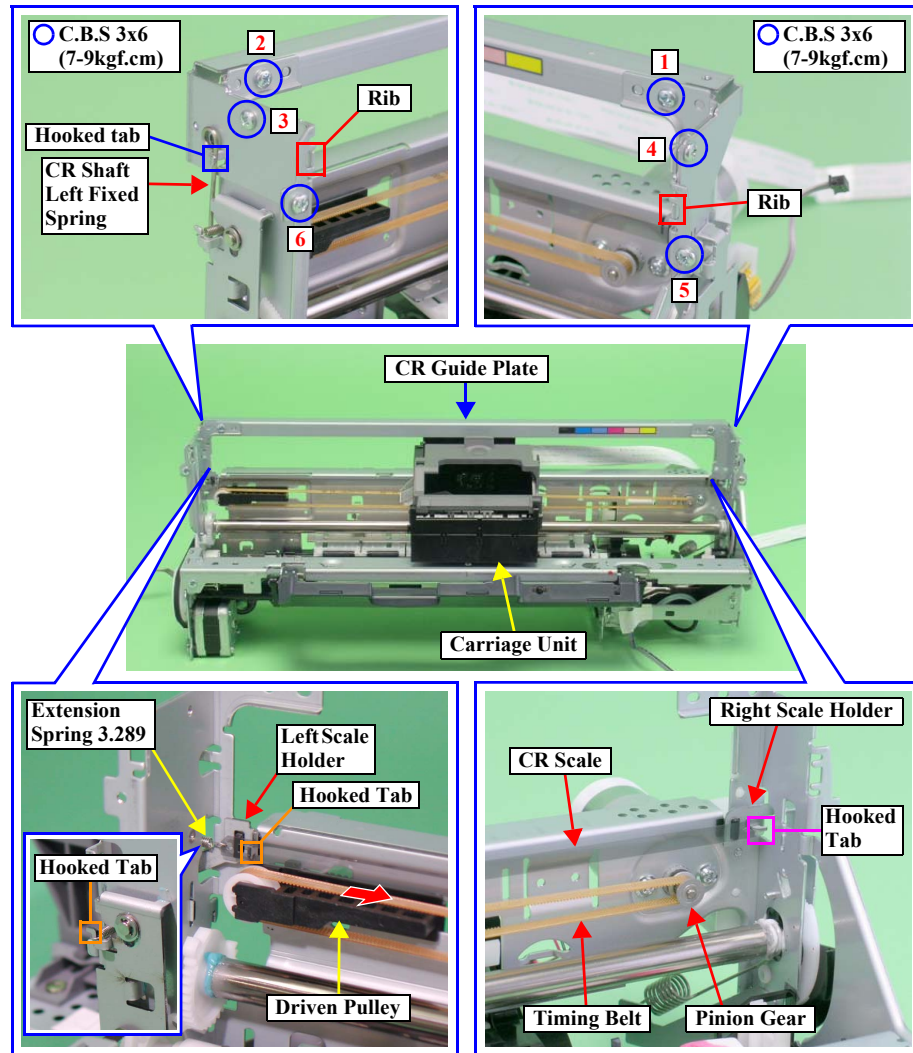

Figure 2-68. Removing the Carriage Unit (1)

□ Parts/Components must be removed to remove the Carriage Unit.

Paper Support Assy., Left Housing, Right Housing, Panel Board Assy. (Panel Board and LCD Module), Upper Housing, Rear Housing, Main Board Assy., ASF Assy., Shaft Assy. Holder, Printer Mechanism, APG Assy., Print Head

□ Disassembly Procedure

1. Release the tab (□) of the Main Frame that secures the CR Shaft Left Fixed Spring and remove the spring.
2. Remove the six screws (○) that secure the CR Guide Plate.
3. Release the CR Guide Plate from the two ribs (□), and remove it avoiding a contact with the tab (□) that was securing the CR Shaft Left Fixed Spring.
4. Release the right edge of the CR Scale from the tab (□) of the Right Scale Holder.
5. Pull out the CR Scale leftward from behind the printer, and remove the CR Scale and the Extension Spring 3.289 from the tabs (□) of the Left Scale Holder in that order.
6. Remove the Extension Spring 3.289 from the CR Scale.
7. Press the Driven Pulley rightward to reduce the tension of the Timing Belt, and remove the Timing Belt from the pinion gear of the CR Motor and the Driven Pulley in that order.

□ Illustration (2)

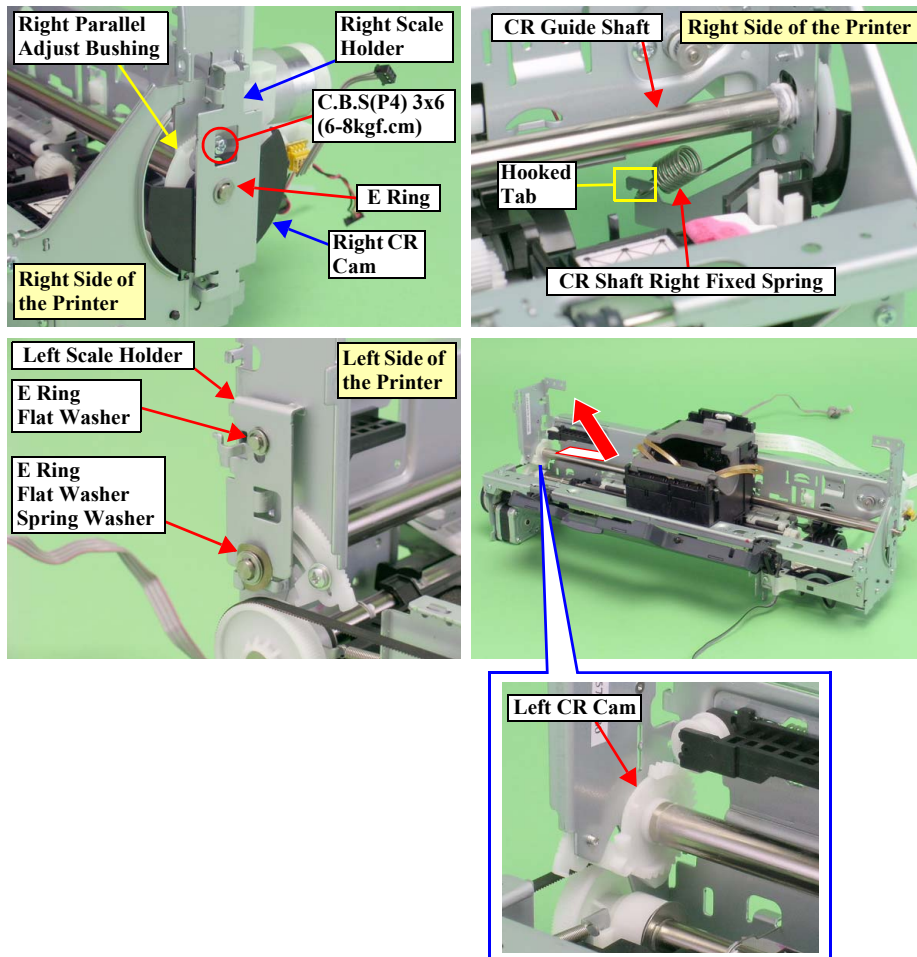

Figure 2-69. Removing the Carriage Unit (2)



When performing the next step, be careful not to lose the Scale Holder Sliders.

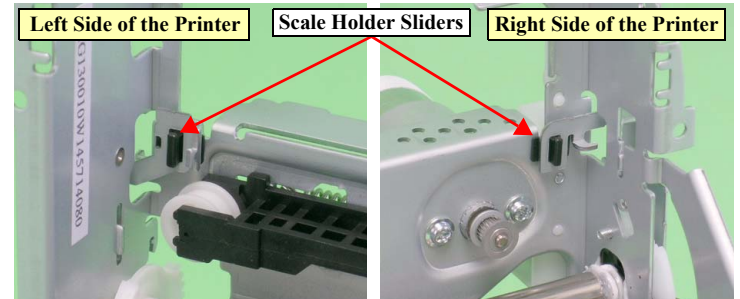

Figure 2-70. Scale Holder Sliders

8. Remove the E ring from the right edge of the CR Guide Shaft, and remove the Right Scale Holder, Right CR Cam and the Scale Holder Slider.
9. Remove the screw (○) that secures the Right Parallel Adjust Bushing and remove it.
10. Release the CR Shaft Right Fixed Spring from the tab (□) of the Main Frame, and remove the spring from the CR Guide Shaft.
11. Remove the upper E ring and flat washer that secure the Left Scale Holder.
12. Remove the lower E ring, flat washer and spring washer that secure the Left Scale Holder and remove the Left Scale Holder.
13. Slide the CR Guide Shaft rightward to pull it out of the Left CR Cam and Main Frame, and remove the Carriage Unit together with the CR Guide Shaft.
14. Pull out the CR Guide Shaft from the Carriage Unit.

□ Illustration (3)

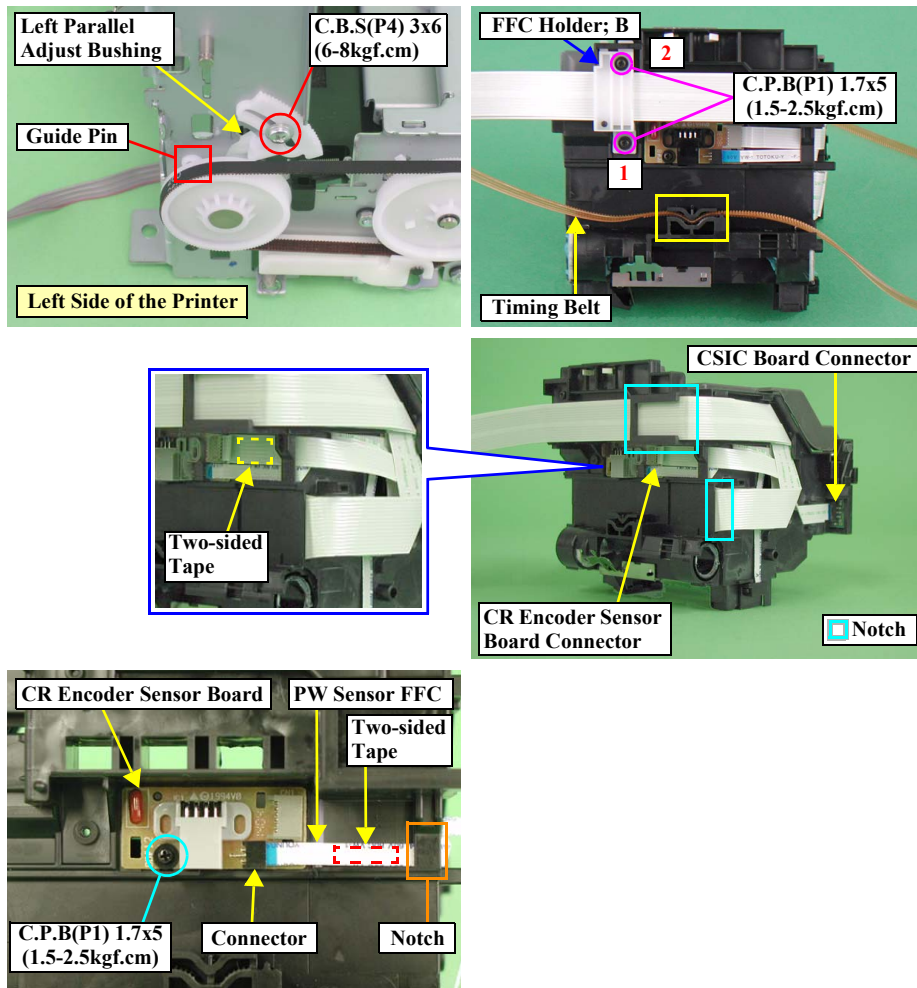

Figure 2-71. Removing the Carriage Unit (3)

15. Remove the screw (○) that secures the Left Parallel Adjust Bushing.
16. Pull out the guide pin (□) of the Left Parallel Adjust Bushing and remove it.
17. Remove the Timing Belt from the groove (□) of the Carriage Unit.
18. Remove the two screws (○) that secure the FFC Holder; B with a No.1 screwdriver and remove it.
19. Disconnect the Head Cable from the CSIC Board.
20. Remove the two-sided tape that secures the Head Cable and disconnect it from the CR Encoder Sensor Board.
21. Pull out the Head Cable through the two notches (□) of the Carriage Unit.

■ Removing the CR Encoder Sensor

1. Remove the screw (○) that secures the CR Encoder Sensor Board with a No.1 screwdriver.
2. Remove the two-sided tape that secures the PW Sensor FFC.
3. Disconnect the PW Sensor FFC from the CR Encoder Sensor Board, and remove the board.

□ Illustration (4)

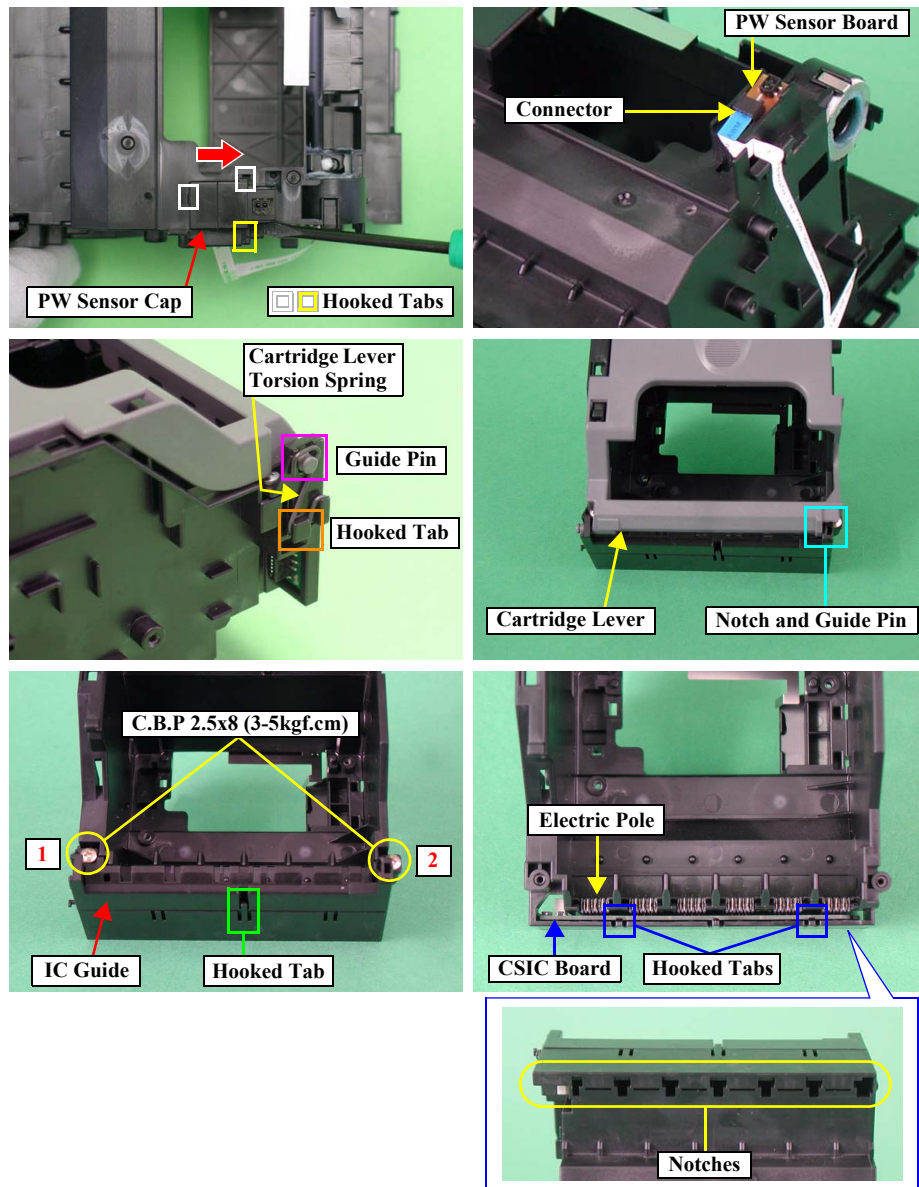



Figure 2-72. Removing the Carriage Unit (4)

■ Removing the PW Sensor Board

1. While pressing the PW Sensor Cap in the direction of the arrow shown in [Figure 2-72](#), insert a flat-blade screwdriver between the tab (□) of the PW Sensor Cap and the Carriage to release the three tabs (□□), and remove the PW Sensor Cap.

CAUTION
 Prevent the PW Sensor Board from falling down when removing the PW Sensor Cap as the board is secured by the cap and becomes unstable after the cap is removed.

2. Pull out the PW Sensor FFC through the notch (□ [See Figure 2-71.](#)) of the Carriage Unit, and disconnect the FFC from the PW Sensor Board, then remove it together with the PW Sensor Board.

■ Removing the CSIC Board

1. Remove the Cartridge Lever Torsion Spring from the guide pin (□) of the Cartridge Lever and the tab (□) of the IC Guide.
2. Pull out the guide pin (□) of the Cartridge Lever from the right notch of the IC Guide with tweezers, and remove the Cartridge Lever
3. Remove the two screws (○) that secure the IC Guide, and release the tab (□) with tweezers, then remove the IC Guide.
4. Release the two tabs (□) that secure the CSIC Board, and push up the board with a flat-blade screwdriver inserting it from the bottom notch of the Carriage Unit to remove the CSIC Board.

CAUTION
 Be careful not to damage the electric pole with the flat-blade screwdriver while removing the CSIC Board.



- **Reinstalling the CSIC Board**
 - Make sure that the CSIC Board is securely fitted onto the correct position.
 - Tighten the screws to secure the IC Guide in the order shown in [Figure 2-72](#).
- **Reinstalling the PW Sensor Board**
 - Make sure that the PW Sensor FFC is correctly connected.
 - Make sure that the PW Sensor Board is properly secured with the PW Sensor Cap.
- **Reinstalling the CR Encoder Sensor Board**
 - Make sure that the CR Encoder Sensor FFC is correctly connected.
- **Reinstalling the FFC Holder; B**
 - Tighten the screws in the order shown in [Figure 2-71](#).
- **Reinstalling the Carriage Unit**
 - Set a portion of the Timing Belt that has serrated surfaces on both sides into the groove of the Carriage Unit.
 - Make sure that the Head Grounding Plate is installed at the correct position on the Carriage Unit.

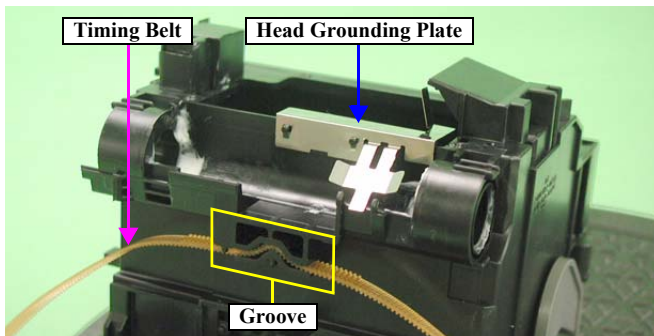

Figure 2-73. Head Grounding Plate Installation Position



- **Reinstalling the Right/Left Scale Holders**
 - Be sure to attach the Scale Holder Sliders to the both left and right Scale Holders before reinstalling the holders.

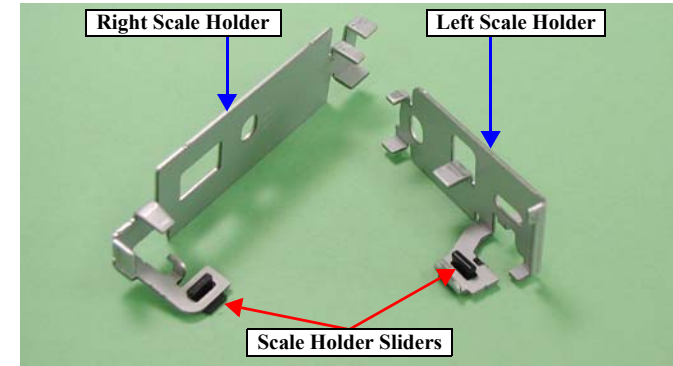

Figure 2-74. Reattaching the Scale Holder Sliders

- **Reinstalling the E Ring**
 - Be sure to attach the E ring with its smoother surface facing outward.



Figure 2-75. Attaching the E Ring



■ Reinstalling the CR Scale

- Make sure that the Extension Spring 3.289 is not twisted.
- The cut corner of the left edge of the CR Scale should face upward.



Figure 2-76. Reinstalling the CR Scale (1)

- Make sure to reinstall the CR Scale so that it runs through the slit of the CR Encoder Sensor.

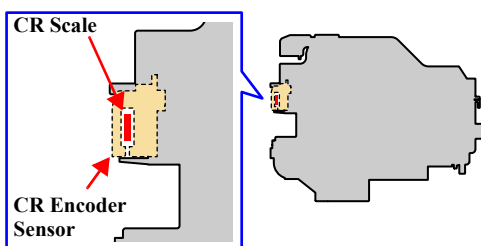

Figure 2-77. Reinstalling the CR Scale (2)

■ Reinstalling the CR Guide Plate

- Tighten the screws in the order shown in [Figure 2-68](#).

■ Reinstalling the CR Shaft Left Fixed Spring

- Put the CR Shaft Left Fixed Spring on the CR Guide Shaft and secure the spring with the two tabs (○) of the Main Frame.

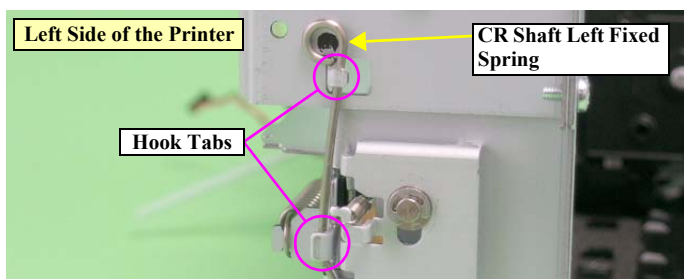

Figure 2-78. Reinstalling the CR Shaft Left Fixed Spring



■ Whenever any of the following parts are replaced, be sure to lubricate them with the specified oil. (See Chapter 4 for details on the lubrication)

- Left or Right CR Cam
- CR Guide Shaft
- Left or Right Scale Holder
- Driven Pulley Assy.
- CR Guide Plate
- Head Grounding Plate

■ Whenever the Carriage Unit or the CR Guide Shaft is reinstalled or replaced, be sure to perform the required adjustments in the order given below. (See Chapter 3 for details on the adjustments)

1. PG adjustment
2. First Dot adjustment
3. PW Sensor adjustment
4. Head Angle adjustment (only when the Carriage Unit is reinstalled or replaced)
5. Bi-D Adjustment
6. Offset Input for CR Motor Calorific Limitation (only when the Carriage Unit is replaced)

■ Whenever the PW Sensor is reinstalled or replaced, be sure to perform the required adjustment shown below. (See Chapter 3 for details on the adjustments)

- PW Sensor adjustment

2.3.21 Removing the CD-R Guide Assy.

□ Illustration (1)

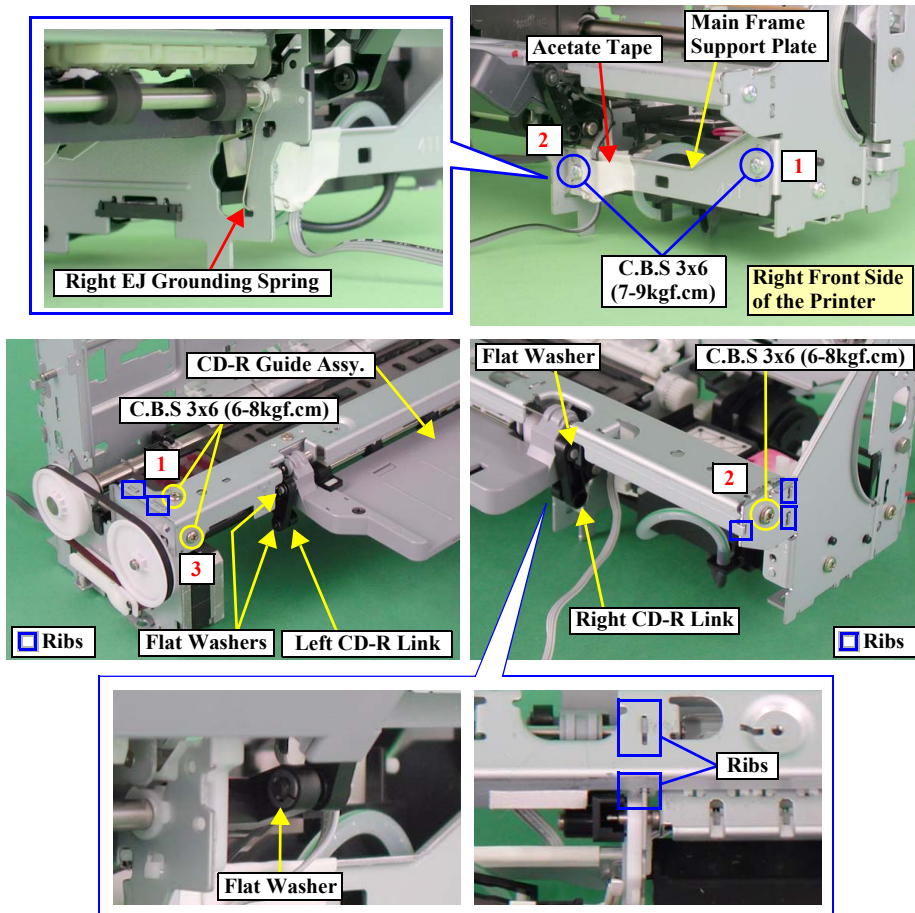

Figure 2-79. Removing the CD-R Guide Assy. (1)

□ Parts/Components must be removed to remove the CD-R Guide Assy.

Paper Support Assy., Left Housing, Right Housing, Panel Board Assy. (Panel Board and LCD Module), Upper Housing, Rear Housing, Main Board Assy., ASF Assy., Shaft Assy. Holder, Printer Mechanism, APG Assy., Print Head, Carriage Unit

□ Disassembly Procedure

1. Remove the acetate tape and release the connector cable of the Tray/CD-R Sensor.
2. Remove the Right EJ Grounding Spring from the Main Frame and the EJ Roller Assy.
3. Remove the two screws (○) that secure the Main Frame Support Plate, and remove it.
4. Remove the three screws (●) that secure the CD-R Guide Assy.
5. Remove the flat washers that secure the Left and Right CD-R Links (two washers for each) with tweezers, then remove the Left/Right CD-R Links from the CD-R Guide Assy.
6. Release the seven ribs (□) that secure the CD-R Guide Assy. and remove it first from its right side.

□ Illustration (2)

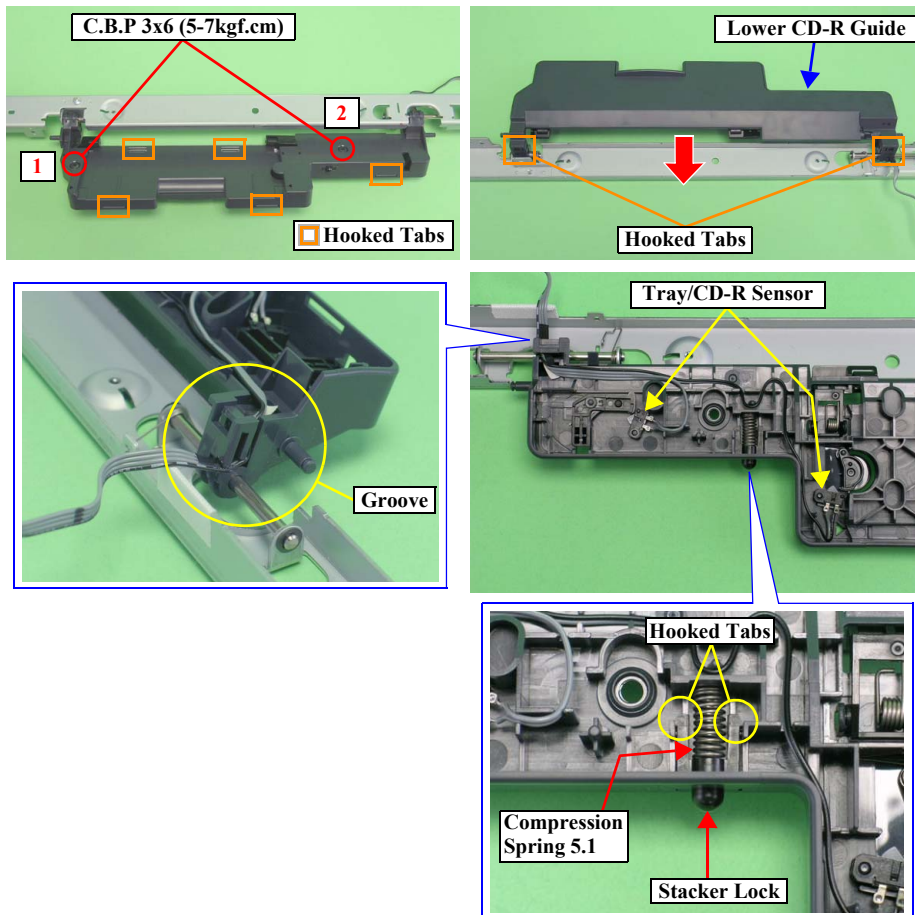

Figure 2-80. Removing the CD-R Guide Assy. (2)

7. Remove the two screws (○) that secure the Lower CD-R Guide.



When performing the following steps, be careful not to lose the parts listed below.

- Tray Sensor Lever
- CD-R Sensor Lever
- Torsion Spring 2.8
- Torsion Spring 4.26

8. Slide the Lower CD-R Guide to release it from the seven tabs (□) and remove it.
9. Remove the Compression Spring 5.1 and the Stacker Lock from the Upper CD-R Guide.
10. Release the connector cable of the Tray/CD-R Sensor from the groove of the Upper CD-R Guide, and remove the Tray/CD-R Sensor.



■ Reinstalling the Tray/CD-R Sensor

- Set the two positioning holes of the Tray/CD-R Sensor onto the two guide pins.

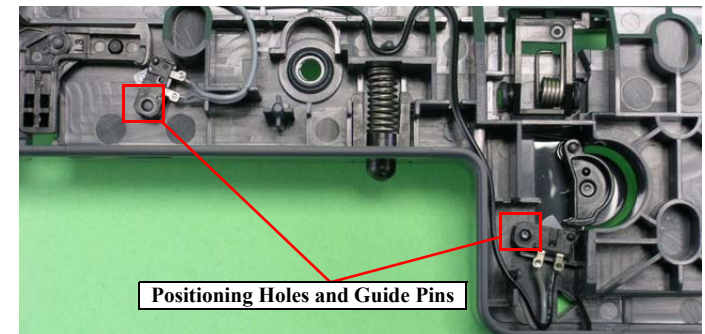

Figure 2-81. Reinstalling the Tray/CD-R Sensor

- Route the connector cable of the Tray/CD-R Sensor as shown in [Figure 2-80](#).



■ **Reinstalling the Tray Sensor Lever**

- Insert the Torsion Spring 2.8 onto the shaft of the Upper CD-R Guide.
- Pull the L-shaped leg of the Torsion Spring 2.8 with tweezers in the direction shown in the figure below.
- Set the positioning hole (□) of the Tray Sensor Lever onto the shaft of the Upper CD-R Guide, and hitch the L-shaped leg of the Torsion Spring 2.8 to the position shown below.

Figure 2-82. Reinstalling the Tray Sensor Lever



■ **Reinstalling the CD-R Sensor Lever**

- Insert the Torsion Spring 4.26 onto the shaft of the Upper CD-R Guide.
- Set the positioning hole (□) of the CD-R Sensor Lever onto the shaft of the Upper CD-R Guide, and hitch the L-shaped leg of the Torsion Spring 4.26 to the position shown below.

Figure 2-83. Reinstalling the CD-R Sensor Lever

- **Reinstalling the Lower CD-R Guide**
 - Tighten the screws in the order shown in [Figure 2-80](#).
- **Reinstalling the Upper CD-R Guide**
 - Make sure that the two tabs of the Stacker Lock are properly secured with a tension of the Compression Spring 5.1. See [Figure 2-80](#).
 - After reinstalling the Lower CD-R Guide, make sure there is no gap between the Lower and Upper CDR Guides.



- Reinstalling the CD-R Guide Assy.
 - Install the CD-R Guide Assy. first from its left side, and right side, and then the center portion.
 - Move the coiled part of the Right EJ Grounding Spring in the direction of the arrow, and hitch the shorter leg of the spring to the tab of the CD-R Guide Assy. while holding the other longer leg with your fingers. Bring the longer leg to contact with the surface of the EJ Roller Assy.

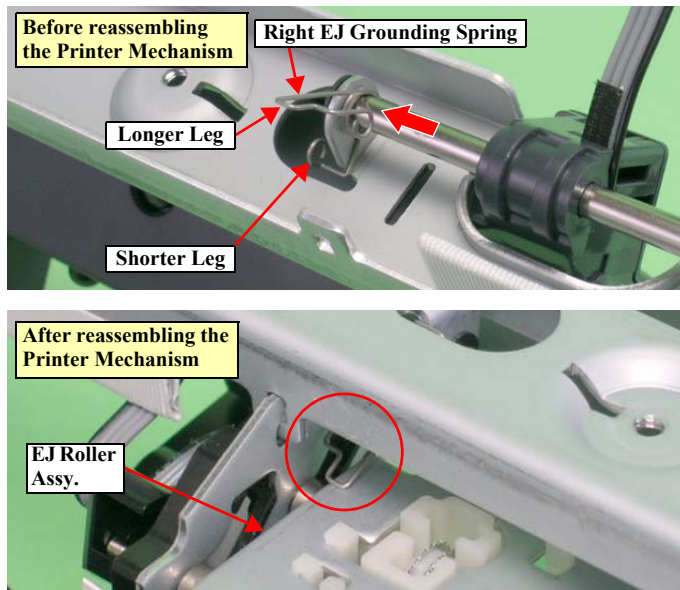

Figure 2-84. Reattaching the Right EJ Grounding Spring

- Make sure that the Left and Right CD-R Links are correctly installed.
- Make sure that the connector cable of the Tray/CD-R Sensor does not interfere with the Right CD-R Link.
- Make sure that the EJ Frame Assy. moves smoothly together with the CD-R Guide Assy.
- Reinstalling the Main Frame Support Plate
 - Tighten the screws in the order shown in [Figure 2-79](#).

2.3.22 Removing the Ink System

□ Illustration (1)

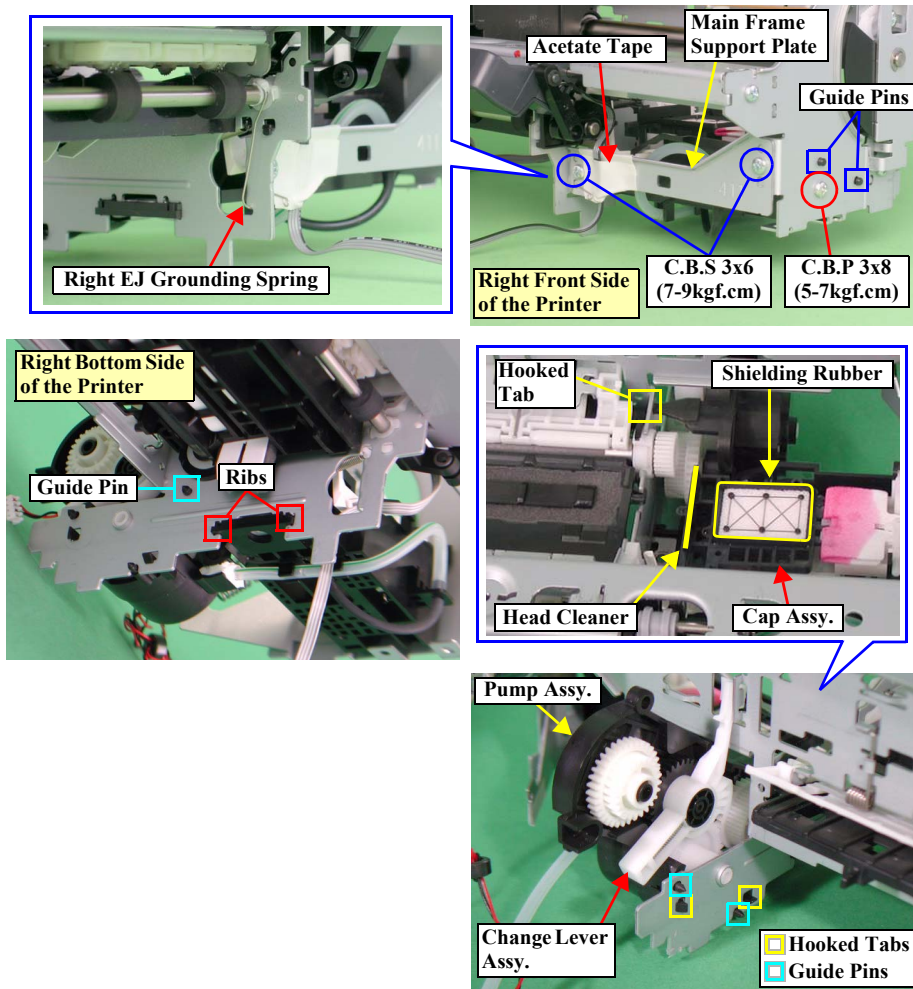

Figure 2-85. Removing the Ink System (1)

□ Parts/Components must be removed to remove the Ink System.

Paper Support Assy., Left Housing, Right Housing, Panel Board Assy. (Panel Board and LCD Module), Upper Housing, Rear Housing, Main Board Assy., ASF Assy., Shaft Assy. Holder, Printer Mechanism

□ Disassembly Procedure

1. Remove the acetate tape and release the connector cable of the Tray/CD-R Sensor.
2. Remove the Right EJ Grounding Spring from the Main Frame and the EJ Roller Assy.
3. Remove the two screws (○) that secure the Main Frame Support Plate, and remove it.
4. Remove the screw (○) that secures the Cap Assy.



Beware of the following items when performing the next step.

- Never touch and damage the Head Cleaner and the Shielding Rubber.
- Do not disconnect the Ink Tubes that connected to the Cap Assy. and the Pump Assy.
- The Ink Tubes are adjusted to its optimum length and anchored to the Pump Assy. with silicon material to prevent ink leakage. Never attempt to disconnect the tubes from the Pump Assy.

5. Slide the Cap Assy. toward the inside of the Printer Mechanism to release the Cap Assy. from the two guide pins (□), and remove the Cap Assy. from the two ribs (□) of the Main Frame.
6. Release the three tabs (□) and three guide pins (□) that secure the Pump Assy., and remove it together with the Cap Assy. while holding the Change Lever Assy. and the all gears with your hand to prevent them falling.

□ Illustration (2)

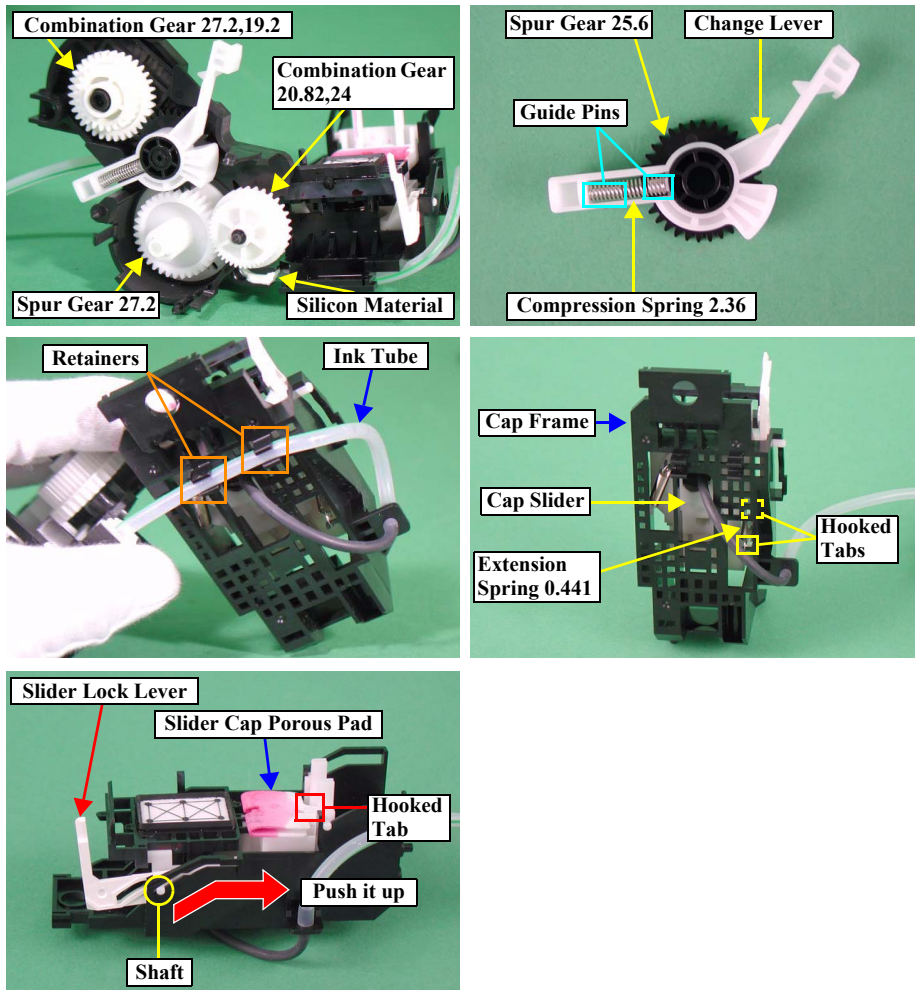

Figure 2-86. Removing the Ink System (2)

7. Remove the Combination Gear 20.82,24, Spur Gear 27.2, Change Lever Assy., Combination Gear 27.2,19.2 from the Pump Assy.
8. Remove the Spur Gear 25.6 from the Change Lever.
9. Remove the Compression Spring 2.36 from the two guide pins (□) of the Change Lever.
10. Release the Ink Tube from the two retainers (□) on the bottom of the Cap Frame.
11. Remove the Extension Spring 0.441 from the tabs (□) of the Cap Slider and the Cap Frame with tweezers.
12. Push the Cap Slider up to remove the shaft from the notch of the Cap Frame, and remove the Slider Lock Lever.
13. Remove the Cap Slider Porous Pad from the tab (□) of the Cap Slider with tweezers.



■ Reinstalling the Cap Slider Porous Pad

- Bend the Cap Slider Porous Pad along with the red line.
- Insert the tab of the Cap Slider Porous Pad into the hole, and set the two positioning holes of the pad onto the tab.

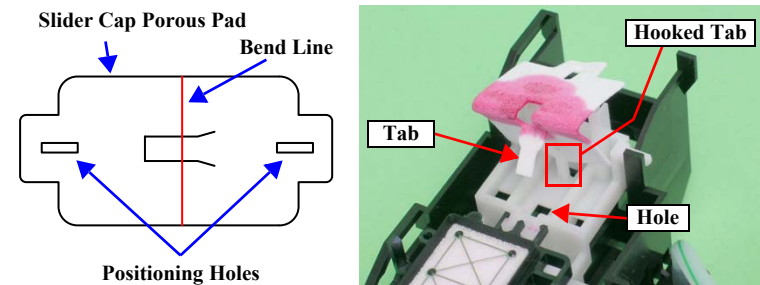

Figure 2-87. Reattaching the Cap Slider Porous Pad



- Reinstalling the Slider Lock Lever
 - Make sure that the Slider Lock Lever moves correctly together with the Cap Slider.
- Reinstalling the Ink System
 - Make sure that the Ink Tube is connected at the position shown in the figure below. Improper connection of the tube may cause ink leakage.

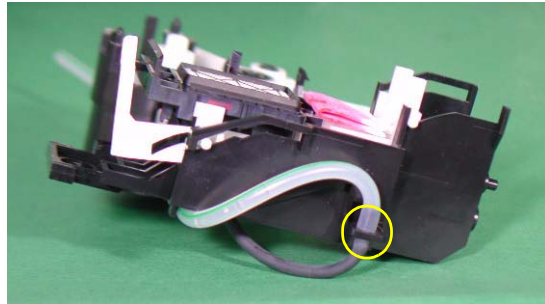

Figure 2-88. Ink Tube Connection Position

- Check the green line printed on the Ink Tube to make sure that the tube is not twisted.
- Make sure that the Cap Assy. moves smoothly.
- Make sure that the all gears are correctly set to the shaft of the Pump Frame and move smoothly.
- Make sure the Pump Assy. is correctly secured.
- Make sure the Ink Tube is free of flattening or compression.



- Face the green line on the Ink Tube in the direction of the arrow, and attach the tube to the two retainers (□) on the bottom of the Cap Frame in the order shown below.

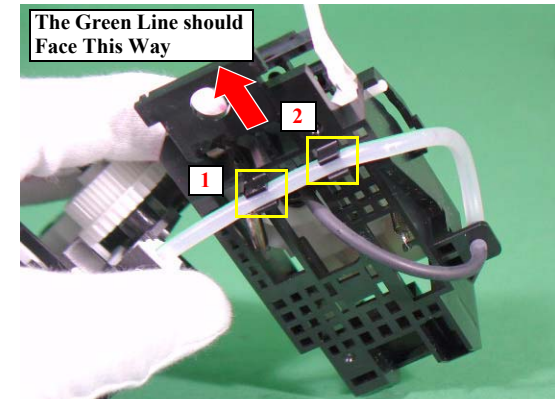

Figure 2-89. Reinstalling the Ink Tube

- Reinstalling the Main Frame Support Plate
 - Set the four positioning holes (□) of the Main Frame Support Plate onto the guide pins.
 - Tighten the screws in the order shown below.

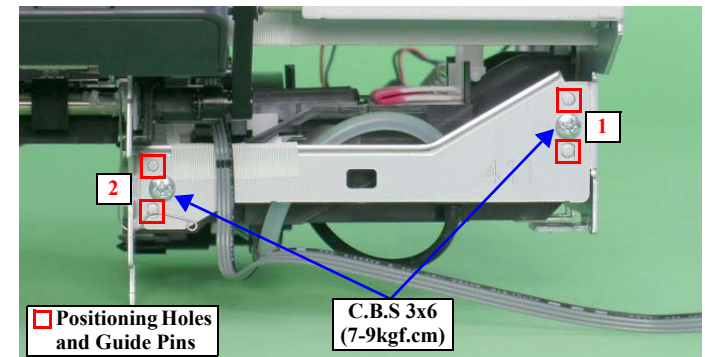

Figure 2-90. Reinstalling the Main Frame Support Plate

2.3.23 Removing the Front Paper Guide and EJ Roller Assy.

□ Illustration (1)

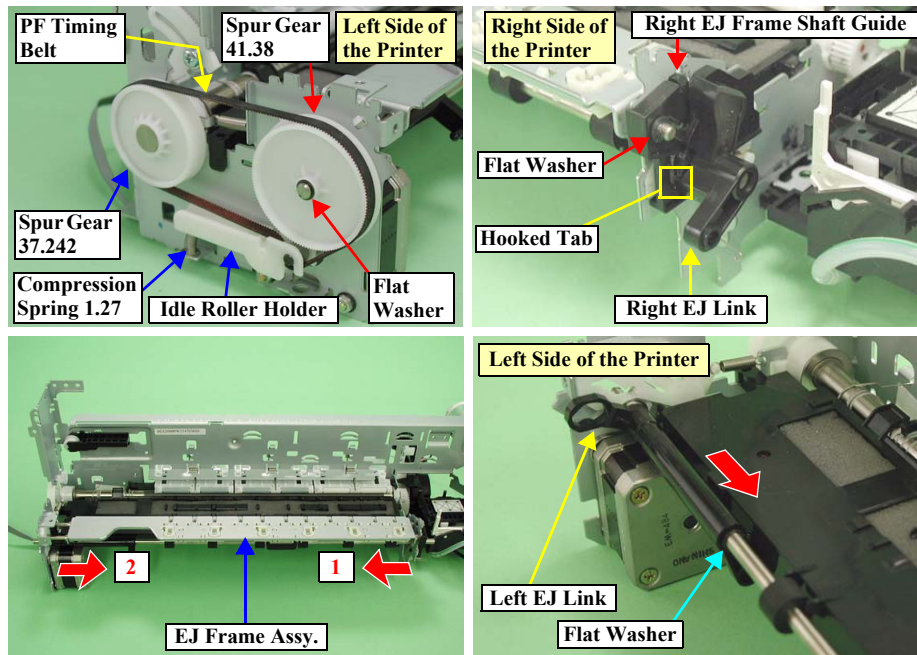

Figure 2-91. Removing the Front Paper Guide and EJ Roller Assy. (1)

- Parts/Components must be removed to remove the Front Paper Guide and EJ Roller Assy.

Paper Support Assy., Left Housing, Right Housing, Panel Board Assy. (Panel Board and LCD Module), Upper Housing, Rear Housing, Main Board Assy., ASF Assy., Shaft Assy. Holder, Printer Mechanism, APG Assy., Print Head, Carriage Unit, CD-R Guide Assy.

□ Disassembly Procedure

1. Release the tab (□) of the Right EJ Link from the groove of the Right EJ Frame Shaft Guide, and remove the Right EJ Link.
2. Remove the flat washer that secures the right side of the EJ Frame Assy.

CAUTION



When performing the next step, be careful not to lose the Compression Spring 1.27 as it comes off when the tension of the Idle Roller Holder is reduced.

3. Release the PF Timing Belt from the Spur Gear 37.242 and the Spur Gear 41.38.
4. Remove the flat washer that secures the Spur Gear 41.38 and pull out the Spur Gear 41.38.

CAUTION



When performing the next step, be careful not to damage or deform the Star Wheels incorporated in the EJ Frame Assy.

5. Remove the EJ Frame Assy. in the order and orientation shown in [Figure 2-91](#).
6. Remove the flat washer that secures the Left EJ Link and slide the Left EJ Link rightward.

□ Illustration (2)

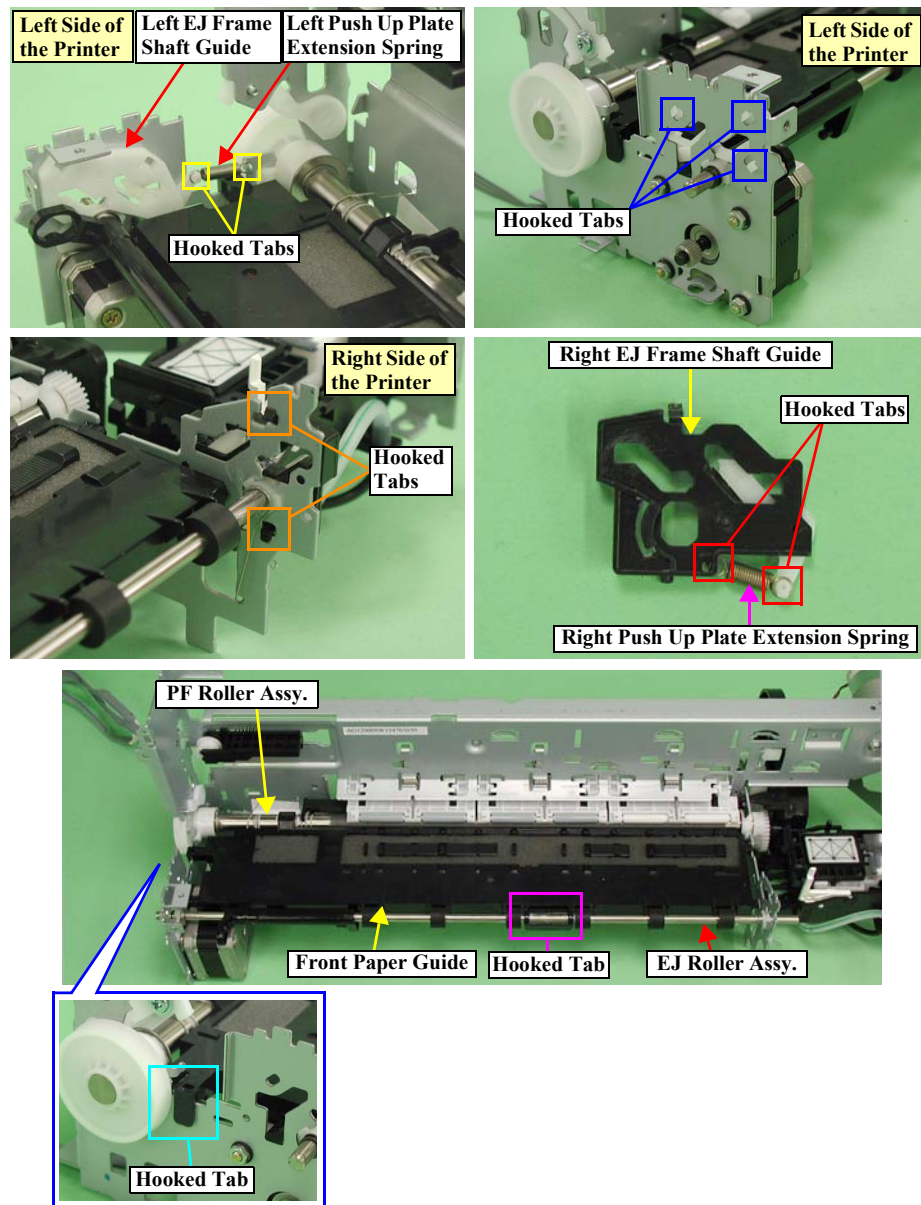

Figure 2-92. Removing the Front Paper Guide and EJ Roller Assy. (2)

7. Remove the Left Push Up Plate Extension Spring from the tabs (□) of the Left EJ Frame Shaft Guide and the Main Frame.
8. Release the five tabs (three on the left (□), two on the right (□)) that secure the Left/Right EJ Frame Shaft Guides, and remove them.
9. Remove the Right Push Up Plate Extension Spring from the two tabs (□) of the Right EJ Frame Shaft Guide.



Beware of the following items when performing the next step.

- Do not touch the Front Paper Guide Porous Pad and the Front Paper Guide Left Porous Pad.
- Be careful not to damage the ribs on the Front Paper Guide.
- Exercise care not to scratch the surface of the PF Roller Assy.

10. Release the left tab (□) that secures the Front Paper Guide, and release the front tab (□) to remove the Front Paper Guide.
11. Remove the Front Paper Guide Porous Pad, Front Paper Guide Left Porous Pad, and the three Front Paper Guide Support Porous Pads from the Front Paper Guide. See Section on page 52.

□ Illustration (3)

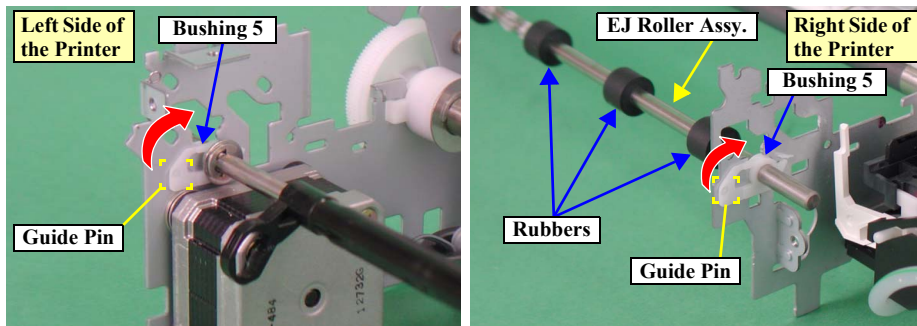

Figure 2-93. Removing the Front Paper Guide and EJ Roller Assy. (3)

12. Pull out the two guide pins () of the left and right Bushing 5s that secure the EJ Roller Assy., and rotate the bushings in the direction of the arrow.

CAUTION



When performing the next step, be careful not to damage the rubbers of the EJ Roller Assy.

13. Pull out the right Bushing 5 rightward from the shaft, and pull out the left and right edges of the EJ Roller Assy. from the Main Frame (first from the left and then right edge).



- Reinstalling the EJ Roller Assy.
 - Make sure the left and right Bushing 5s are correctly secured.
 - When attaching the PF Timing Belt, be careful not to damage the teeth of the Spur Gear 41.38.
 - Make sure the EJ Roller Assy. moves smoothly.
- Reinstalling the Front Paper Guide
 - Make sure the two guide pins (□) and the tab (□) of the Front Paper Guide are correctly set into the holes of the Main Frame.

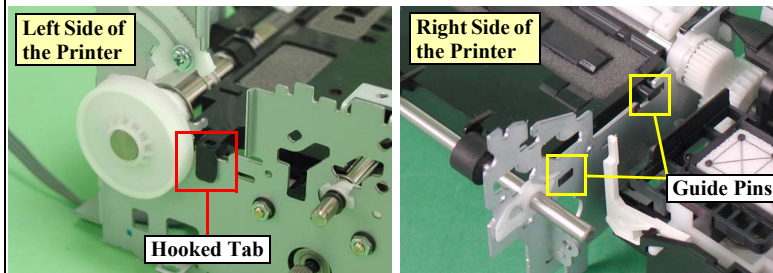

Figure 2-94. Reinstalling the Front Paper Guide

- Make sure the tabs of the Front Paper Guide Left Porous Pad and the Front Paper Guide Support Porous Pads are pulled out straight down through the notch of the Front Paper Guide.
- Make sure there is no gap between the Front Paper Guide and the Main Frame.
- If ribs on the Front Paper Guide are contaminated with leaked ink, wipe it off with a cotton bud. Be careful not to touch the Front Paper Guide Porous Pad with the cotton bud.



- Reinstalling the EJ Frame Assy.
 - Put the left rear shaft of the EJ Frame Assy. through the hole of the left EJ Link.

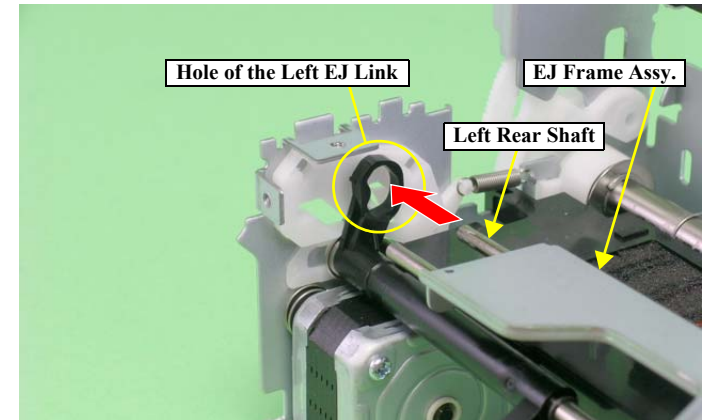

Figure 2-95. Reinstalling the EJ Frame Assy.



- Whenever any one of the following parts are replaced, be sure to apply proper amount of the specified oil to them. (See Chapter 4 for details on the lubrication.)
 - Idle Roller Holder
 - Front Paper Guide
 - Left/Right EJ Frame Shaft Guides
 - EJ Roller Assy.
 - Bushing 5
- Whenever the Front Paper Guide is reinstalled or replaced, be sure to perform the required adjustments in the order given below. (See Chapter 3 for details on the adjustments)
 1. First Dot adjustment
 2. PW Sensor adjustment
 3. Head Angle adjustment
 4. Bi-D Adjustment

2.3.24 Removing the PF Motor

□ Illustration

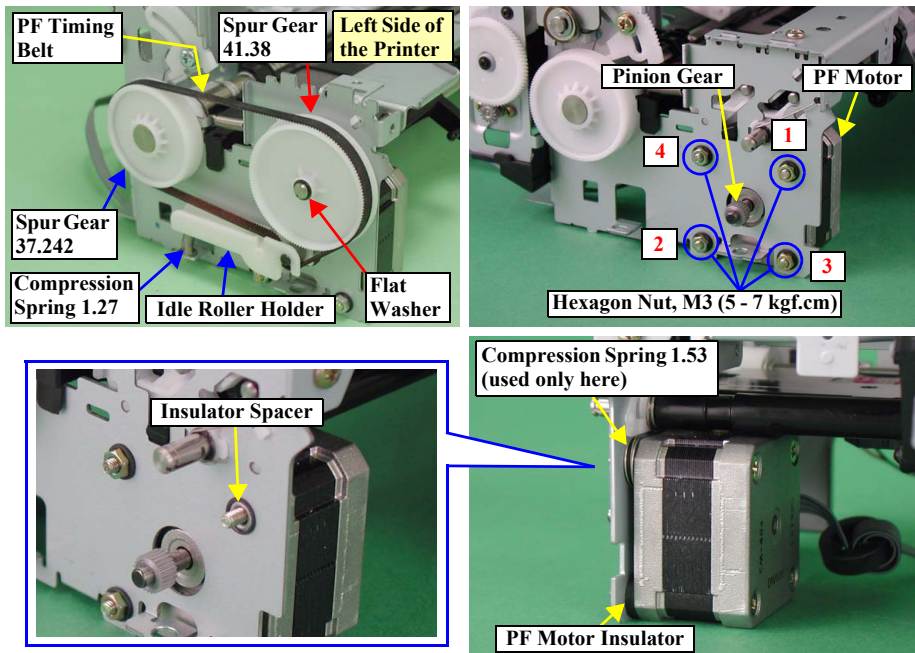



Figure 2-96. Removing the PF Motor

□ Parts/Components must be removed to remove the PF Motor.

Paper Support Assy., Left Housing, Right Housing, Panel Board Assy. (Panel Board and LCD Module), Upper Housing, Rear Housing, Main Board Assy., ASF Assy., Shaft Assy. Holder, Printer Mechanism

□ Disassembly Procedure

CAUTION  When performing the next step, be careful not to lose the Compression Spring 1.27 as it comes off when the tension of the Idle Roller Holder is reduced.

1. Release the PF Timing Belt from the Spur Gear 37.242 and the Spur Gear 41.38.
2. Remove the flat washer that secures the Spur Gear 41.38 and pull out the Spur Gear 41.38.
3. Remove the Compression Spring 1.27 and the Idle Roller Holder together with the Timing Belt.

CAUTION  Beware of the following items when performing the next step.

- Be careful not to damage the pinion gear of the PF Motor.
- Be careful not to lose the Compression Spring 1.53 as it may come off when the PF Motor is removed.

4. Remove the four nuts that secure the PF Motor and remove it.

REASSEMBLY  ■ Tighten the nuts to secure the PF Motor in the order shown in Figure 2-96.

- Make sure that there is no gap between the Insulator Spacer and the Main Frame.

2.3.25 Removing the PF Roller Assy.

□ Illustration

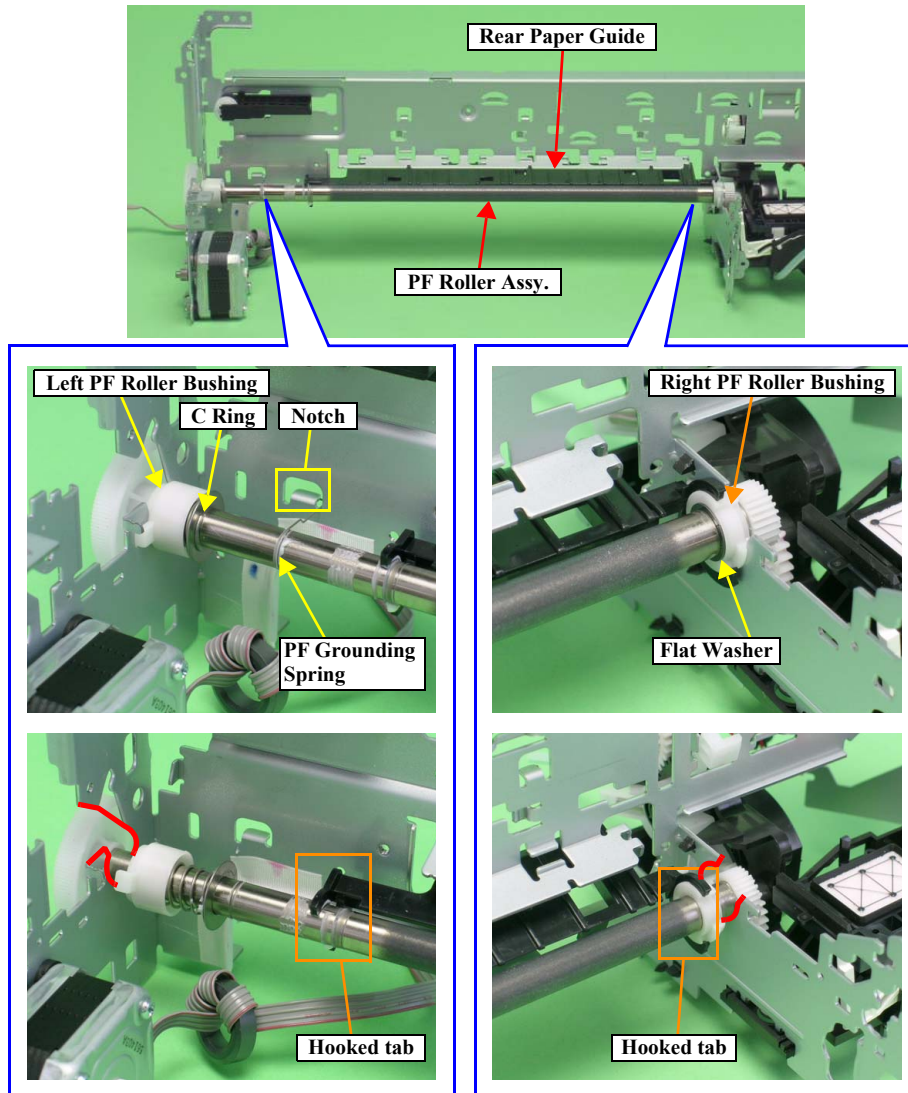

Figure 2-97. Removing the PF Roller Assy.

□ Parts/Components must be removed to remove the PF Roller Assy.

Paper Support Assy., Left Housing, Right Housing, Panel Board Assy. (Panel Board and LCD Module), Upper Housing, Rear Housing, Main Board Assy., ASF Assy., Shaft Assy. Holder, Printer Mechanism, APG Assy., Print Head, Carriage Unit, CD-R Guide Assy., Front Paper Guide, Upper Paper Guide

□ Disassembly Procedure

1. Remove the PF Grounding Spring from the notch (□) of the Main Frame with tweezers and then remove the spring from the PF Roller Assy.

CAUTION



When performing the next step, be careful not to touch or damage the coated part of the PF Roller Assy.

2. Pull out the C ring from the PF Roller Assy. leftward, and move the Left PF Roller Bushing inward.
3. Remove the flat washer from the right edge of the PF Roller Assy. and move the Right PF Roller Bushing inward.
4. Lift the PF Roller Assy. along with the notch of the Main Frame, then release the assy. from the two tabs (□) of the Rear Paper Guide, and remove the assy.

REASSEMBLY



- Reattaching the Rear Paper Guide which has become detached
 - Insert the both ends of the Torsion Spring 21.2 of the Rear Paper Guide into the holes (□) of the Main Frame.

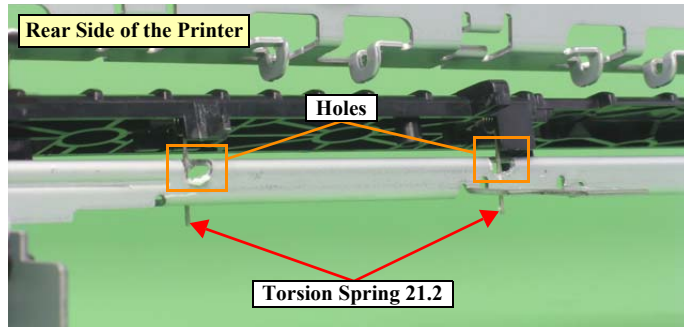

Figure 2-98. Reattaching the Rear Paper Guide

- Reinstalling the PF Roller Assy.
 - Set the guide pins of the Left/Right PF Roller Bushings into the positioning holes.

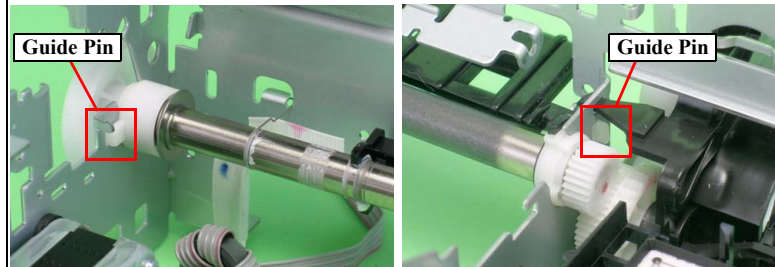

Figure 2-99. Reinstalling the Left/Right PF Roller Bushings

ADJUSTMENT
REQUIRED

- Whenever any one of the following parts are replaced, be sure to apply proper amount of the specified oil to them. (See Chapter 4 for details on the lubrication.)
 - PF Roller Assy.
 - PF Grounding Spring

CHAPTER

3

ADJUSTMENT

3.1 Adjustment Items and Overview

This chapter describes adjustments to be made after the disassembly/reassembly of this product.

3.1.1 Replacement Part-Based Adjustment Priorities

The following table shows the adjustment items and their order for the replacement parts.

Note: “Required” in this table indicates the adjustment items that must be implemented when the corresponding parts/units have been removed or replaced. “Recommended”, on the other hand, indicates those which are recommended the adjustment after removing or replacing them. “-” means the adjustment is not needed.
 When having removed or replaced more than one part/unit, refer to the items that correspond to the parts/units.

Table 3-1. Adjustment Item

Performance Priority	1	2	3	4	5	6	7	8	9	10	11	12
	EEPROM Data Copy	Market Setting	USB ID Input	Waste Ink Pad Counter	Ink Charge	Head ID Input	PG Adjustment	First dot Adjustment	PW Sensor Adjustment	Head Angular Adjustment	Bi-d Adjustment	Offset Input for CR Motor Calorific Limitation
ASF Assy. Removal	-	-	-	-	-	-	-	Required	-	-	-	-
ASF Assy. Replacement	-	-	-	-	-	-	-	Required	-	-	-	-
CR Motor Removal	-	-	-	-	-	-	-	Required	Required	Recommended	Required	-
CR Motor Replacement	-	-	-	-	-	-	-	Required	Required	Recommended	Required	Required
Upper Paper Guide Removal	-	-	-	-	-	-	-	-	-	-	-	-
Upper Paper Guide Replacement	-	-	-	-	-	-	-	-	-	-	-	-
EJ Frame Assy. Removal	-	-	-	-	-	-	-	-	-	-	-	-
EJ Frame Assy. Replacement	-	-	-	-	-	-	-	-	-	-	-	-
Carriage Unit Removal	-	-	-	-	-	-	Required	Required	Required	Recommended	Required	-
Carriage Unit Replacement	-	-	-	-	-	-	Required	Required	Required	Recommended	Required	-
Print Head Removal	-	-	-	-	-	-	Required	Required	Required	Required	Required	-
Print Head Replacement	-	-	-	-	Required	Required	Required	Required	Required	Required	Required	-
Main Board Assy. Removal	-	-	-	-	-	-	-	-	-	-	-	-
Main Board Assy. Replacement (Read OK)	Required	-	-	-	-	-	-	-	-	-	-	-
Main Board Assy. Replacement (Read NG)	-	Required	Required	Required (Replacing Waste Ink Pads)	-	Required	-	Required	Required	Required	Required	Required

Performance Priority	1	2	3	4	5	6	7	8	9	10	11	12
	EEPROM Data Copy	Market Setting	USB ID Input	Waste Ink Pad Counter	Ink Charge	Head ID Input	PG Adjustment	First dot Adjustment	PW Sensor Adjustment	Head Angular Adjustment	Bi-d Adjustment	Offset Input for CR Motor Calorific Limitation
Shaft Assy. Holder Removal	-	-	-	-	-	-	-	-	-	-	-	-
Shaft Assy. Holder Replacement	-	-	-	-	-	-	-	-	-	-	-	-
CR Guide Shaft Removal	-	-	-	-	-	-	Required	Required	Required	-	Required	-
CR Guide Shaft Replacement	-	-	-	-	-	-	Required	Required	Required	-	Required	Required
EJ Roller Assy. Removal	-	-	-	-	-	-	-	-	-	-	-	-
EJ Roller Assy. Replacement	-	-	-	-	-	-	-	-	-	-	-	-
Power Supply Assy. Removal	-	-	-	-	-	-	-	-	-	-	-	-
Power Supply Assy. Replacement	-	-	-	-	-	-	-	-	-	-	-	Required
Front Paper Guide Removal	-	-	-	-	-	-	-	Recommended	Recommended	Recommended	Required	-
Front Paper Guide Replacement	-	-	-	-	-	-	-	Recommended	Recommended	Recommended	Required	-
PF Motor Removal	-	-	-	-	-	-	-	-	-	-	-	-
PF Motor Replacement	-	-	-	-	-	-	-	-	-	-	-	-
Waste Ink Pads Removal	-	-	-	-	-	-	-	-	-	-	-	-
Waste Ink Pads Replacement	-	-	-	Required	-	-	-	-	-	-	-	-
PW Sensor Removal	-	-	-	-	-	-	-	-	Required	-	-	-
PW Sensor Replacement	-	-	-	-	-	-	-	-	Required	-	-	-
Printer Mechanism Removal *1)	-	-	-	-	-	-	Recommended	-	-	-	-	-
Printer Mechanism Replacement *1)	-	-	-	-	-	-	Recommended	-	-	-	-	-
Ink System Removal	-	-	-	-	-	-	-	-	-	-	-	-
Ink System Replacement	-	-	-	-	-	-	-	-	-	-	-	-

*1) The adjustment has been completed at the unit level of ASP supply. However, since “Main Board”, “Print Head” and “ASF” are supplied separately, refer to the each item that corresponds to the part/unit.

3.2 Adjustment by using adjustment program

The procedures of the adjustment items will be explained here. Servicing Adjustment Item List

The adjustment items of this product are as follows. For details of the adjustment items, refer to the detailed procedures and sketches of the adjustment items.

Table 3-2. Adjustment Items

	Function Item	Purpose	Method Outline	Used Media
Adjustment items	Market Setting	After replacing the Main Board, write the market setting information onto the new board.	After replacing the Main Board, write the market setting information onto the new board. Market ID, CSIC	Non-target
	USB ID Input	This adjustment is made to allow the PC to recognize the connected printers individually when multiple printers of the same model are connected and used with the PC via a USB hub.	Enter the serial numbers of the printers. The correction value is saved to the specific EEPROM address on the Main Board.	Non-target
	Head ID Input	At the time of Print Head replacement, this adjustment is made to correct head manufacturing variations and eliminate the individual differences of print quality.	Enter the ID of the Head QR code label applied to the Print Head to save it to the EEPROM on the Main Board. (Supplement: Read the QR code label from left to right on the top row and from top to bottom in due order.)	Non-target
	Head Angular Adjustment	This adjustment is made to correct the error in the Print Head mounting position (angle of the Print Head to the paper surface) to keep the nozzle intervals uniform in the CR main scanning direction.	Print the adjustment pattern. Check the displacement amount of the pattern. Print the exclusive pattern again and adjust the displacement amount.	Plain paper (A4)
	Bi-D Adjustment	This adjustment is made to correct the print timing in the go and return paths in bi-directional printing. (This printer carries out printing with PG (typ.) and PG (-))	Print the adjustment patterns to check the displacement amounts of the patterns. Select/enter the pattern number that has the smallest displacement amount in the program. Print the exclusive patterns again and adjust the displacement amount. The correction value is saved into the EEPROM.	Photo Quality Ink Jet Paper (A4)
	PW Sensor Adjustment	This adjustment is made to correct the mounting position of the PW Sensor on a software basis to minimize the paper detection error caused by the variations of the mounting position.	Print the adjustment patterns. Select the pattern number 5mm away from each edge, and enter that number in the program. The correction value is saved to the specific EEPROM address on the Main Board.	Plain paper (A4)

Table 3-2. Adjustment Items

	Function Item	Purpose	Method Outline	Used Media
Adjustment items	First Dot Adjustment	This adjustment is made to correct the First Dot Position in the CR main scanning direction.	Enter the correction value in the program using the rule position of the print pattern as a reference. The correction value is saved to the specific EEPROM address on the Main Board.	Plain paper (A4)
	Top Margin Adjustment	This adjustment is made to correct the top margin.	Enter the correction value in the program using the rule position of the print pattern as a reference. The correction value is saved to the specific EEPROM address on the Main Board.	Plain paper (A4)
	Offset Input for CR Motor Calorific Limitation	When the Main Board, CR Motor or PSB/PSE Board is changed individually, this adjustment is made to write the maximum offset to prevent the occurrence of damage to the motor at the time of CR Motor heat generation. However, when the CR Guide Shaft is changed together with the above part, this adjustment is made to measure the manufacturing variations of the CR Motor and PSB/PSE Board, utilize the motor capability to the maximum for motor heat generation control, and prevent the motor from being damaged by CR Motor heat generation.	Selecting this function saves the offset into the EEPROM.	Non-target

Table 3-3. Maintenance Functions

Function Item		Purpose	Adjustment Outline	Used Media
Maintenance items	Head Cleaning	This function is used to execute Cleaning efficiently when ink is not delivered from the Head properly, e.g. dot missing or skewed injection. This function is used together with the Nozzle Check Pattern to confirm the Cleaning effects.	Select this function to perform a power cleaning.	Non-target
	Ink Charge	This must be carried out after replacing the Print Head to full fill the ink path inside the new Print Head with ink (make the all nozzles ready for print) by ejecting the liquid preset in the ASP Print Head.	Select this function to execute the ink sucking operation equivalent to the Initial Charge.	Non-target
	Check/Reset Protection Counter	Check the current protection counter and reset the counter when it has reached or come close to the upper limit. The Waste Ink Pad must be replaced when the counter is cleared.	Select this function to read/display the current data from the specific EEPROM address on the Main Board, and check whether the current counter value is close to the upper limit or not. For the reset function, select this function in the exclusive servicing program after Waste Ink Pad replacement, and reset the corresponding data at the specific address in the EEPROM on the Main Board.	Non-target
	EEPROM Data Copy	This function is used to read the above necessary information from the EEPROM of the faulty Main Board using the D4 function to reduce the auxiliary adjustment items at the time of Board replacement.	Select this function to read the data from the faulty board. After that, change the Main Board and then write the read data to a new board.	Non-target

Table 3-4. Check Pattern Printing

Function Item		Purpose	Adjustment Outline	Used Media
Check pattern items	A4 Normal Paper Print	This pattern is used to check whether adjustment results are normal.	Select this function to print the print patterns, and check the adjustment result in each pattern.	Plain paper (A4)
	A4 Photo Quality Ink Jet Paper Print	This pattern is used to check whether adjustment results are normal.	Select this function to print the print patterns, and check the adjustment result in each pattern.	Photo Quality Ink Jet Paper (A4)
	A4 Photo Paper/ Glossy Photo Paper Print	This pattern is used to check whether adjustment results are normal.	Select this function to print the print patterns, and check the adjustment result in each pattern.	Glossy Photo Paper (A4)
	CD-R Print	Check if the center position of CDR is correct.	Print the print patterns and check the patterns for any displacement.	Dummy CD Sheet
	Nozzle Check Pattern Print	This pattern is used to check simply whether all nozzles deliver ink or not.	Print the print patterns and check the patterns for any displacement.	Plain paper (A4)

Table 3-5. Appendix

	Function Item	Purpose	Adjustment Outline	Used Media
Appendix items	Save All EEPROM Data	This function is used to analyze defective products.	Save the data of all EEPROM addresses.	Non-target
	Paper Feed Test	Paper feeding/ejecting operations can be checked by this function.	Specify the number of sheets to be fed and check the paper feeding operation.	Non-target
	Reset EEPROM	Returns the all settings stored in the EEPROM to their default. This can be used when failed to copy the data in the EEPROM.	Returns the all settings stored in the EEPROM to their default.	Non-target
	APG Check	This function is used to check if APG Assy. works properly.	Check the CR Guide Shaft movement.	Non-target

3.2.1 How to judge print samples by using the adjustment program

This section explains how to judge print samples by using the adjustment program. Follow the instructions of the adjustment program for details of the adjustment methods.

3.2.1.1 Head Angular Adjustment

The adjustment pattern is printed as shown below.

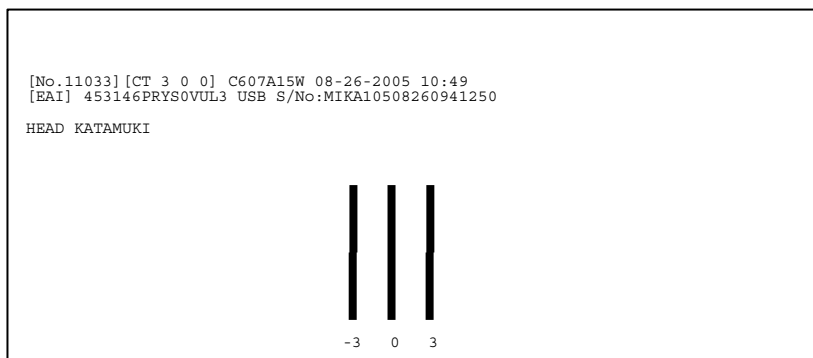
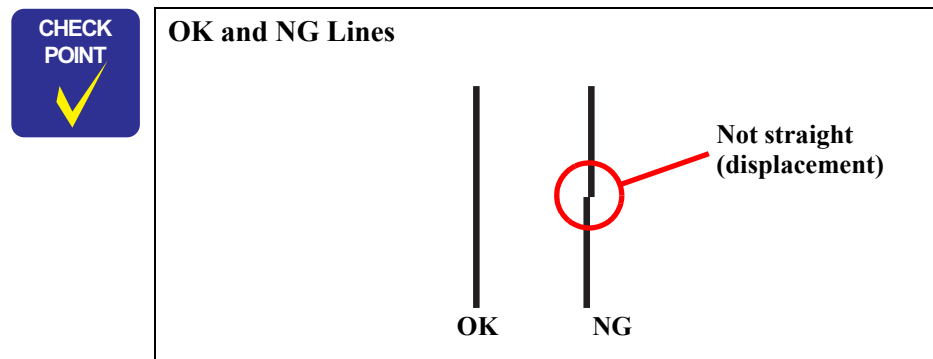

Figure 3-1. Head Angular Adjustment Pattern

- Selecting the best pattern
Select the straightest line among the -3 to +3 lines and enter the value of the selected line.
- Supplement
If all the printed lines are straight and hard to select, reassemble or replace the Print Head and print the pattern again.



3.2.1.2 Bi-d Adjustment

The adjustment pattern is printed as shown below.

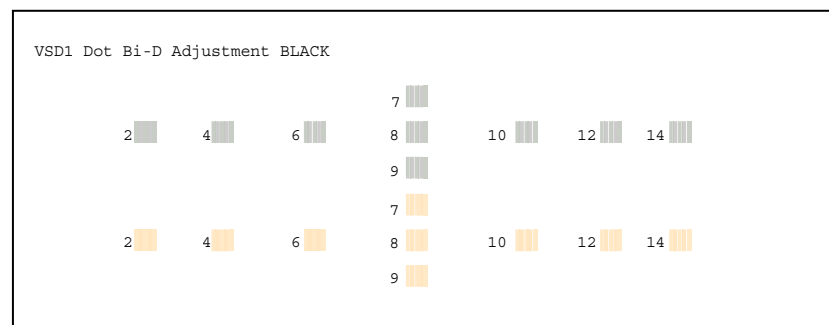
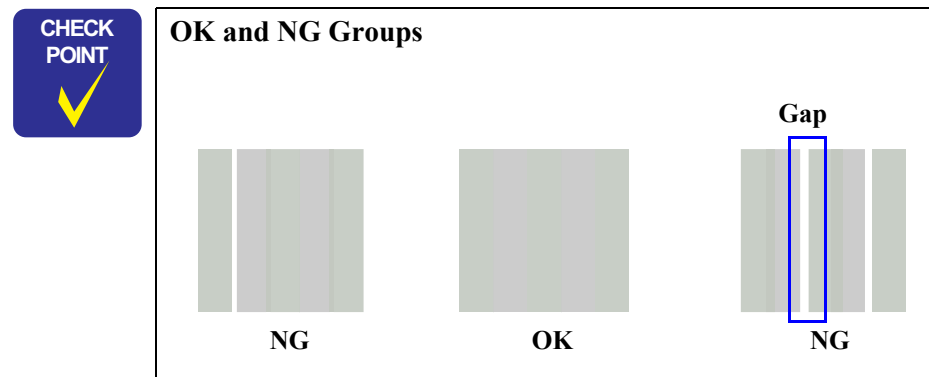

Figure 3-2. Bi-D Adjustment Pattern (PG typ.: VSD1)

- Selecting the best pattern
Examine the printout patterns for each of the seven modes, and select the value for the group of most neatly aligned blocks (without overlapping or gap between the blocks) for each mode.
 - PG typ.: VSD1/VSD2/VSD3/ECO
 - PG -: VSD1/VSD2/VSD3
- Supplement
If none of the groups completely aligned, select the value for the most closely aligned group for each mode, and print the patterns again.



3.2.1.3 PW Sensor Adjustment/First Dot Adjustment/Top Margin Adjustment

The adjustment pattern is printed as shown below.

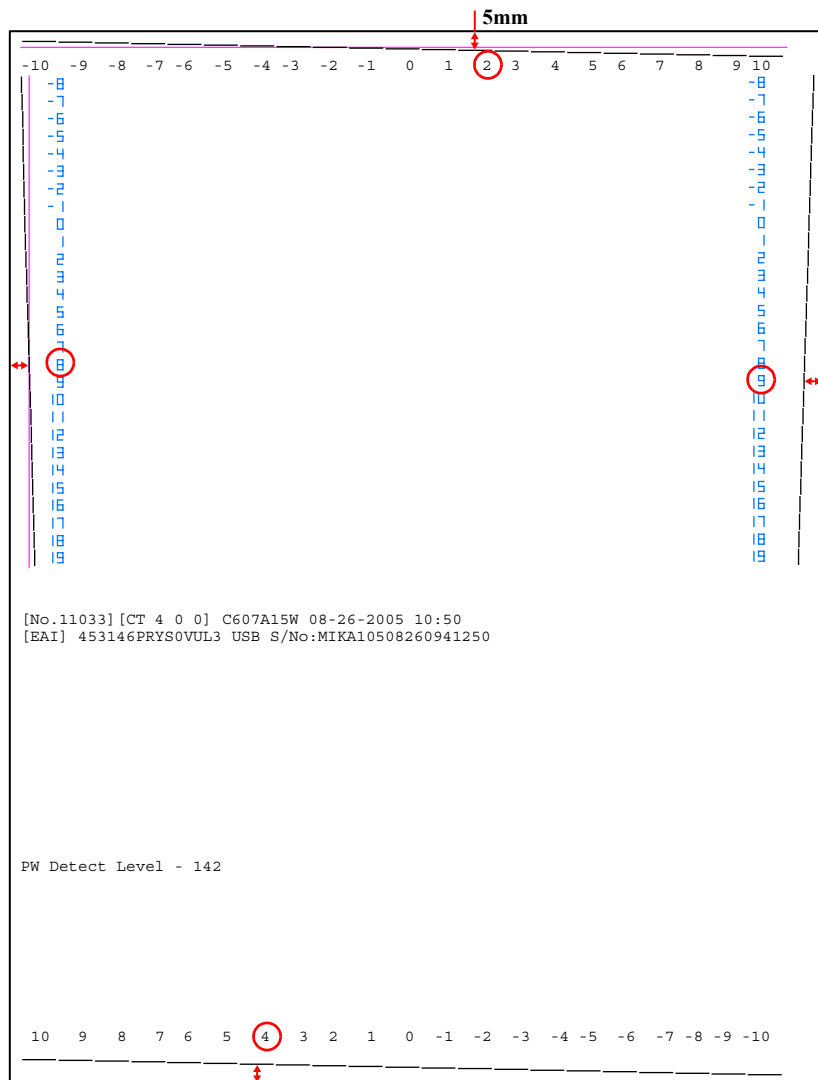

Figure 3-3. PW Sensor Adjustment/First Dot Adjustment/Top Margin Adjustment Patterns

PW Sensor Adjustment

- Selecting the best pattern
Select the value beside the line located 5 mm away from the edge of the paper for each of the left, right, top and bottom margins.

Example) For the pattern shown left, select “2” for top, “4” for bottom, “8” for left, and “9” for right.

First Dot Adjustment

- Selecting the best pattern
Select the value for the most neatly overlapped black (PW) and magenta (First Dot) lines on the left side of the printout.

Example) For the pattern shown below, the black and magenta lines are completely overlapped each other beside “8”, so select “8”.

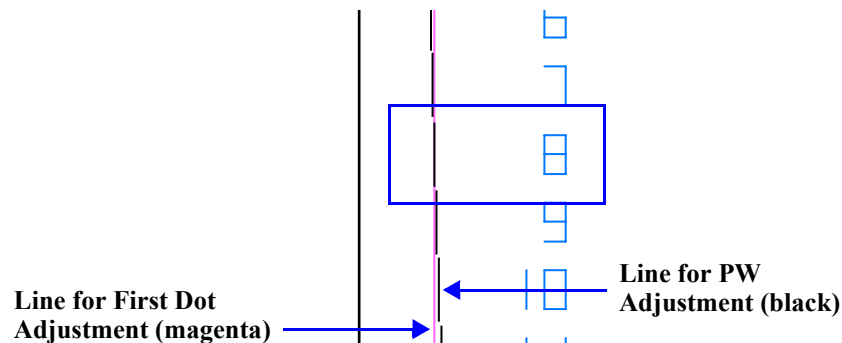

Figure 3-4. Closeup of the Adjustment Pattern (left side of printout)

Top Margin Adjustment

- Selecting the best pattern
Select the value for the most neatly overlapped black (PW) and magenta (top margin) lines on the top side of the printout.

Example) For the pattern shown below, the black and magenta lines are completely overlapped each other beside “-2”, so select “-2”.

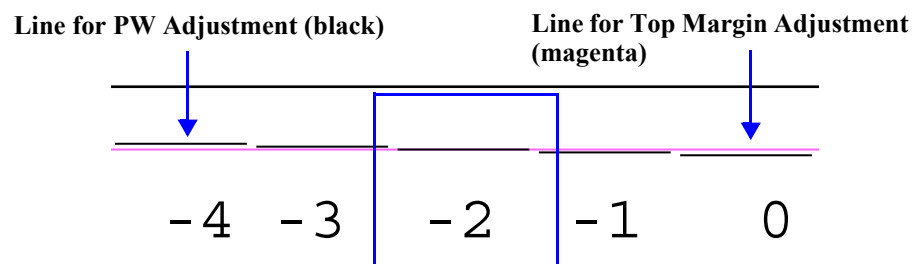

Figure 3-5. Closeup of the Adjustment Pattern (top side of printout)

3.3 Adjustment Except Adjustment Program

Following is adjustment except Adjustment Program.

3.3.1 PG Adjustment

[Purpose]

This adjustment is required when removing or replacing the following parts/units in order to secure the specified space between the print-side of the Print Head and the paper.

- Carriage Unit
- CR Guide Shaft
- Left (Right) Parallel Adjust Bushing
(Including when having moved the Left (Right) Parallel Adjust Bushing)

[Adjustment Procedure]

1. Make both sides of the two Thickness Gauge (1.30mm and 1.46mm) clean by wiping with Bemcot with a little alcohol.
2. To make the PG position minus (-), turn the gear of the APG Assy. and match the flag centre of the Right CR Cam with the PG Sensor.

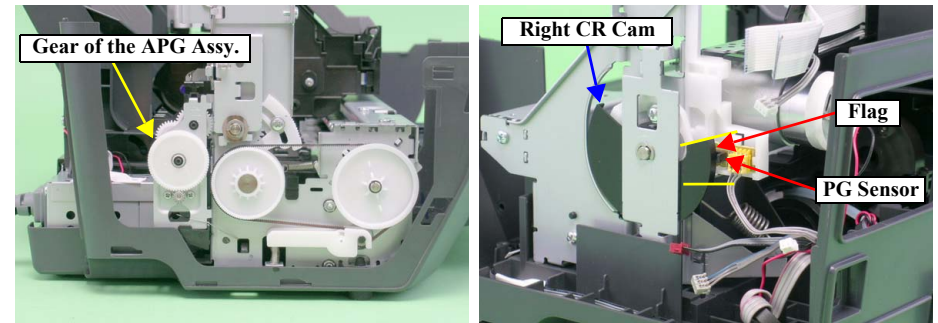

Figure 3-6. Setting PG Position

3. Match the 0 position (Hole point of gear) of the Left (Right) Parallel Adjust Bushing with the rib of the Main Frame.

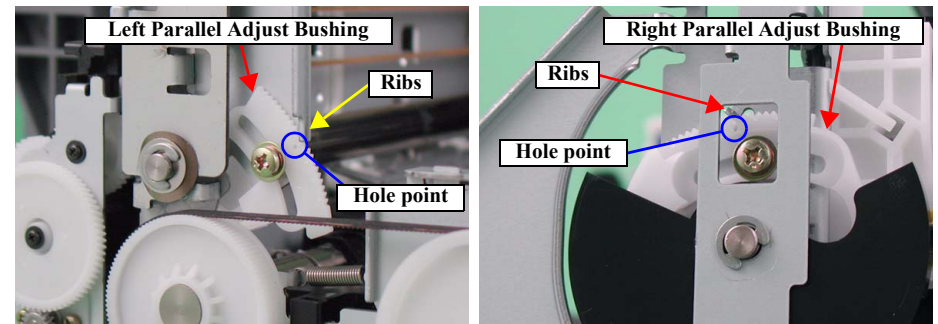

Figure 3-7. Setting Parallel Adjust Bushing

4. Move the Carriage Unit to the centre of the printer and remove the Cartridge Lever. Then, set the PG-Adjustment Dummy Cartridge.

5. Move the Carriage Unit to the left edge of the printer, then set the Thickness Gauge (1.30mm) on the left ribs (x3) of the Front Paper Guide.

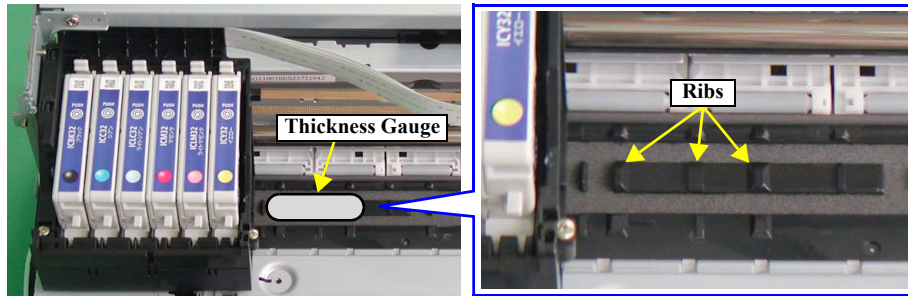

Figure 3-8. Setting Thickness Gauge

7. Remove the Thickness Gauge and move the Carriage Unit to the right edge. Then, set the Thickness Gauge on the right ribs (x3) of the Front Paper Guide.

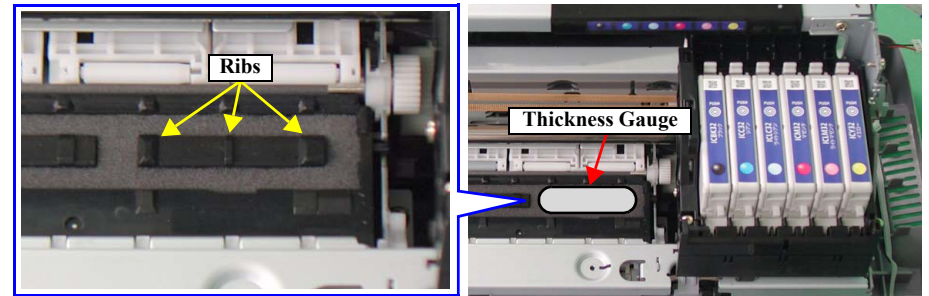

Figure 3-10. Setting Thickness Gauge

6. Implement PG Adjustment on the left according to the flowchart in the Figure 3-9.

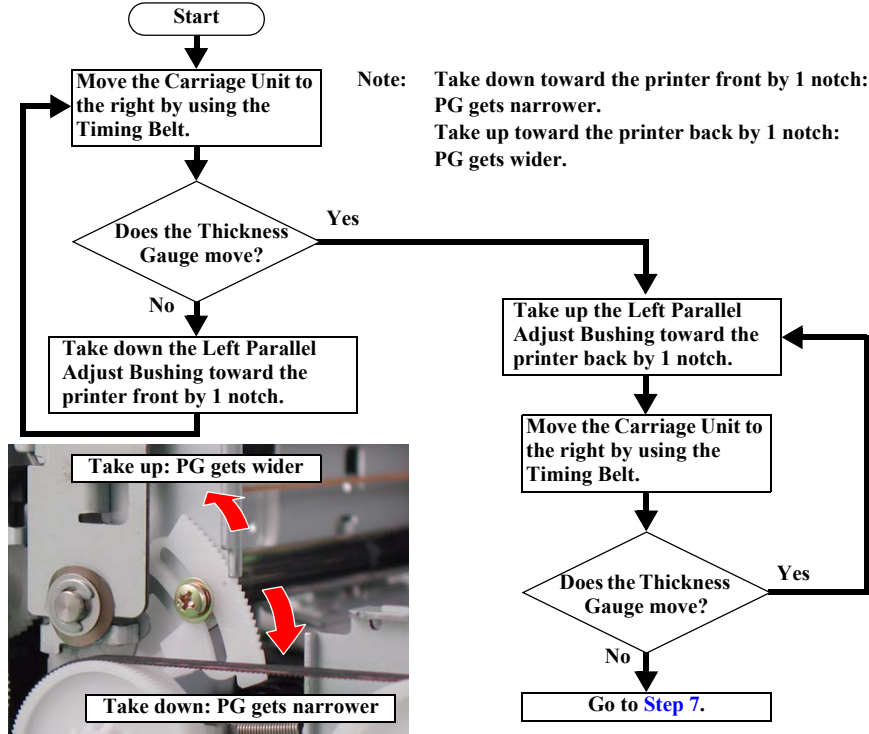

Figure 3-9. PG Adjustment (Left Side)

8. Implement PG Adjustment on the right according to the flowchart in the Figure 3-11.

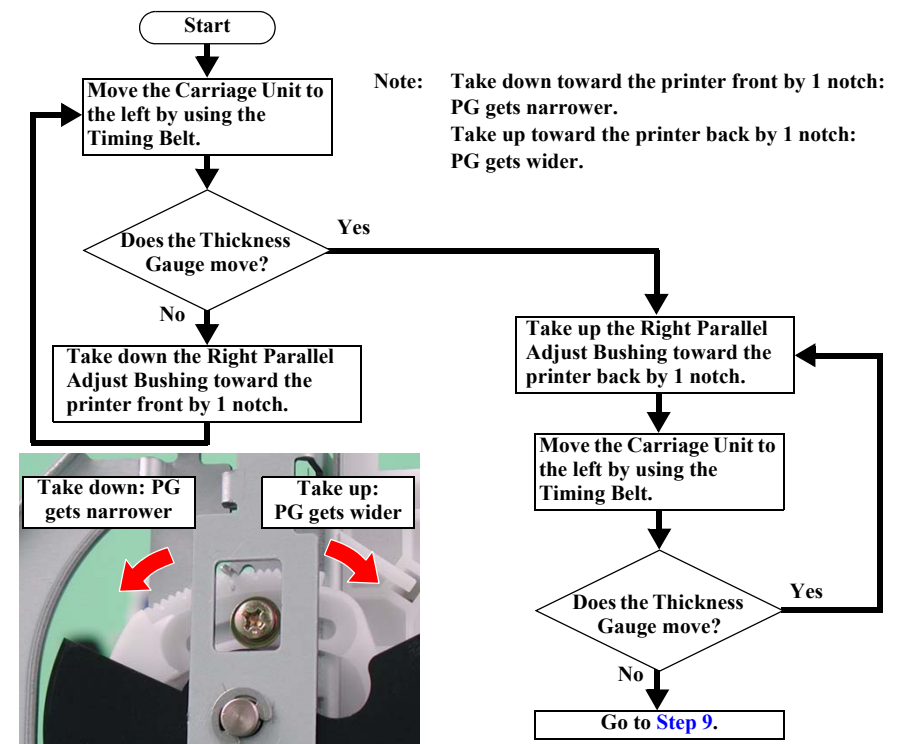

Figure 3-11. PG Adjustment (Right Side)

9. After finishing PG Adjustment on the right, move the Carriage Unit to the left edge again, then check PG according to the flowchart in the [Figure 3-12](#).

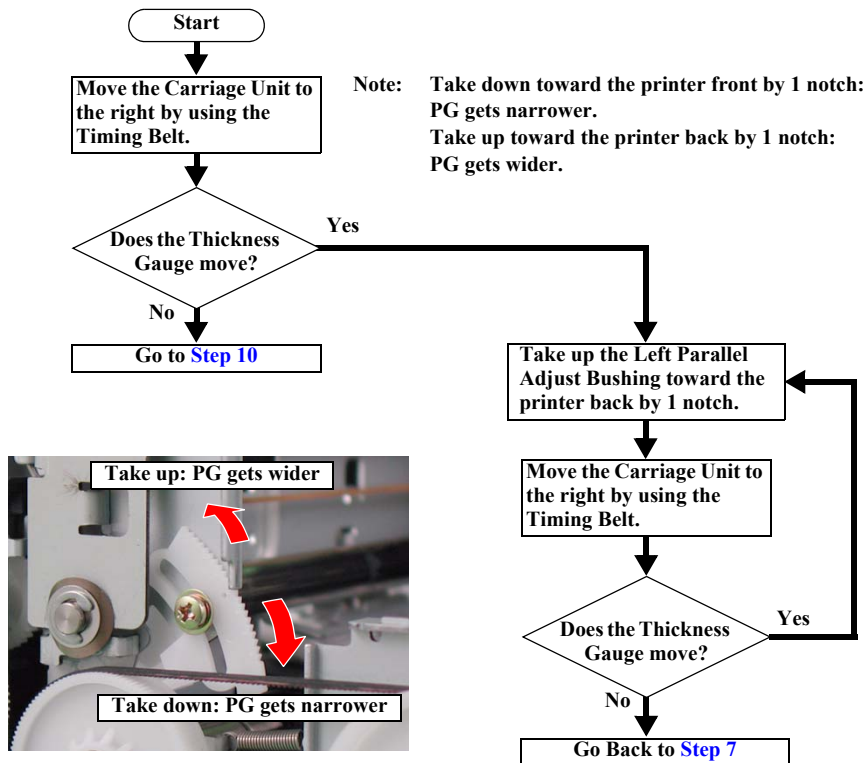

Figure 3-12. PG Checking (1)

10. Move the Carriage Unit back to the left edge of the printer, then set the Thickness Gauge (1.46mm) on the ribs (x3) of the Front Paper Guide in the same way as the [Figure 3-8](#).

11. Check PGs on both the left and right according to the flowchart in the [Figure 3-13](#).

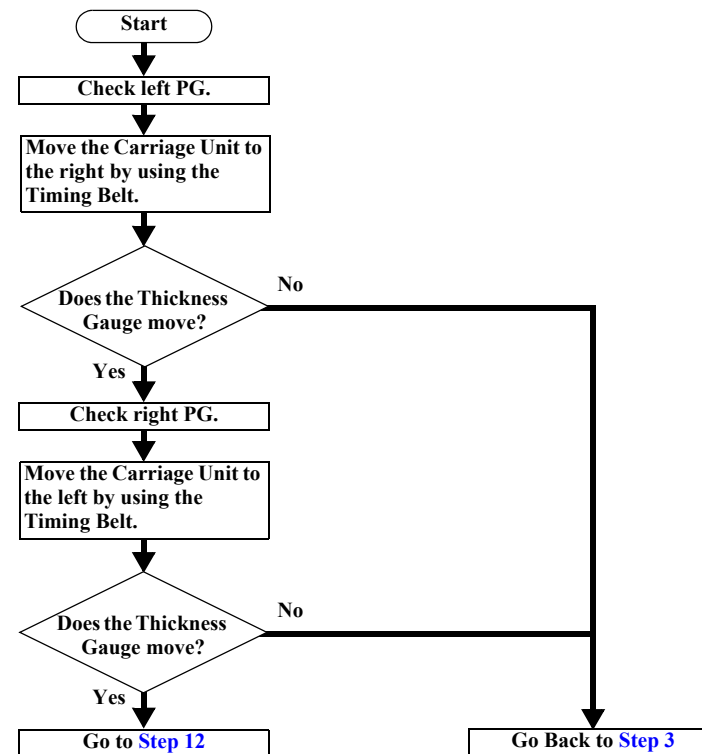

Figure 3-13. PG Checking (2)

12. After finishing the adjustment, screw the Left (Right) Parallel Adjust Bushing.
13. After screwing, check PGs on both the left and right again according to the flowchart in the [Figure 3-13](#).

CHAPTER

4

MAINTENANCE

4.1 Overview

This section provides information to maintain the printer in its optimum condition.

4.1.1 Cleaning

This printer has no mechanical components which require regular cleaning except the Print Head. When servicing, check the following parts and perform appropriate cleaning if stain is noticeable.



- **Never use chemical solvents, such as thinner, benzine, and acetone to clean the exterior parts of the printer like the housing. These chemicals may deform the components of the printer or deteriorate the quality of the printer.**
- **Be careful not to damage any components when you clean inside the printer.**
- **Do not scratch the surface of the PF Roller. Use a soft brush to wipe off dust. Use a soft cloth moistened with alcohol to remove ink stain.**
- **When using compressed air products; such as air duster, for cleaning during repair and maintenance, the use of such products containing flammable gas is prohibited.**

- Housing
Use a clean soft cloth moistened with water and wipe off any dirt. If the Housings are stained with ink, use a cloth moistened with neutral detergent to wipe it off.
- Inside the printer
Use a vacuum cleaner to remove any paper dust.
- LD Roller
When the paper loading function does not operate because friction of the LD Roller has gone down due to paper dust, remove the dust by using a soft brush or soft cloth moistened with alcohol.

4.1.2 Service Maintenance

If print irregularity (missing dot, white line, etc.) has occurred or the printer indicates “Maintenance Error”, take the following actions to clear the error.

Head Cleaning

If dot missing or banding phenomenon has occurred, use the Head Cleaning function and perform the Print Head cleaning operation.* This function can be performed by operating the control panel, the printer driver utility and the Adjustment Program.

* This product has three modes for Manual Cleaning, and it automatically selects the best cleaning mode in accordance with the various conditions and performs the operation. Therefore, the consumption of the ink by the manual cleaning will vary according to the selected mode for the condition.

Maintenance Error

This error appears when the protection counter (for the Waste Ink Pad) reaches the upper limit (limit of the Waste Ink Pad). The Waste Ink Pad is used to absorb the waste ink produced by printing, cleaning and flushing. The amount of the waste ink is counted in the EEPROM to cause the error to prevent the Waste Ink Pad from overflow. The counter value fluctuates depending on the frequency of use as this model calculates the loss of waste ink by evaporation to reflect the amount to the counter.

**Service required.
Parts inside your printer are at the end
of their service life.
See your manual for details.**

Figure 4-1. Maintenance Error Displayed on the LCD

When the maintenance error occurs, replace the Waste Ink Pad with a new one and reset the protection counter using the Adjustment Program.

If you find the counter is close to its limit, replace the Waste Ink Pad and reset the counter to save the user from having to send the printer for repair again due to the maintenance error.

4.1.3 Lubrication

The lubrication used for the components of Stylus Photo R340/350 has been decided on based on evaluation carried out by Epson. As a result, the specified amount of lubricant should be applied in the places specified when carrying out repair and maintenance work.

- When wiping off the grease during the cleaning
- If necessary when performing assembly/disassembly of the printer



■ Never use oil or grease other than those specified in this manual. Use of different types of oil or grease may damage the components or affect the printer functions.

■ Never apply a larger amount of oil or grease than specified in this manual.

Table 4-1. Oil Applied to Stylus Photo R340/350

Type	Name	EPSON Code	Supplier
Grease	G-26	1080614	EPSON
	G-63	1218320	
	G-74	1409257	



When using G-74, it is recommended to use a flux dispenser (1049533) together.

☐ Refer to the following figures for the lubrication points.

<Lubrication Point>
Point on the right side of the Hopper as shown in the figure

<Lubrication Type>
G-74

<Lubrication Amount>
Adequate dose

<Remarks>

- Use a flux dispenser to apply it
- Be careful not to apply too much.

<Lubrication Point>
Two points on the Hopper shown in the left figure.

<Lubrication Type>
G-74

<Lubrication Amount>
Adequate dose

<Remarks>
Use a flux dispenser to apply it

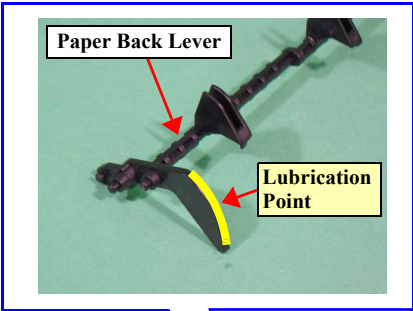
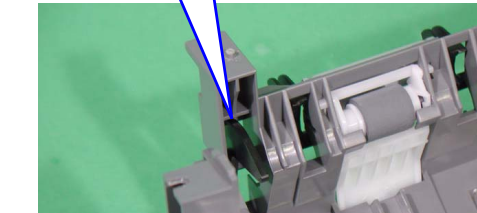
 <p>Paper Back Lever</p> <p>Lubrication Point</p>	<p><Lubrication Point> Point shown in the figure of the Paper Back Lever set in the ASF Assy.</p>
	<p><Lubrication Type> G-74</p>
<p><Lubrication Amount> Adequate dose</p>	
<p><Remarks> Use a flux dispenser</p>	

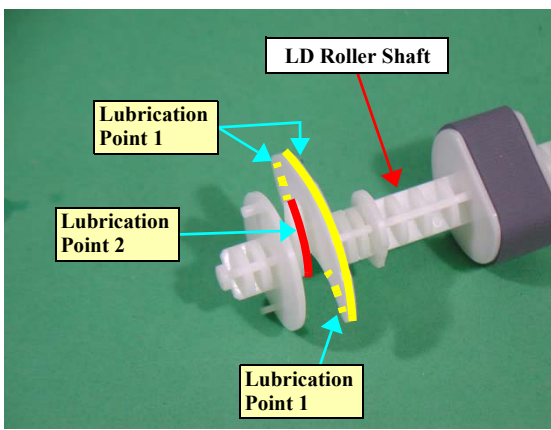
 <p>LD Roller Shaft</p> <p>Lubrication Point 1</p> <p>Lubrication Point 2</p> <p>Lubrication Point 1</p>	<p><Lubrication Point> 1. Cam of the LD Roller Shaft shown in the figure 2. Contact point between cam of the LD Roller Shaft and the Paper Back Lever</p>
<p><Lubrication Type> 1. G-74 2. G-74</p>	
<p><Lubrication Amount> Adequate dose</p>	
<p><Remarks> Use a flux dispenser to apply it</p>	

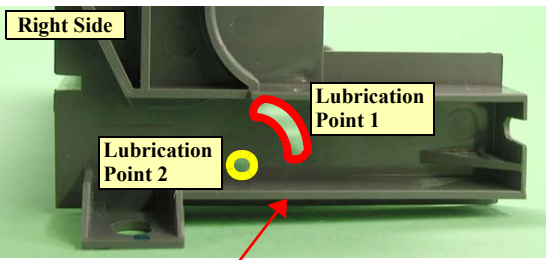
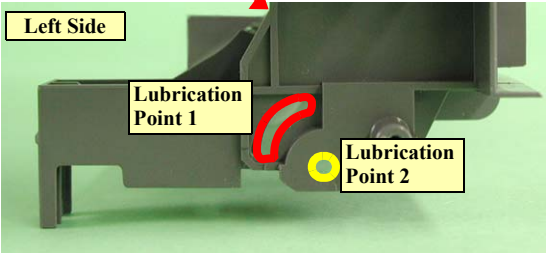
 <p>Right Side</p> <p>Lubrication Point 1</p> <p>Lubrication Point 2</p> <p>ASF Frame</p>	<p><Lubrication Point> 1. Point shown in the figure left. 2. Contacted site of the Paper Back Lever with the dowel.</p>
 <p>Left Side</p> <p>Lubrication Point 1</p> <p>Lubrication Point 2</p>	<p><Lubrication Type> 1. G-74 2. G-74</p>
<p><Lubrication Amount> Adequate dose</p>	
<p><Remarks> Use a flux dispenser</p>	

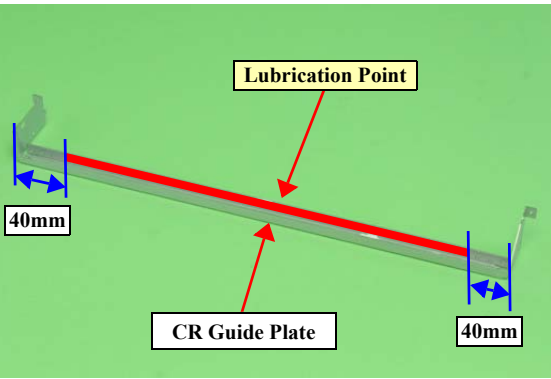
 <p>Lubrication Point</p> <p>CR Guide Plate</p> <p>40mm</p> <p>40mm</p>	<p><Lubrication Point> Inside surface of the CR Guide Plate</p>
<p><Lubrication Type> G-26</p>	
<p><Lubrication Amount> Enough to apply a thin layer of oil to the area shown by the red line in the left figure.</p>	
<p><Remarks> Use a syringe to apply it</p>	

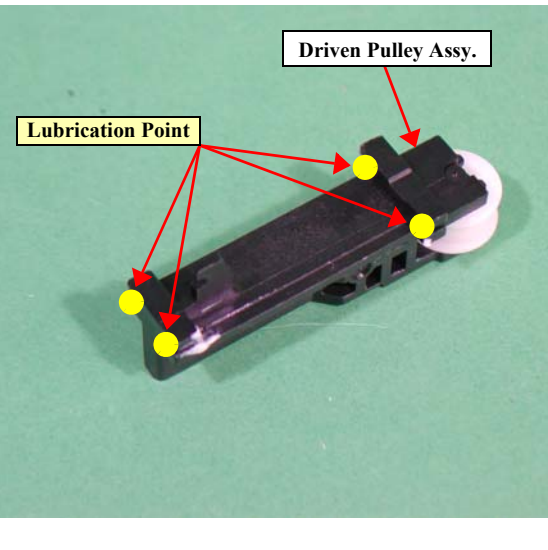
 <p>Driven Pulley Assy.</p> <p>Lubrication Point</p>	<p><Lubrication Point> The Driven Pulley Assy.</p> <p><Lubrication Type> G-26</p> <p><Lubrication Amount> 1mm x 4 points</p> <p><Remarks> Use a syringe. (both metallic and plastic needles are OK.)</p>
---	--

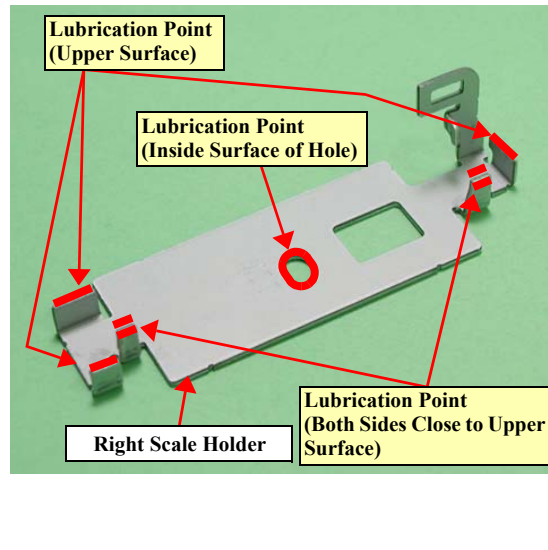
 <p>Lubrication Point (Upper Surface)</p> <p>Lubrication Point (Inside Surface of Hole)</p> <p>Right Scale Holder</p> <p>Lubrication Point (Both Sides Close to Upper Surface)</p>	<p><Lubrication Point> Specified points on the Right Scale Holder in the figure on the left</p> <p><Lubrication Type> G-63</p> <p><Lubrication Amount> 8 points (Adequate dose)</p> <p><Remarks> Use a brush to apply it</p>
---	--

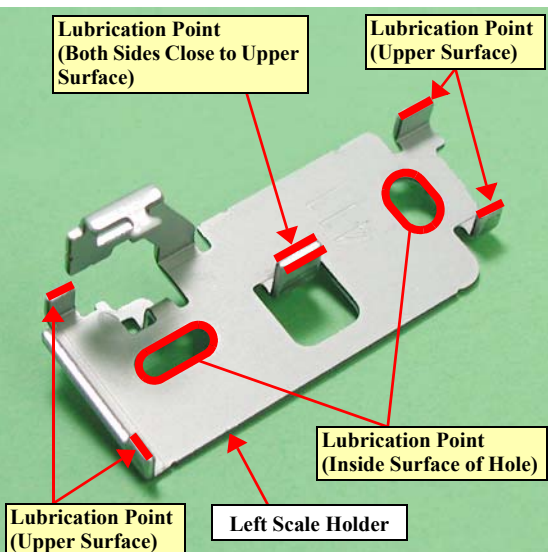
 <p>Lubrication Point (Both Sides Close to Upper Surface)</p> <p>Lubrication Point (Upper Surface)</p> <p>Lubrication Point (Upper Surface)</p> <p>Lubrication Point (Upper Surface)</p> <p>Lubrication Point (Upper Surface)</p> <p>Lubrication Point (Inside Surface of Hole)</p> <p>Lubrication Point (Upper Surface)</p> <p>Left Scale Holder</p>	<p><Lubrication Point> Specified points on the Left Scale Holder in the figure on the left</p> <p><Lubrication Type> G-63</p> <p><Lubrication Amount> 8 points (Adequate dose)</p> <p><Remarks> Use a brush to apply it</p>
---	---

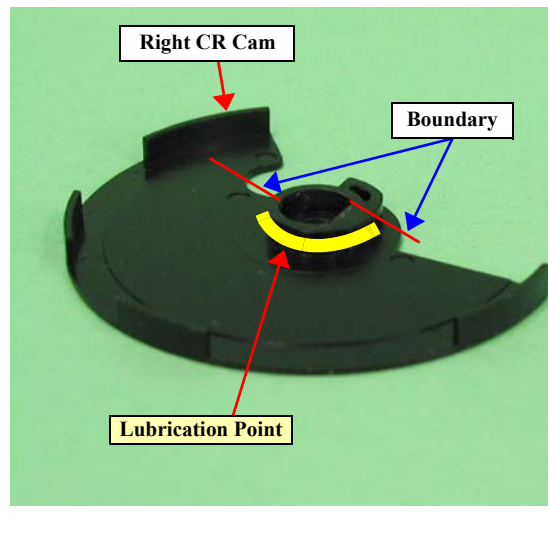
 <p>Right CR Cam</p> <p>Boundary</p> <p>Lubrication Point</p>	<p><Lubrication Point> Inside periphery surface of the Right CR Cam</p> <p><Lubrication Type> G-63</p> <p><Lubrication Amount> 4 points (Adequate dose)</p> <p><Remarks></p> <ul style="list-style-type: none"> • Use a brush to apply it • Do not apply it outside the boundary in the figure
--	--

	<p><Lubrication Point></p> <ol style="list-style-type: none"> 1. Surface of contact point between upper side of the Left CR Cam and the Main Frame 2. Surface of contact point between periphery surface of the Left CR Cam and the Left Parallel Adjust Bushing <p><Lubrication Type></p> <ol style="list-style-type: none"> 1. G-63 2. G-63 <p><Lubrication Amount></p> <ol style="list-style-type: none"> 1. Half periphery 2. Half periphery <p><Remarks></p> <p>Use a brush to apply it</p>
--	--

	<p><Lubrication Point></p> <p>Contact point between left side of the CR Guide Shaft and the Main Frame</p> <p><Lubrication Type></p> <p>G-63</p> <p><Lubrication Amount></p> <p>1mm x 3mm x 2 points</p> <p><Remarks></p> <p>Use a syringe with a plastic needle to apply it.</p>
--	---

	<p><Lubrication Point></p> <ol style="list-style-type: none"> 1. Groove on the right side of the CR Guide Shaft (Groove for the CR Shaft Right Fixed Spring) 2. Contact point between right side of the CR Guide Shaft and the Main Frame <p><Lubrication Type></p> <ol style="list-style-type: none"> 1. G-63 2. G-63 <p><Lubrication Amount></p> <ol style="list-style-type: none"> 1. Half periphery 2. 1mm x 3mm x 2 points <p><Remarks></p> <p>Use a syringe to apply it</p>
--	---

	<p><Lubrication Point></p> <p>Contact point between left side of the CR Guide Shaft and the CR Shaft Left Fixed Spring</p> <p><Lubrication Type></p> <p>G-63</p> <p><Lubrication Amount></p> <p>1mm x 3mm</p> <p><Remarks></p> <p>Use a syringe with a plastic needle to apply it.</p>
--	--

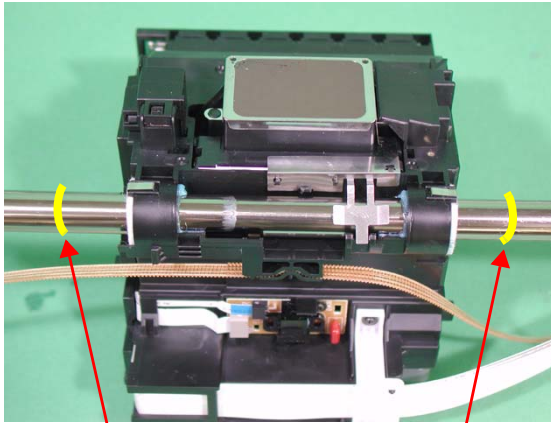
	<p><Lubrication Point> The CR Guide Shaft outside the bearing of the Carriage</p>
	<p><Lubrication Type> G-63</p>
	<p><Lubrication Amount> 120mg-160mg x 2 points</p>
<p style="text-align: center;">Lubrication Point</p>	<p><Remarks></p> <ul style="list-style-type: none"> • Use a air dispenser to apply it • Apply grease while rotating “CR Guide Shaft”

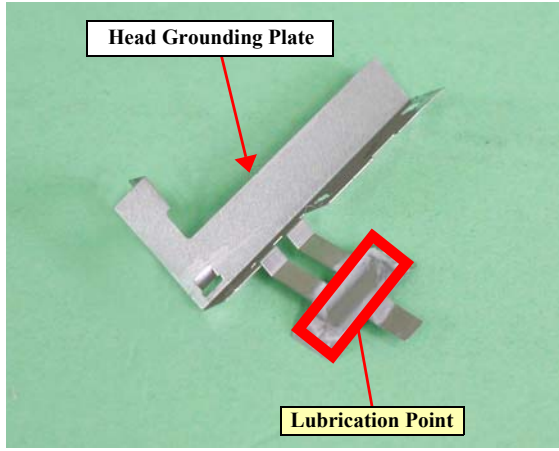
	<p><Lubrication Point> Contact point between the Head Grounding Plate and the Carriage</p>
	<p><Lubrication Type> G-63</p>
	<p><Lubrication Amount> Adequate dose</p>
	<p><Remarks> Use a cotton-tipped swab to apply it</p>

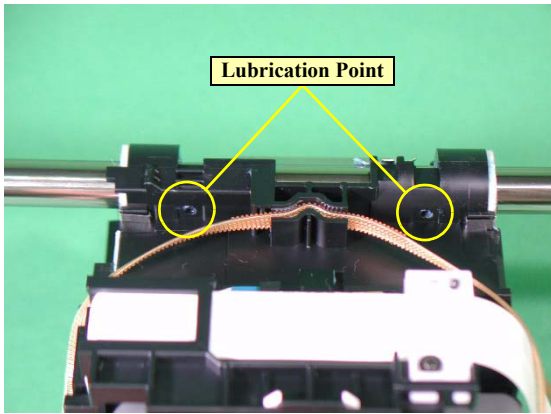
	<p><Lubrication Point> Holes inside the Carriage</p>
	<p><Lubrication Type> G-63</p>
	<p><Lubrication Amount> 150mg-210mg x 2 points</p>
	<p><Remarks> Use a air dispenser to apply it</p>

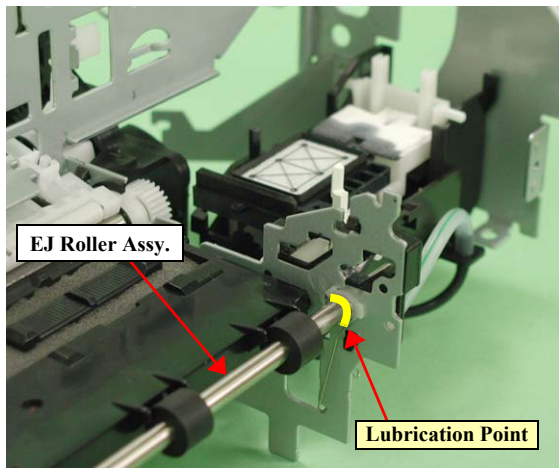
	<p><Lubrication Point> Contact point between the EJ Roller Assy. and the Right EJ Grounding Spring</p>
	<p><Lubrication Type> G-26</p>
	<p><Lubrication Amount> 1mm x 5mm</p>
<p style="text-align: center;">Lubrication Point</p>	<p><Remarks> Use a syringe with a metallic needle to apply it.</p>

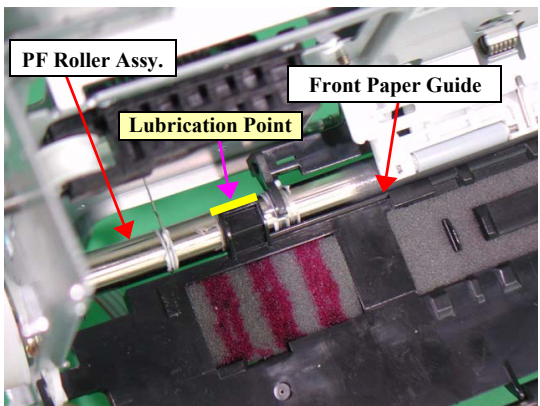
 <p>PF Roller Assy.</p> <p>Front Paper Guide</p> <p>Lubrication Point</p>	<p><Lubrication Point> Back of contact point between the PF Roller Assy. and hook of the Front Paper Guide</p> <p><Lubrication Type> G-26</p> <p><Lubrication Amount> 1mm x 10mm</p> <p><Remarks> Use a syringe with a metallic needle to apply it.</p>
--	---

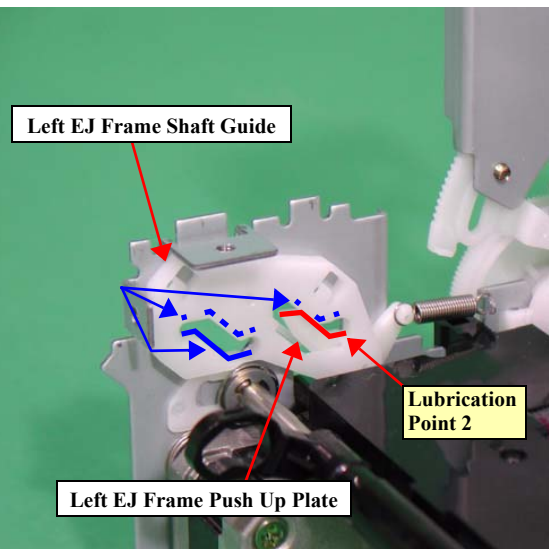
 <p>Left EJ Frame Shaft Guide</p> <p>Lubrication Point 2</p> <p>Left EJ Frame Push Up Plate</p>	<p><Lubrication Point></p> <ol style="list-style-type: none"> Contact point between the EJ Frame and its shaft inside the Left EJ Frame Shaft Guide Contact point between the EJ Frame and its shaft on upper surface of the Left EJ Frame Push Up Plate <p><Lubrication Type></p> <ol style="list-style-type: none"> G-26 G-26 <p><Lubrication Amount></p> <ol style="list-style-type: none"> 3 points (Adequate dose) 1 point (Adequate dose) <p><Remarks> Use a brush to apply it</p>
--	--

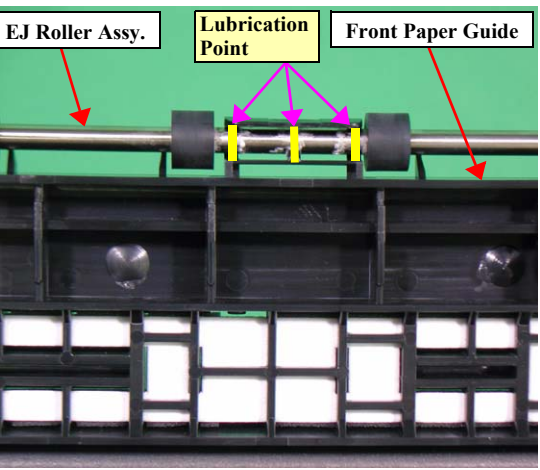
 <p>EJ Roller Assy.</p> <p>Lubrication Point</p> <p>Front Paper Guide</p>	<p><Lubrication Point> Bottom of contact point between the EJ Roller Assy. and hook of the Front Paper Guide</p> <p><Lubrication Type> G-26</p> <p><Lubrication Amount> Approx. 3mm-length x 3 points</p> <p><Remarks> Use a cotton-tipped swab to apply it</p>
---	---

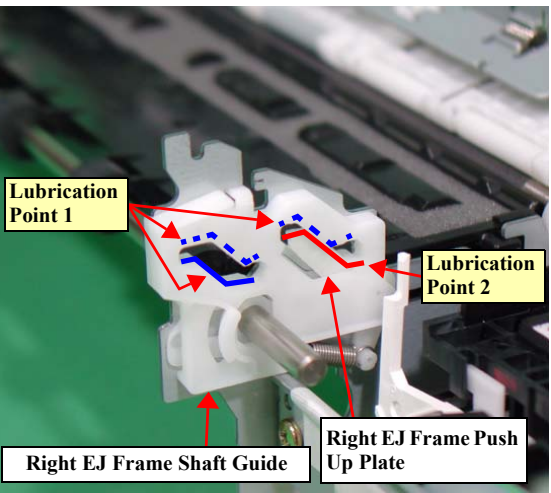
 <p>Lubrication Point 1</p> <p>Lubrication Point 2</p> <p>Right EJ Frame Shaft Guide</p> <p>Right EJ Frame Push Up Plate</p>	<p><Lubrication Point></p> <ol style="list-style-type: none"> Contact point between the EJ Frame and its shaft inside the Right EJ Frame Shaft Guide Contact point between the EJ Frame and its shaft on upper surface of the Right EJ Frame Push Up Plate <p><Lubrication Type></p> <ol style="list-style-type: none"> G-26 G-26 <p><Lubrication Amount></p> <ol style="list-style-type: none"> 3 points (Adequate dose) 1 point (Adequate dose) <p><Remarks> Use a brush to apply it</p>
--	--

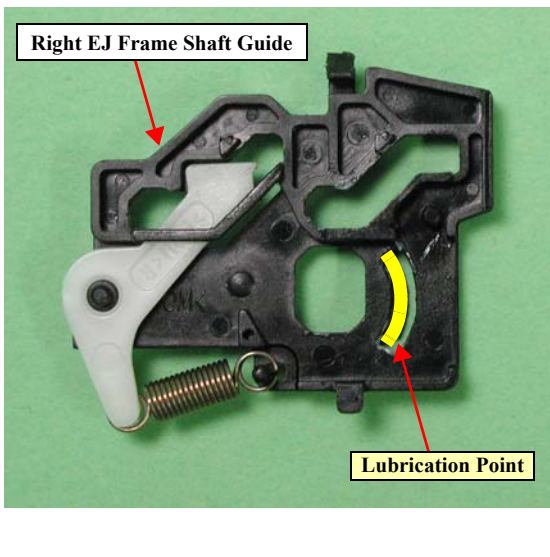
 <p>Right EJ Frame Shaft Guide</p> <p>Lubrication Point</p>	<p><Lubrication Point> Contact point between the Right EJ Frame Shaft Guide and the Front Paper Guide</p> <p><Lubrication Type> G-26</p> <p><Lubrication Amount> 1mm x 5mm</p> <p><Remarks> Use a cotton-tipped swab to apply it</p>
--	--

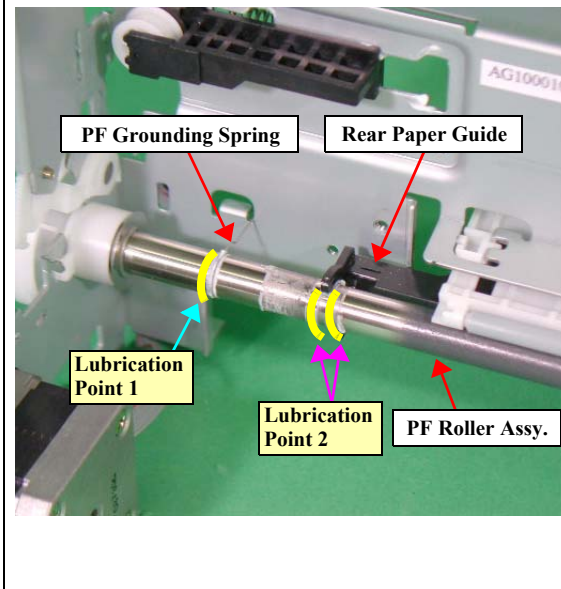
 <p>PF Grounding Spring</p> <p>Rear Paper Guide</p> <p>Lubrication Point 1</p> <p>Lubrication Point 2</p> <p>PF Roller Assy.</p>	<p><Lubrication Point></p> <ol style="list-style-type: none"> Contact point between the PF Grounding Spring and the PF Roller Assy. Surface of contact point between the PF Roller Assy. and the Rear Paper Guide <p><Lubrication Type></p> <ol style="list-style-type: none"> G-26 G-26 <p><Lubrication Amount></p> <ol style="list-style-type: none"> 1mm x Half periphery of "Roller, PF Assy." 1mm x 4mm x 2 points <p><Remarks> Use a syringe with a metallic needle to apply it.</p>
---	--

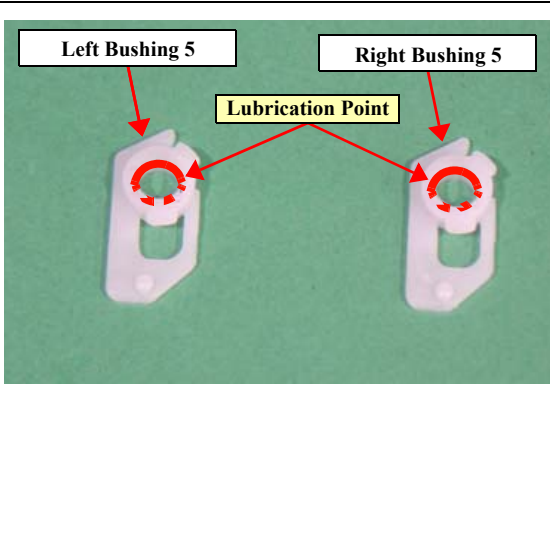
 <p>Left Bushing 5</p> <p>Right Bushing 5</p> <p>Lubrication Point</p>	<p><Lubrication Point> Inside surface of Bushing 5 (EJ Roller Assy.)</p> <p><Lubrication Type> G-26</p> <p><Lubrication Amount> Adequate dose</p> <p><Remarks> Use a cotton-tipped swab to apply it</p>
--	---

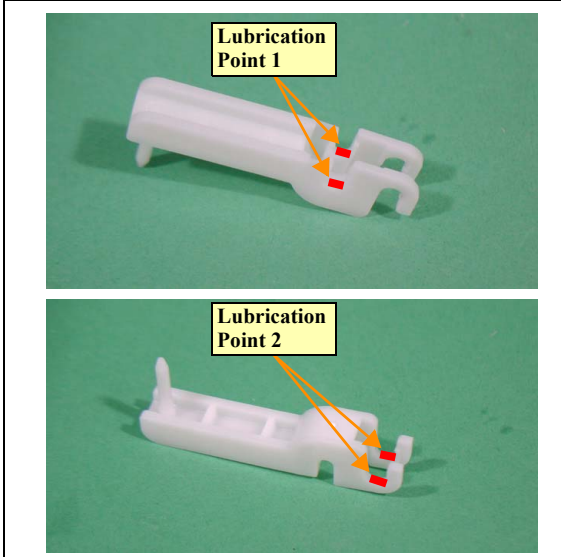
 <p>Lubrication Point 1</p> <p>Lubrication Point 2</p>	<p><Lubrication Point></p> <ol style="list-style-type: none"> Upper surface of curving area of the Idle Roller Holder Lower surface of curving area of the Idle Roller Holder <p><Lubrication Type></p> <ol style="list-style-type: none"> G-26 G-26 <p><Lubrication Amount></p> <ol style="list-style-type: none"> 2 points (Adequate dose) 2 points (Adequate dose) <p><Remarks> Use a brush to apply it</p>
--	--

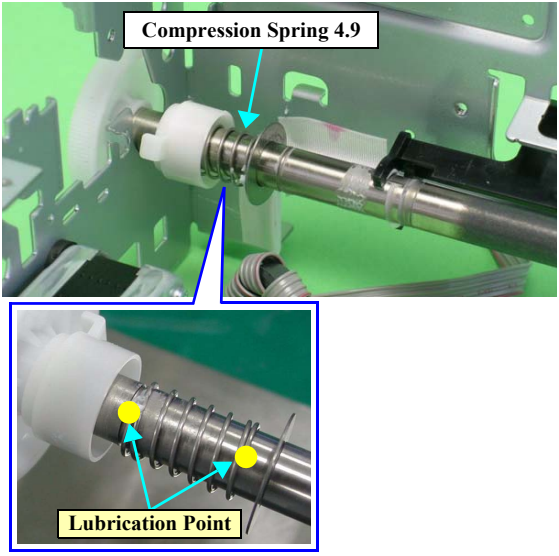
 <p>Compression Spring 4.9</p> <p>Lubrication Point</p>	<p><Lubrication Point> Two points on the Compression Spring 4.9 attached to the left side of the PF Roller Assy.</p> <p><Lubrication Type> G-26</p> <p><Lubrication Amount> 5mm x 7mm x 2 points</p> <p><Remarks> Use a brush to apply it</p>
--	---

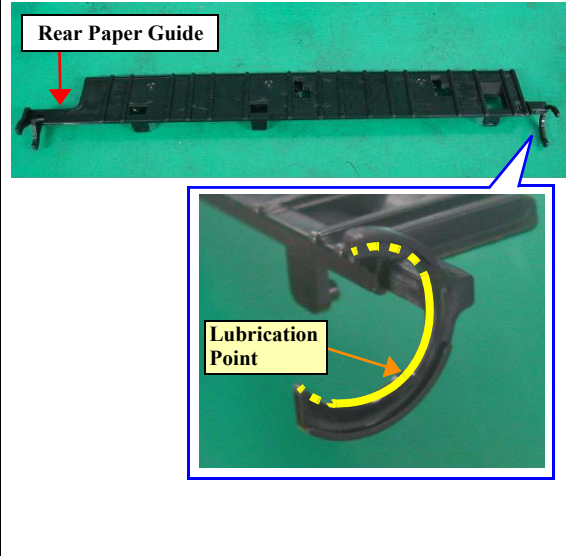
 <p>Rear Paper Guide</p> <p>Lubrication Point</p>	<p><Lubrication Point> The area on the Rear Paper Guide shown in the left figure.</p> <p><Lubrication Type> G-74</p> <p><Lubrication Amount> Adequate dose</p> <p><Remarks> Use a brush to apply it</p>
--	---

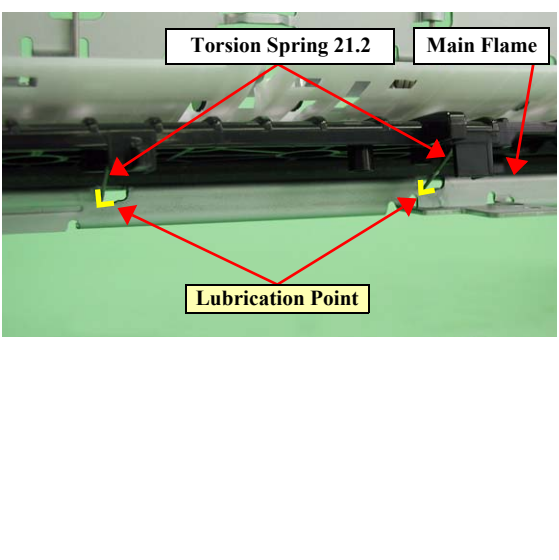
 <p>Torsion Spring 21.2</p> <p>Main Flame</p> <p>Lubrication Point</p>	<p><Lubrication Point> Contact point between the Main Flame and the Torsion Spring 21.2</p> <p><Lubrication Type> G-26</p> <p><Lubrication Amount> Adequate dose</p> <p><Remarks> Use a brush to apply it</p>
---	---

CHAPTER

5

APPENDIX

5.1 Block Diagram

The following diagrams show the Printer Mechanism and the Main Board.

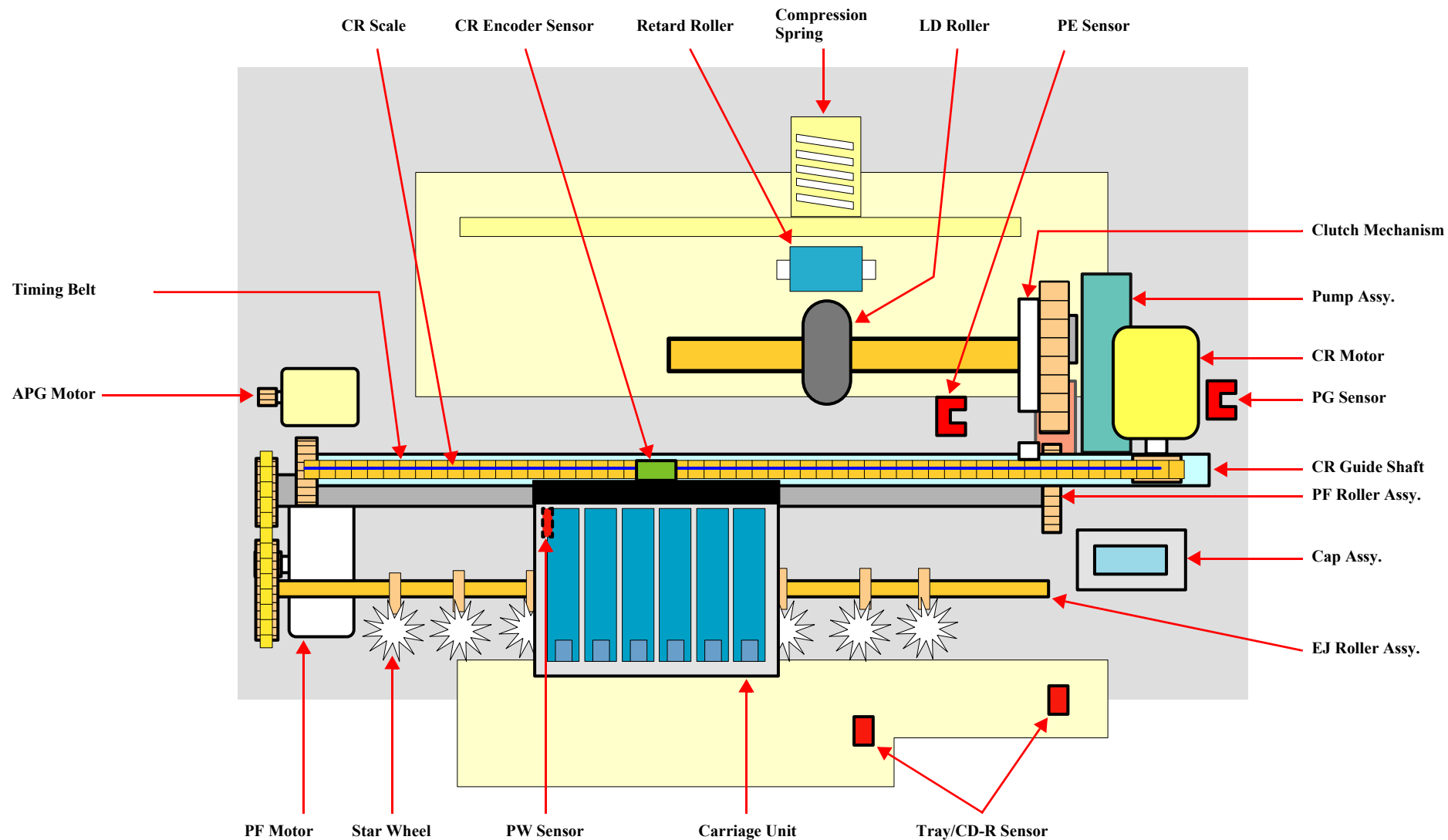

Figure 5-1. Printer Mechanism Block Diagram

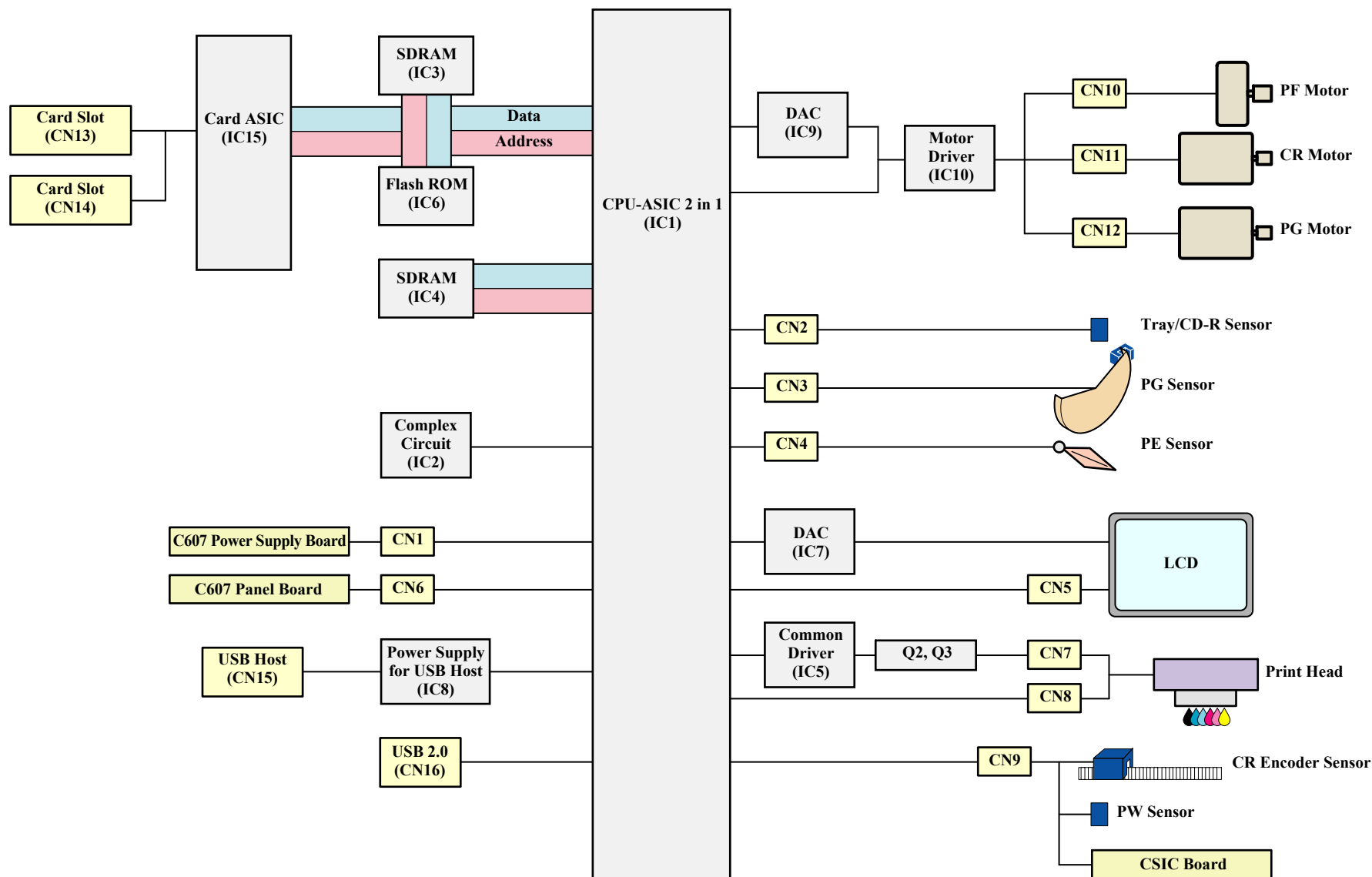

Figure 5-2. Main Board Block Diagram

5.2 Exploded Diagram

An exploded diagram is not provided in the Stylus Photo R340/350 Service Manual. If consultation of an exploded diagram is necessary, see the Exploded Diagram attached to the Stylus Photo R340/350 Parts List.

5.3 Electrical Circuits

The electric circuit diagrams below are provided on the following pages:

- Main Board (1) (C607MAIN)
- Main Board (2) (C607MAIN)
- Power Board (C607PSB)
- Power Board (C607PSE)
- Panel Board
 - Panel Board (C607PNL)
 - Panel Board (C607PNL-B)

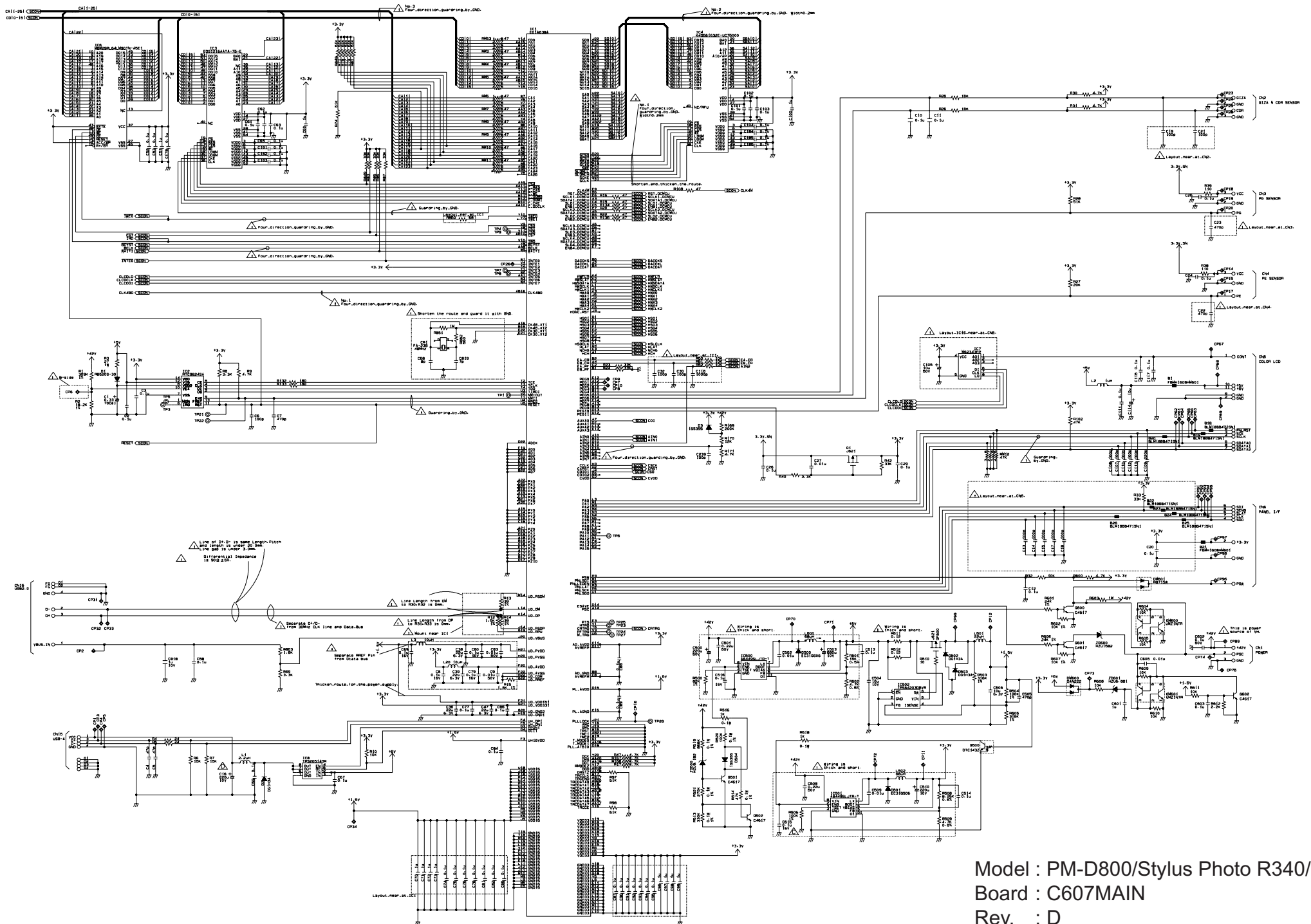

Model : PM-D800/Stylus Photo R340/350
 Board : C607MAIN
 Rev. : D
 Sheet : 1/2

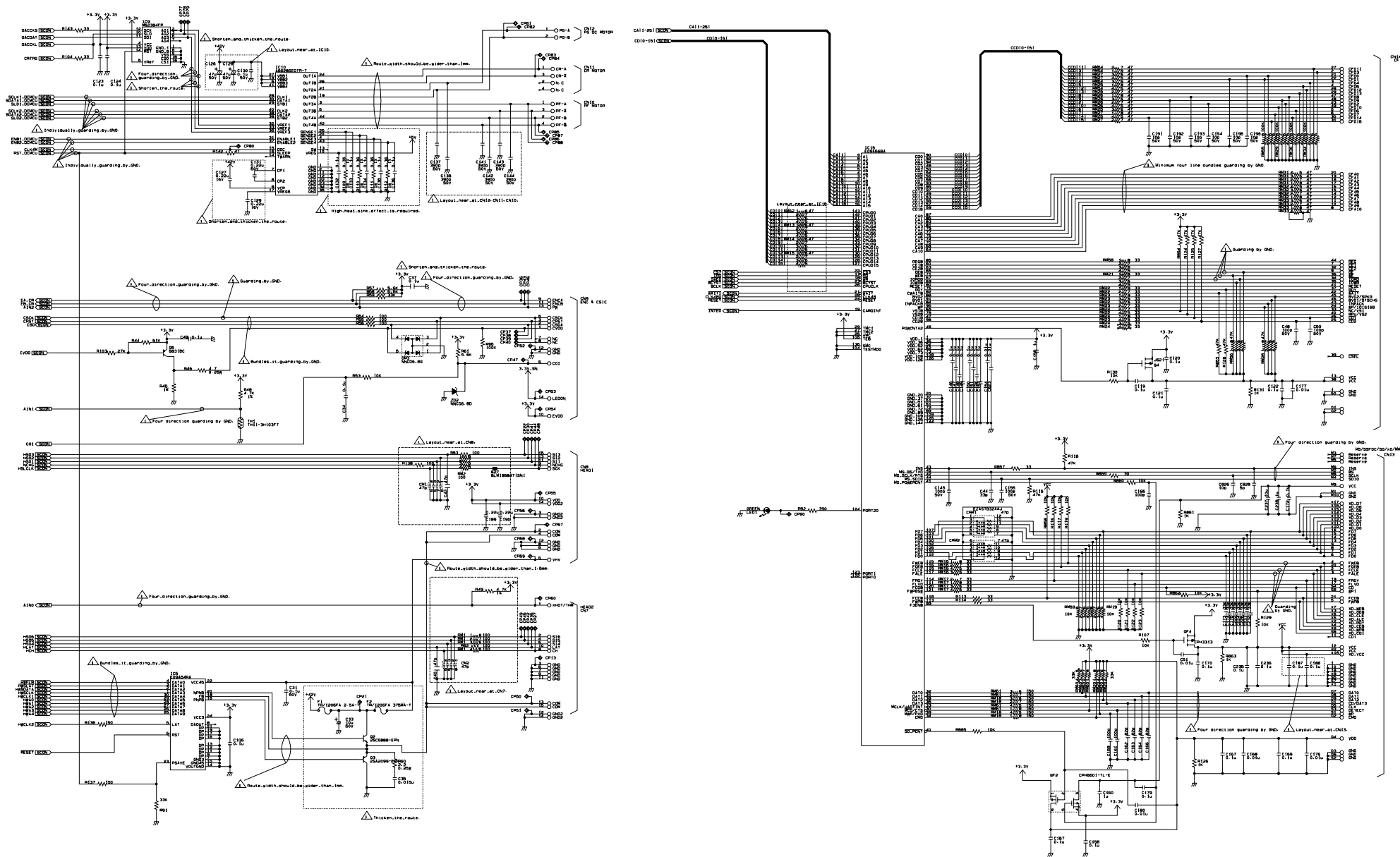

Model : PM-D800/Stylus Photo R340/350
 Board : C607MAIN
 Rev. : C
 Sheet : 2/2

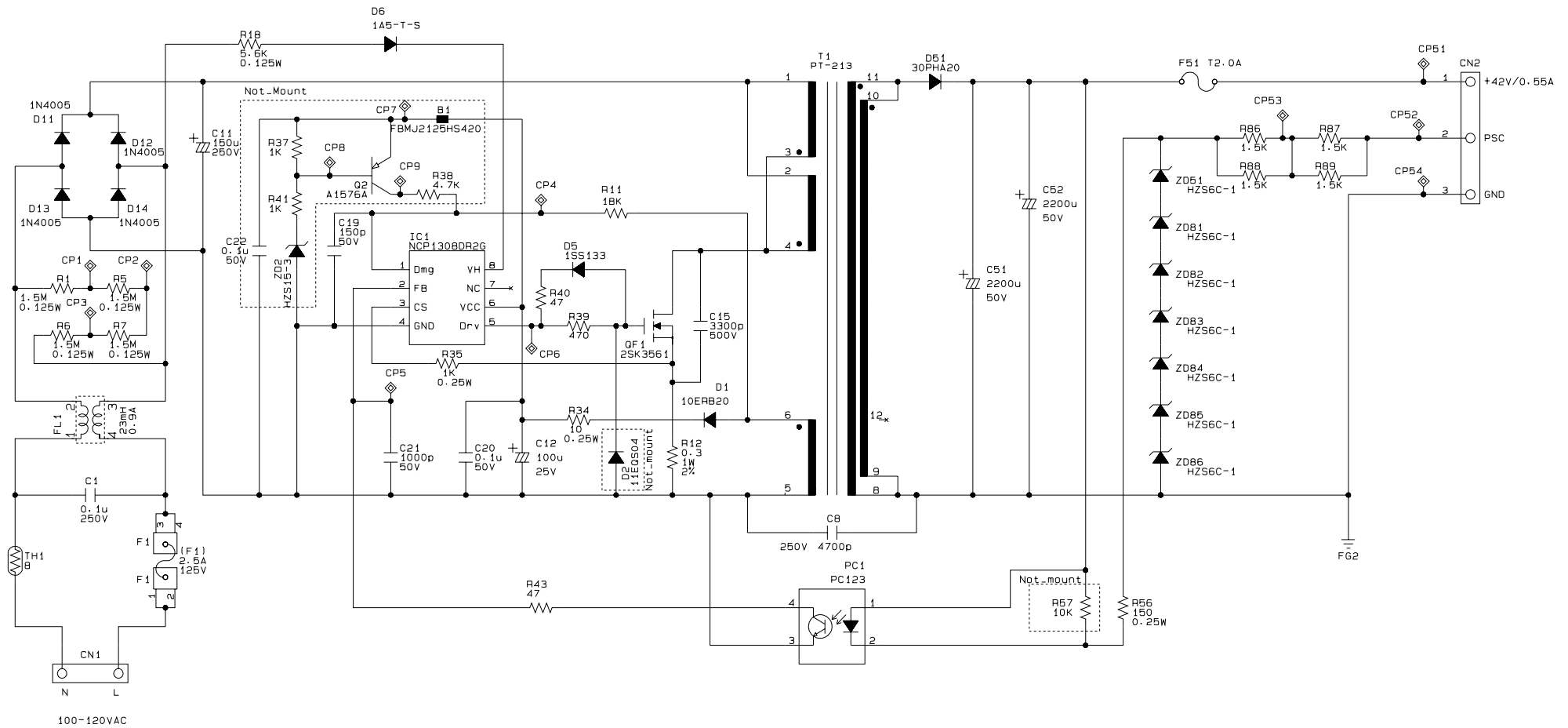

Model : PM-D800/Stylus Photo R340/350
 Board : C607PSB
 Rev. : B
 Sheet : 1/1

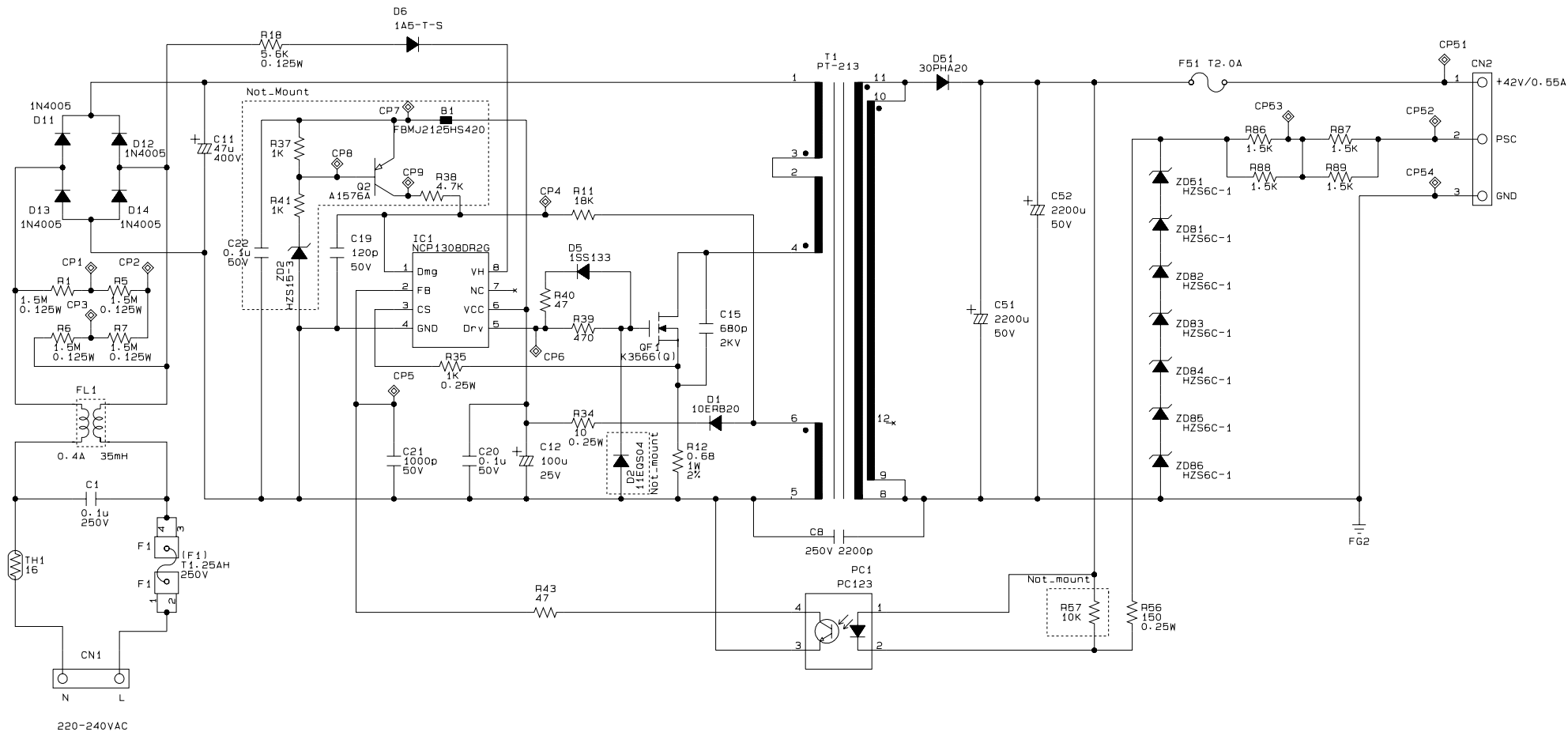

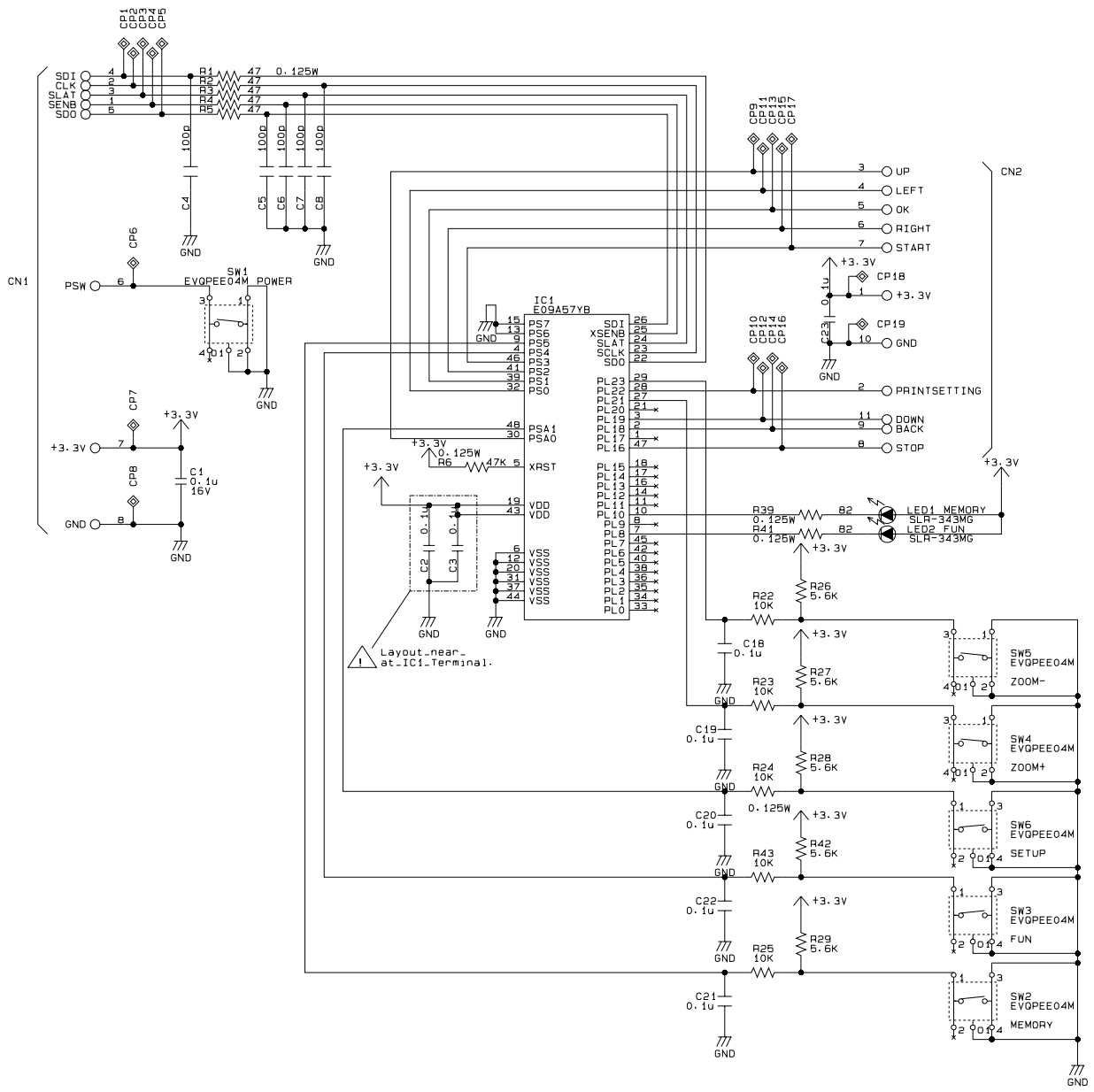

Model : PM-D800/Stylus Photo R340/350
 Board : C607PNL
 Rev. : B
 Sheet : 1/1

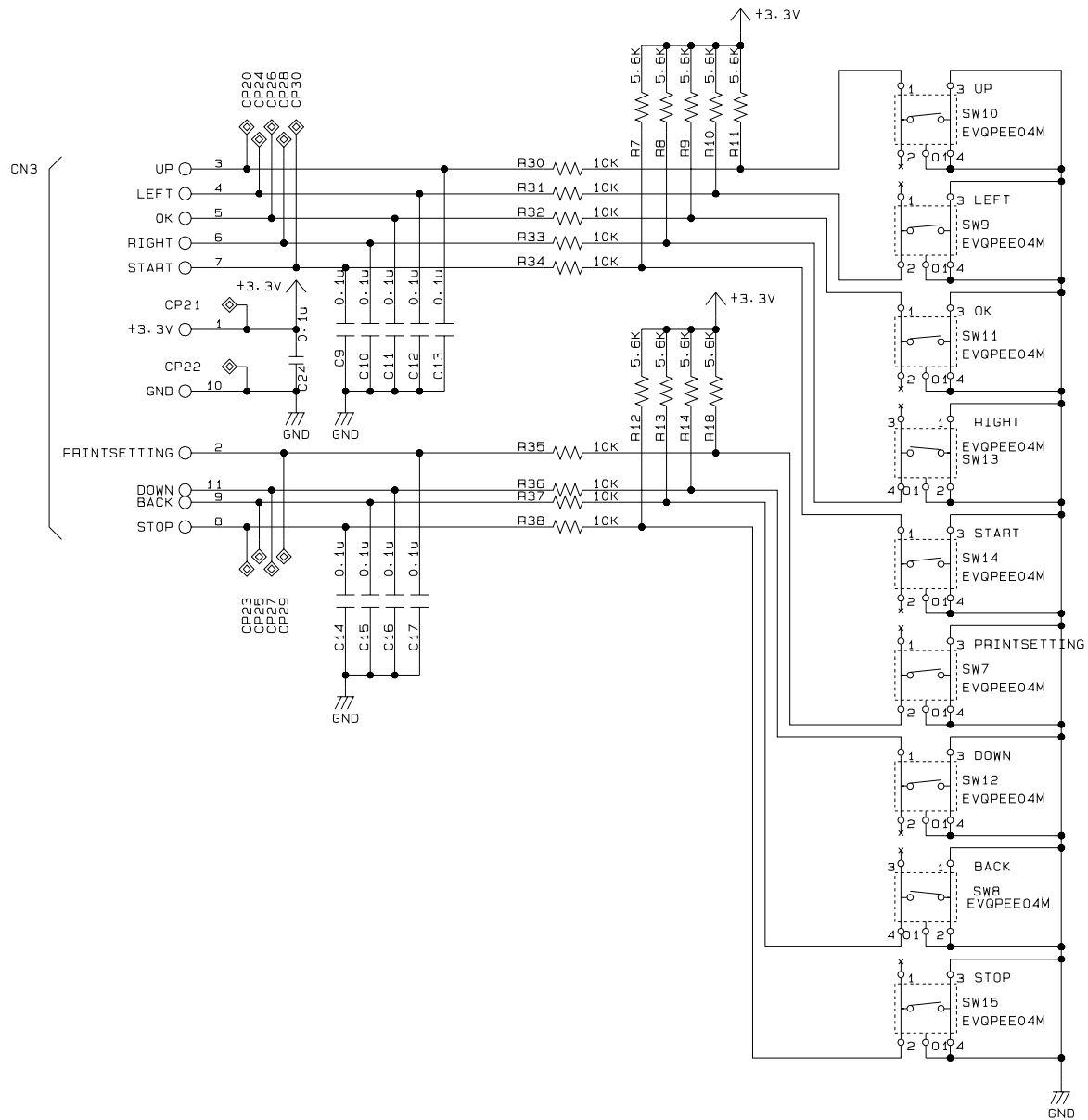

Model : PM-D800/Stylus Photo R340/350
 Board : C607PNL-B
 Rev. : A
 Sheet : 1/1