

**hp psc 2100 series
all-in-one**



i n v e n t



reference guide

© Copyright Hewlett-Packard Company 2002

All rights are reserved. No part of the document may be photocopied, reproduced, or translated to another language without the prior written consent of Hewlett-Packard Company.

This product incorporates Adobe's PDF technology, which contains an implementation of LZV licensed under U.S. Patent 4,558,302.



Adobe and the Acrobat logo are either registered trademarks or trademarks of Adobe Systems Incorporated in the United States and/or other countries.

Portions Copyright © 1989-2002 Palomar Software Inc. The HP PSC 2100 Series includes printer driver technology licensed from Palomar Software, Inc. www.palomar.com

Copyright © 1999-2002 Apple Computer, Inc.

Apple, the Apple logo, Mac, Mac logo, Macintosh, and Mac OS are trademarks of Apple Computer, Inc., registered in the U.S. and other countries.

Publication number: C8644-90213

First edition: May 2002

Printed in U.S.A., Mexico, Germany, Singapore, or China

Windows[®], Windows NT[®], Windows ME[®], Windows XP[®], and Windows 2000[®] are U.S.-registered trademarks of Microsoft Corporation.

Intel[®] and Pentium[®] are registered trademarks of Intel Corporation.

notice

The information contained in this document is subject to change without notice and should not be construed as a commitment by the Hewlett-Packard Company.

Hewlett-Packard assumes no responsibility for any errors that may appear in this document, nor does it make expressed or implied warranty of any kind with regard to this material, including, but not limited to, the implied warranties of merchantability and fitness for a particular purpose.

The Hewlett-Packard Company shall not be liable for incidental or consequential damages in connection with, or arising out of the furnishing, performance, or use of this document and the program material which it describes.

Note: Regulatory information can be found in the "Technical information" section of this guide.



It is not lawful in many places to make copies of the following items. When in doubt, check with a legal representative first.

- Governmental paper or documents:
 - Passports
 - Immigration papers
 - Selective service papers
 - Identification badges, cards, or insignias
- Governmental stamps:
 - Postage stamps
 - Food stamps
- Checks or drafts drawn on Governmental agencies
- Paper currency, traveler's checks, or money orders
- Certificates of deposit
- Copyrighted works

safety information



Warning! To prevent fire or shock hazard, do not expose this product to rain or any type of moisture.

Always follow basic safety precautions when using this product to reduce risk of injury from fire or electric shock.

WARNING: potential shock hazard

- 1** Read and understand all instructions in the setup poster.
- 2** Use only a grounded electrical outlet when connecting the unit to a power source. If you do not know whether the outlet is grounded, check with a qualified electrician.
- 3** Observe all warnings and instructions marked on the product.
- 4** Unplug this product from wall outlets before cleaning.
- 5** Do not install or use this product near water or when you are wet.
- 6** Install the product securely on a stable surface.
- 7** Install the product in a protected location where no one can step on or trip over the line cord, and where the line cord will not be damaged.
- 8** If the product does not operate normally, see the online Troubleshooting help.
- 9** No operator-serviceable parts inside. Refer servicing to qualified service personnel.
- 10** Use in a well-ventilated area.

contents

1	get help	1
2	quick start	3
	use your hp psc with a computer	4
3	load originals and load paper	7
	load originals	7
	load paper	8
	load envelopes	10
	load postcards or hagaki cards	11
	load photo paper	11
	tips for loading other types of paper in the paper tray	12
	set the paper type	13
	set the paper size	14
4	use the copy features	15
	make copies	15
	perform special copy jobs	18
	stop copying	21
	copy options	21
5	use the scan features	23
	scan an original	23
	stop scanning	24
6	maintain your hp psc	25
	clean the glass	25
	clean the lid backing	25
	clean the exterior	26
	work with print cartridges	26
	restore factory defaults	29
	set the power save time	30
	set scroll speed	30
	set the prompt delay time	30

- setup menu options 31
- 7 additional setup information33**
 - possible installation problems 33
 - set the language and region 35
 - set the front-panel view angle 35
 - connect your hp psc to your computer 36
 - remove and reinstall your hp psc software.37
- 8 technical information39**
 - system requirements 39
 - paper specifications 40
 - print specifications 41
 - print margin specifications 41
 - copy specifications. 42
 - scan specifications 43
 - physical specifications 43
 - power specifications. 43
 - environmental specifications 43
 - additional specifications 43
 - environmental product stewardship program 44
 - regulatory notices 44
 - declaration of conformity 46
- 9 get hp psc 2100 support.47**
 - get support and other information from the internet.47
 - hp customer support.47
 - prepare your unit for shipment. 48
 - hp distribution center 49
- 10 warranty information51**
 - warranty service 51
 - warranty upgrades. 51
 - returning your hp psc 2100 series for service 51
 - hewlett-packard limited global warranty statement52
- index.55**

get help

1

help	description
Setup Poster	The Setup Poster provides instructions for setting up and configuring your HP PSC. Make sure you use the correct poster for your operating system (Windows or Macintosh).
Product Tour	The tour provides a brief introduction to the HP PSC and its capabilities, so you can start using it immediately. You can take the tour immediately after installing the HP PSC software, or to take the tour at any time, see the product specific online help.
HP Photo & Imaging Help	The HP Photo & Imaging Help provides detailed information on using the software for your HP PSC. For Windows users: Go to the HP Director , and click Help . For Macintosh users: Go to the HP Director , and click Help , then click hp photo & imaging help .
Reference Guide	The Reference Guide contains information on using your HP PSC and provides additional troubleshooting assistance for the installation process. The Reference Guide also contains information on how to order supplies and accessories, technical specifications, support, and warranty information.
Troubleshooting help	To access troubleshooting information, go to the HP Director , then click Help . Open the Troubleshooting book in the HP Photo & Imaging Help, then follow the links to general troubleshooting as well as links to Troubleshooting help that is specific to your HP PSC. Troubleshooting is also available from the Help button that appears on some error messages.
Internet help and technical support	If you have Internet access, you can get more information from the HP website at: http://www.officejetsupport.com The website also provides answers to frequently-asked questions.

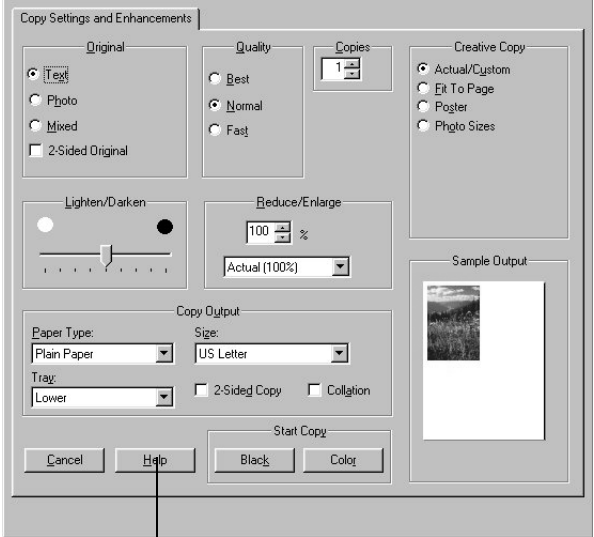
help	description
Readme file	<p>After you install your software, you can access the Readme file from either the HP PSC 2100 Series CD-ROM or the HP PSC 2100 Series program folder. The Readme file contains late-breaking information that does not appear in the Reference Guide or the online help. To access the Readme file, do the following:</p> <p>For Windows: go to the Windows taskbar, click Start, point to Programs or All Programs (XP), point to Hewlett-Packard, point to HP PSC 2100 Series, and then choose View the Readme File.</p> <p>For Macintosh: go to the HD:Applications:HP PSC Software folder.</p>
Dialog-box help (Windows only)	<p>For Windows: Clicking Help in a dialog box displays information about options and settings within the dialog box.</p>  <p>The image shows a screenshot of the 'Copy Settings and Enhancements' dialog box. The dialog box is titled 'Copy Settings and Enhancements' and contains several sections: 'Original' (with radio buttons for Text, Photo, Mixed, and a checkbox for 2-Sided Original), 'Quality' (with radio buttons for Best, Normal, Fast), 'Copies' (with a numeric field set to 1), 'Creative Copy' (with radio buttons for Actual/Custom, Fit To Page, Poster, Photo Sizes), 'Lighten/Darken' (with a slider), 'Reduce/Enlarge' (with a percentage field set to 100% and a dropdown for Actual (100%)), 'Copy Output' (with dropdowns for Paper Type: Plain Paper, Size: US Letter, Tray: Lower, and checkboxes for 2-Sided Copy and Collation), and 'Start Copy' (with buttons for Black and Color). At the bottom left, there are buttons for Cancel, Help, and Start Copy. A line points from the 'Help' button to the text below.</p> <p>To get help while working in a dialog box, click Help.</p>

quick start

2

You can perform many functions using either the front panel or the HP PSC software.

Even if you do not connect your HP PSC to a computer, you can use the front panel to copy documents or photos. You can change a wide variety of settings using the front-panel buttons and menu system.

front panel features

Review the illustrations below and identify the location of the buttons on the front panel. You will not use all of the front-panel features in the tutorial, but you may find it helpful to note the locations of all the buttons.

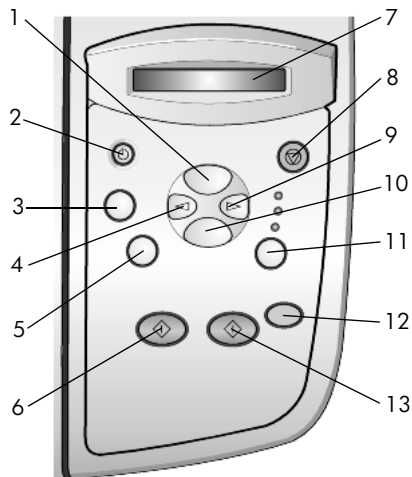

feature	purpose
1	Copy Options: use to access copy options, such as paper type, paper size, reduce/enlarge options, and lighter/darker options.
2	On: turns the HP PSC on and off.

feature	purpose
3	Setup: use to access menu options such as Scan Setup, Print Report, and Maintenance.
4	Left Arrow: use to scroll through menu settings or options.
5	Copies (1-99): use to change the number of copies for this copy job. This button can be used in conjunction with the arrow keys to change the number of copies.
6	Start Copy - Black: use to start a black and white copy.
7	Front-panel display: use to view system prompts and messages.
8	Cancel: use to stop a job, exit a menu, or exit button settings.
9	Right Arrow: use to scroll through menu settings or options.
10	Enter: use to select or save the displayed setting.
11	Quality: use to select the quality of the copy from Best, Normal, or Fast.
12	Start Scan: use to start the scan of an original from the glass to the designated Scan To destination on your Windows or Macintosh computer, if the HP PSC software is installed. If no change was made to the Scan To destination, the image will be scanned to the HP Photo & Imaging Gallery (Windows) or HP Scan Window (Macintosh).
13	Start Copy - Color: use to start a color copy.

use your hp psc with a computer

If you installed the HP PSC software on your computer according to the Setup Poster, you can access all the features of the HP PSC using the HP Director.

review the hp photo & imaging director

The HP Director is available through the desktop shortcut or when the HP PSC lid is raised (Windows only).

for windows users

- Do one of the following:
 - Double-click the **hp director** icon on the desktop.
 - In the Windows taskbar, click **Start**, point to **Programs** or **All Programs (XP)**, point to **Hewlett-Packard**, point to **hp psc 2000 series**, then choose **hp photo & imaging director**.
 - Raise the lid of the HP PSC.
This options works only if the HP PSC software is running.
- In the **Select Device** box, click to see a list of installed HP devices supported by this software.
- Select **hp psc 2100**.

The Director displays only the buttons that are appropriate for the selected device.

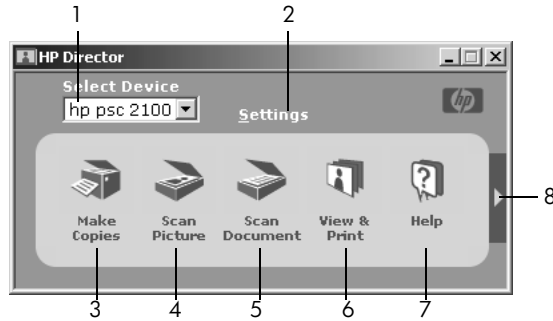

the hp photo & imaging director

feature	purpose
1	Select Device: Use this feature to select the product you want to use from the list of installed HP products.
2	Settings: Use this feature to view or change various settings for your HP device, such as print, scan, copy, or image unload.
3	Make Copies: Displays the Copy dialog box where you can select the copy quality, the number of copies, the color, the size, and can start a copy.
4	Scan Picture: Scans an image and displays it in the HP Photo & Imaging Gallery.
5	Scan Document: Scans text and displays it in the selected destination text editing software program.
6	View & Print: Displays the HP Photo & Imaging Gallery, where you can view and edit images, use HP Creative Printing, make and print a photo album, e-mail an image, and unload an image to the Web.
7	Help: Provides access to HP Photo & Imaging Help, which provides software help, a product tour, and troubleshooting information.
8	Click this arrow to access tool tips, which explain each of the Director options.

for macintosh users

- ▶ Do one for the following:
 - For OS 9, double-click the **HP Director** icon on the desktop.
 - For OSX, double-click the **HP Director** icon on the dock.

The following figure shows some of the features available through the HP Director for Macintosh. Consult the legend for a brief explanation of a specific feature.

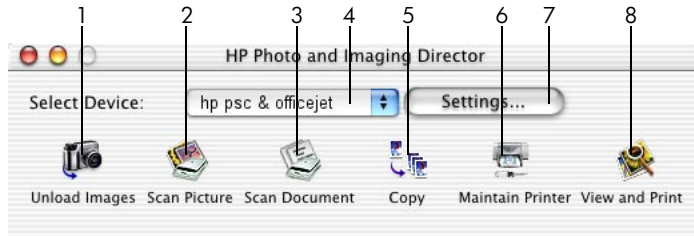

the director for macintosh

feature	purpose
1	Unload Images: Unloads images from a photo card.
2	Scan Picture: Scans an image and displays it in the HP Imaging Center.
3	Scan Document: Scans text and displays it in the selected destination text editing software program.
4	Use this pull-down list to select the product you want to use from the list of installed HP products.
5	Copy: Copies in black and white or color.
6	Maintain Printer: Starts the printer utility.
7	Settings: Provides access to device settings.
8	View and Print: Displays the HP Imaging Gallery, where you can view and edit images.

load originals and load paper

3

You can make copies from originals loaded on the glass. You can also print and copy onto a variety of paper types, weights, sizes, and transparency films. It is important, however, that you choose the right paper and make sure that it is loaded correctly and not damaged.

load originals

You can copy or scan any original by placing it on the glass.



Many of the **Reduce/Enlarge** options, such as **Fit to Page** or **Poster**, will not work correctly if the glass and lid backing are not clean. For more information, see **clean the glass** and **clean the lid backing** on page 25.

- 1 Lift the lid and place the original face down on the glass in the front-right corner with the sides of the originals touching the right and bottom edges.
It is important to use the front-right corner when using the copy feature.

Tip! If you are copying from a transparency (that is, your original is printed on transparency film), place a blank piece of paper on top of the transparency.

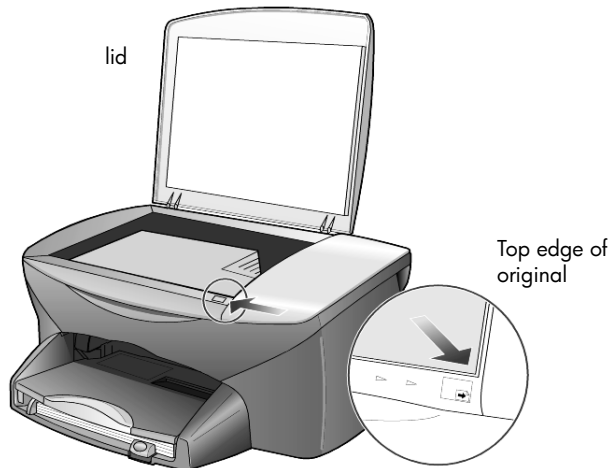

- 2 Close the lid.

load paper

Following is the basic procedure for loading paper. There are specific considerations for loading certain types of paper, transparency film, postcards, and envelopes. After you review this procedure, see **tips for loading other types of paper in the paper tray** on page 12, **load envelopes** on page 10, and **load postcards or hagaki cards** on page 11.

For best results, adjust the paper settings each time you change paper types or paper sizes. For more information, see **set the paper type** on page 13.

to load the paper tray

- 1 Remove the output tray, and slide the paper-width and paper-length guides to their outermost positions.

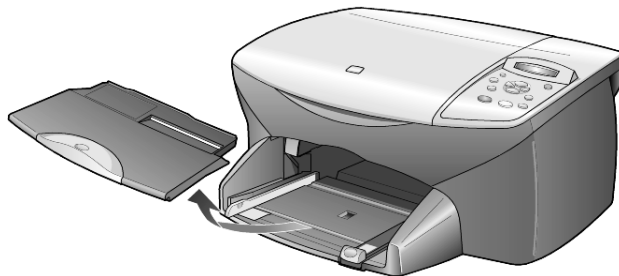

- 2 Tap the stack on a flat surface to align the edges of the paper, and then check the paper for the following:
 - Make sure it is free of rips, dust, wrinkles, and curled or bent edges.
 - Make sure all the paper in the stack is the same size and type, unless you are working with photo paper.
- 3 Insert paper into the paper tray print-side down until it stops. If you are using letterhead, insert the top of the page first.
Be careful not to use too much or too little paper. Check that the stack of paper contains several sheets but is no higher than the top of the paper-length guide.



- 4 Slide the paper-width and paper-length guides in until they stop at the edges of the paper. Make sure that the paper stack lies flat in the paper tray and fits under the tab of the paper-length guide.

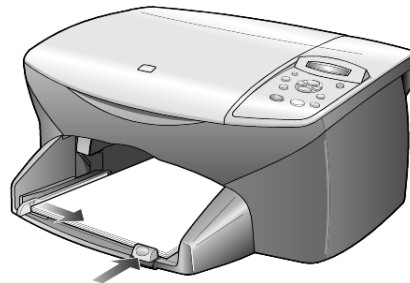

- 5 Replace the output tray.

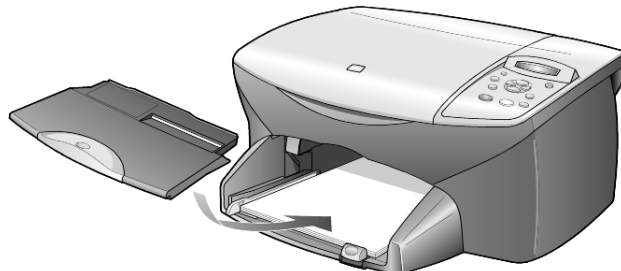

- 6 To prevent printed paper from falling off the tray, fully extend the output-tray extender.

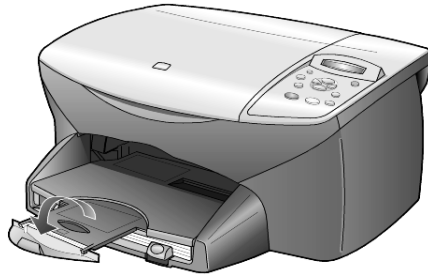

load envelopes

Use the print feature of your software to print to envelopes with your HP PSC. Your HP PSC provides two methods for working with envelopes. Do *not* use shiny or embossed envelopes, or envelopes that have clasps or windows.

- If you are printing one envelope, slide the envelope into the envelope slot, which is located on the right side toward the back of the output tray. Insert the envelope with the flap up and on the left, as shown in the illustration. Slide the envelope on the top until it stops.

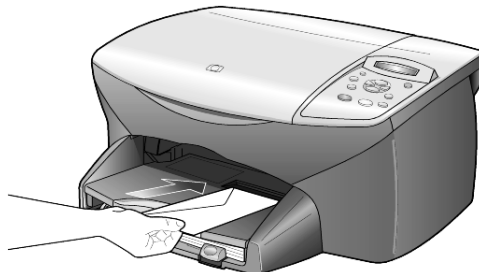

- If you are printing multiple envelopes, remove all paper from the paper tray, and then slide a stack of envelopes into the tray, with the envelope flaps up and to the left (print-side down), until they stop.

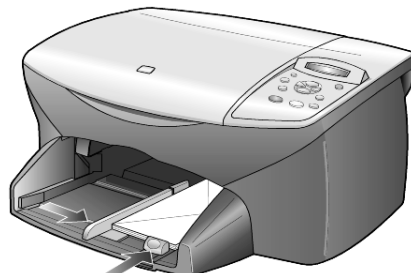

Adjust the paper-width guide against the envelopes (be careful not to bend the envelopes). Make sure the envelopes fit within the tray (do not overload it).

Consult the help files in your word processing software for details on how to format text for printing on envelopes.

load postcards or hagaki cards

Following is the procedure for loading postcards or hagaki cards.

- 1 Remove all paper from the paper tray, and then slide a stack of cards into the tray until they stop.

Make sure the print side faces down.

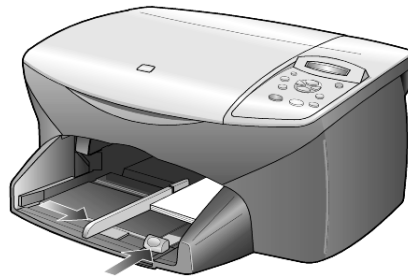

- 2 Adjust the paper-width guide against the cards, and then slide the paper-length guide in until it stops.

Make sure the cards fit within the tray (do not overload it).

load photo paper

Following is the procedure for loading 4-by-6 inch photo paper.

- 1 Remove all paper from the paper tray, and then slide a stack of cards into the tray until they stop.

Make sure the print side faces down.

If the photo paper you are using has perforated tabs, load the photo paper so that the tabs are closest to you.

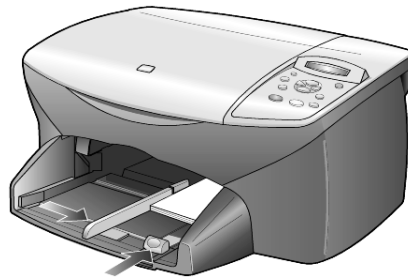

- 2 Adjust the paper-width guide against the cards, and then slide the paper-length guide in until it stops.
Make sure the cards fit within the tray (do not overload it).

tips for loading other types of paper in the paper tray

The following table provides guidelines for loading certain types of paper and transparency film. For best results, adjust the paper settings each time you change paper types and paper sizes. For more information, see **set the paper type** on page 13.

paper	tips
HP papers	<ul style="list-style-type: none"> • HP Premium Inkjet Paper: Locate the gray arrow on the nonprinting side of the paper, and then insert paper with the arrow side facing up. • HP Premium or Premium Plus Photo Paper: Load the glossy (print) side down. Always load at least five sheets of regular paper in the paper tray first, and then place the photo paper on top of the regular paper. • HP Premium or Premium Plus Inkjet Transparency Film: Insert the film so that the white transparency strip (with arrows and the HP logo) is on top and is going into the tray first. • HP Inkjet T-Shirt Transfer Iron-On: Flatten the transfer sheet completely before using it; do not load curled sheets. (To prevent curling, keep transfer sheets sealed in the original package until you are ready to use them.) Manually feed one sheet at a time, with the unprinted side facing down (the blue stripe faces up). • HP Greeting Cards, HP Linen Greeting Cards, or HP Felt-Textured Greeting Cards: Insert a small stack of HP greeting-card paper, with the print-side down into the paper tray until it stops.
Labels (works only with printing)	<ul style="list-style-type: none"> • Always use letter-size or A4-size label sheets designed for use with HP inkjet products (like Avery Inkjet Labels), and make sure that the labels are not over two years old. • Fan the stack of labels to make sure none of the pages are sticking together. • Place a stack of label sheets on top of standard paper in the paper tray, print-side down. Do <i>not</i> insert labels one sheet at a time.
Postcards or hagaki cards (only works with printing)	<p>Insert a stack of postcards or hagaki cards with the print-side down into the paper tray until it stops. Line the postcards up on the right side of the paper tray, slide the paper-width guide up against the left side of the cards, and then slide the paper-length guide in until it stops.</p>

paper	tips
4-by-6 inch photo paper (works only with printing)	<p>Insert the photo paper with the print-side down into the paper tray until it stops. Place the long edge of the photo paper against the right side of the paper tray, slide the paper-width guide up against the long edge of the photo paper, and slide the paper-length guide in until it stops. If the photo paper you are using has perforated tabs, load the photo paper so that the tabs are closest to you.</p>
Continuous (banner) paper (works only with printing)	<p>Continuous banner paper is also known as computer or z-fold paper.</p> <ul style="list-style-type: none"> • Before loading banner paper, remove all other paper from the paper tray, then remove the output tray. <div style="display: flex; align-items: center; justify-content: center;"> <div style="margin-right: 20px;"> <p>Remove the output tray.</p> <p>Insert the unattached edge of the paper into the paper tray.</p> </div>  </div> <ul style="list-style-type: none"> • If you use non-HP banner paper, use 20-lb. paper and fan the paper before loading it. • Verify that the stack of banner paper contains at least five pages in the stack. • Carefully tear off the perforated edge strips from both sides of the paper stack, if any, and unfold and refold the paper to make sure the pages do not stick together. • Put the paper in the paper tray so that the unattached edge is at the top of the stack. Insert the first edge into the paper tray until it stops, as shown in the illustration above.

set the paper type

If you want to use a different type of paper, such as photo paper, transparency film, t-shirt transfer paper, or brochures, simply load that paper in the paper tray. You should then change the paper type settings to ensure the best print quality.

HP recommends paper type settings according to the type of paper you're using.

This setting refers to copy options only. If you want to set the paper type for printing, set the properties from the Print dialog box.

- 1 Press **Copy Options** until **Paper Type** appears, then press **Enter**.
- 2 Press  until the appropriate paper type appears.

- 3 Press **Enter** to choose the displayed paper type.

set the paper size

The HP PSC can use Letter or A4 paper. Use the following procedure to set the paper size for copying.

- 1 Press **Copy Options** until **Paper Size** appears, then press **Enter**.
- 2 Press  until the appropriate paper size appears.
- 3 Press **Enter** to choose the displayed paper size.

use the copy features

4

The copy features let you do the following:

- Produce high-quality color and black-and-white copies using a variety of paper types and sizes, including iron-on transfers.
- Reduce or enlarge the size of the copies you make from 25% to 400% of the copy's original size.
- Make the copy lighter or darker, adjust the color intensity, select the number of copies, and specify the quality of the copies you make.
- Use special copying features to create a poster, make many sizes of photos, make high-quality copies of photos using special photo paper, or to create transparencies.

make copies

You can make copies using the front panel of your HP PSC or by using the HP PSC software on your computer. Many copy features are available using either method. However, you may find that the software offers easier access to special copy features.

All copy settings that you select on the front panel are reset **two minutes** after the HP PSC completes the copy, unless you save the settings as the default settings, as described in **change settings for all copy tasks** on page 17.

make a copy

- 1 Load your original on the glass.
- 2 Press **Start Copy, Black** or **Start Copy, Color**.

increase copy speed or quality



The HP PSC provides three options that affect copy speed and quality.

- **Best** produces the highest quality for all paper and eliminates the banding (striping) effect that sometimes occurs in solid areas. **Best** copies more slowly than the other quality settings.
- **Normal** delivers high-quality output and is the recommended setting for most of your copying. **Normal** copies faster than **Best**.
- **Fast** copies faster than the **Normal** setting. The text is of comparable quality to the **Normal** setting, but the graphics may be of lower quality. Using **Fast** also cuts down on the frequency of replacing your print cartridges, because it uses less ink.

- 1 Load your original on the glass.
- 2 Press **Quality** until the green light in front of the desired quality is lit.
- 3 Press **Start Copy, Black** or **Start Copy, Color**.

set the number of copies



You can set the number of copies using the front panel.

- 1 Do one of the following:
 - Press **Copies (1-99)** until the desired number of copies appears.
 - Press **Copies (1-99)**, then press  or  to select the number of copies.
If you hold down the right arrow button, the number of copies changes by increments of 5 to make it easier to set a large number of copies.
- 2 Press **Start Copy, Black** or **Start Copy, Color**.

reduce or enlarge a copy



You can reduce or enlarge a copy of an original using **Reduce/Enlarge**.

For more information about additional copy options such as **Fit to Page**, **Many on a Page**, and **Poster**, see **perform special copy jobs** on page 18.

- 1 Press **Copy Options** until **Reduce/Enlarge** appears.
- 2 Press **Enter** to select the option.
- 3 Press  to choose a **Reduce/Enlarge** option.
- 4 If you are using the **Custom** option, press **Enter**, then press  or  to select a percentage. Press **Enter** when the desired percentage is displayed.
- 5 Press **Start Copy, Black** or **Start Copy, Color**.

make copies lighter or darker

Use **Lighter/Darker** to adjust the lightness and darkness of the copies you make.

- 1 Press **Copy Options** until **Lighter/Darker** appears, and then press **Enter**.
The range of **Lighter/Darker** values appears as a circle on a scale on the front-panel display.
- 2 Press  to lighten the copy or  to darken it.

The circle moves to the left or right, depending on the button you press.

- 3 Press **Start Copy, Black** or **Start Copy, Color**.

enhance text sharpness and photo colors



Use **Text** enhancements to sharpen edges of black text. Use **Photo** for photographs or pictures to enhance light colors that may otherwise appear white. Use **Mixed** when your original has both text and graphics.

Text enhancement is the default option. You can turn off **Text** enhancement by selecting **Photo** or **None** if the following occur:

- Stray dots of color surround some text on your copies.
 - Large, black typefaces look splotchy (not smooth).
 - Thin, colored objects or lines contain black sections.
 - Horizontal grainy or white bands appear in light- to medium-gray areas.
- 1 Press **Copy Options** until **Enhancement** appears, and then press **Enter**.
 - 2 Press  until the desired enhancement (**Text**, **Photo**, **Mixed**, or **None**) appears.
 - 3 Press **Start Copy, Black** or **Start Copy, Color**.

change color intensity

You can adjust color intensity to make colors on your copy more vivid or more subtle.

- 1 Press **Copy Options** until **Color Intensity** appears, and then press **Enter**. The range of color intensity values appears as a circle on a scale on the front-panel display.
- 2 Press  to make the image more pale or  to make the image more vivid. The circle moves to the left or right, depending on the button you press.
- 3 Press **Start Copy, Black** or **Start Copy, Color**.

change settings for all copy tasks

Save the copy settings you use most often by setting them as the default. This includes changes to **Copy Options**, such as **Paper Type** and **Paper Size**, as well as other Copy settings on the front panel, such as **Copies (1-99)**, and **Quality**.

- 1 Make any desired changes to the **Copy Options**.
- 2 Press **Copy Options** until **Set New Defaults** appears.
- 3 Press **Enter**.
- 4 Press  until **Yes** appears.
- 5 Press **Enter** to set the option as a default. Your settings are saved.

perform special copy jobs

In addition to supporting standard copying, your HP PSC can also do the following:

- **copy a photo**
- **fit a copy to the page**
- **print several copies on one page**
- **make a poster**
- **prepare a color t-shirt transfer**

copy a photo

When copying a photo, you should select options for the correct paper type and photo enhancement. You may also want to use the photo print cartridge for superior print quality.

- 1 Load the photo on the glass.
- 2 If you are using photo paper, load it in the paper tray.
- 3 Press **Copy Options** until **Paper Type** appears, then press **Enter**.
- 4 Press **▶** until the desired photo paper option appears, then press **Enter** to select it.
- 5 Press **▶** until **Enhancements** appears, then press **Enter** to select it.
- 6 Press **▶** until **Photo** appears, then press **Enter** to select it.
- 7 Press **Start Copy, Black** or **Start Copy, Color**.

Tip! To enlarge a photo automatically to a full page, use the **Fit to Page** feature.

fit a copy to the page

Use **Fit to Page** when you want to automatically enlarge or reduce your original to fit the paper size you have loaded. You can enlarge a small photo to fit a full-size page, as shown below, or you can use this feature to easily copy a Legal original to Letter paper or vice versa. Using **Fit to Page** may prevent unwanted cropping of text or images around the margins.

Tip! Make sure that the glass is clean and the original has been placed in the front-right corner of the glass.

Original



Fit to Page

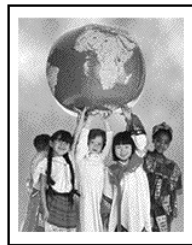

- 1 Load the original on the glass.
- 2 Press **Copy Options** until **Reduce/Enlarge** appears, then press **Enter**.
- 3 Press **▶** until **Fit to Page** appears, then press **Enter**.
- 4 Press **Start Copy, Black** or **Start Copy, Color**.

print several copies on one page

You can place multiple copies of an original on one page by selecting a photo size and then selecting the number of copies you want.

There are several common photo sizes available from the **Reduce/Enlarge** option, which you access from the **Copy Options** button. After you select one of the available sizes by pressing **Enter**, you may be prompted to select the number of copies that can be placed on the page if there is room for more than one.

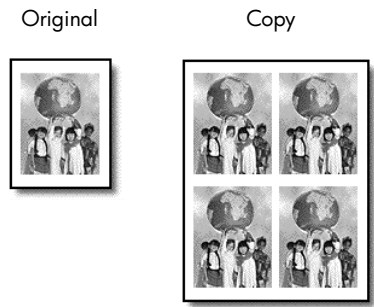

- 1 Load the original on the glass.
- 2 Press **Copy Options** until **Reduce/Enlarge** appears, then press **Enter**.
- 3 Press **▶** until the desired photo size appears, then press **Enter**.
- 4 Press **▶** to select the maximum number of images that will fit on the page or one image per page.
Some larger sizes do not prompt you for a number of images. If this is so, only one image is copied to the page.
- 5 Press **Enter** to select the number of photos you want to copy to a page.
- 6 Press **Start Copy, Black** or **Start Copy, Color**.

Tip! If the number of copies of the photo on a single page does not come out as expected, try turning the original on the glass 90 degrees and start the copy again.

make a poster

When you use the Poster feature you divide your original into sections, then enlarge the sections so you can assemble them into a poster.

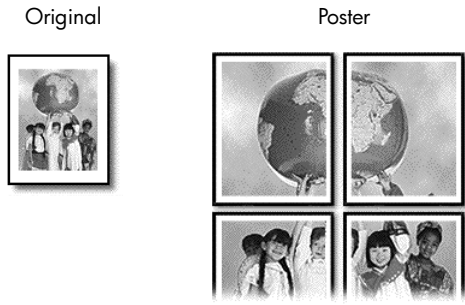

- 1 Load the original on the glass.
- 2 Press **Copy Options** until **Reduce/Enlarge** appears, then press **Enter**.
- 3 Press **▶** until **Poster** appears, then press **Enter**.
The default poster size is 2-pages wide.
- 4 Do one of the following:
 - Press **Enter** to select the default poster size.
 - Press **▶** to select other poster size options, then press **Enter** to confirm your selection.
- 5 Press **Start Copy, Black** or **Start Copy, Color**.

Tip! After you select the poster width, the HP PSC adjusts the length automatically to maintain the proportions of the original. If the original cannot be enlarged to the selected poster size, an error message appears that tells you the number of pages wide that are possible. Select a smaller poster size and make the copy again.

prepare a color t-shirt transfer

Use the **Iron-On** feature to reverse text and images so that they appear backwards. After you iron a transfer onto a T-shirt, the picture appears properly on the shirt.



Tip! We recommend that you practice applying a T-shirt transfer on an old garment first.

- 1 Load the original on the glass.
- 2 Load the T-shirt transfer paper in the paper tray.
- 3 Press **Copy Options** until **Paper Type** appears, then press **Enter**.
- 4 Press **▶** until **Iron-On** appears and then press **Enter** to select it. Selecting this option automatically copies a mirror-image of your original.
- 5 Press **Start Copy, Black** or **Start Copy, Color**.

stop copying

- ▶ To stop copying, press **Cancel** on the front panel.

copy options

The following diagram shows the options that are available from the **Copy Options** button.

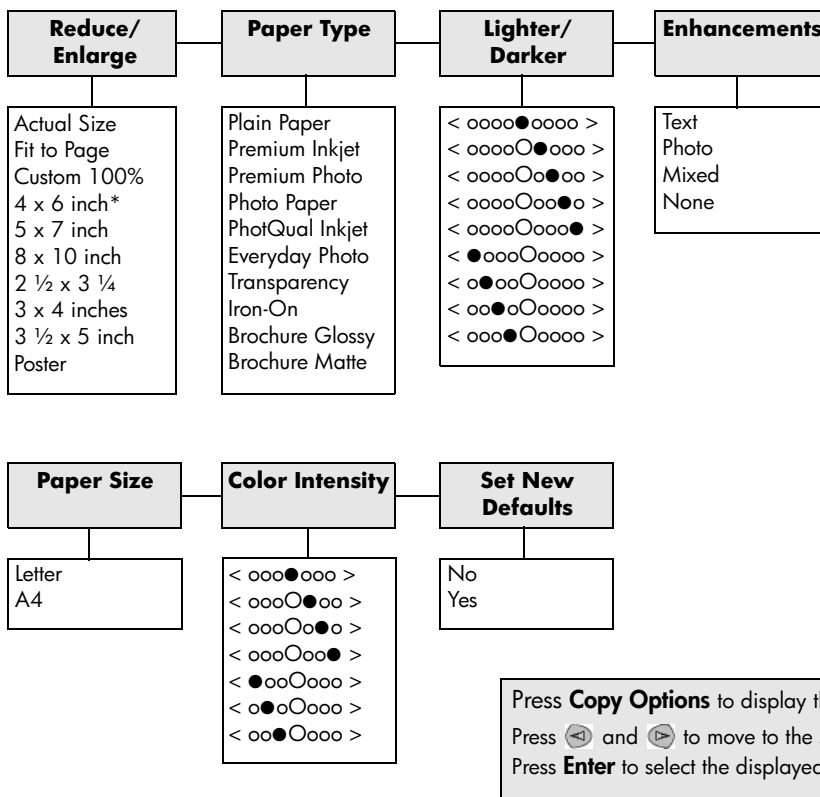

*The sizes vary by country/region.

use the scan features

5

Scanning is the process of converting text and pictures into an electronic format for your computer. You can scan just about anything:

- Photos
- Magazine articles
- Text documents
- 3D objects (be careful not to scratch the glass) to put into catalogs and flyers

Because the scanned image or text is in an electronic format, you can bring it into your word processor or graphics program and modify it to suit your needs. You can do the following:

- Scan text from an article into your word processor and quote it in a report, saving you a lot of retyping.
- Scan in a logo and use it in your publishing software, allowing you to print business cards and brochures for yourself.
- Scan in photos of your kids and e-mail them to relatives, create a photographic inventory of your house or office, or create an electronic scrapbook.

To use the scan features, your HP PSC and computer must be connected and turned on. The HP PSC software should also be installed and running on your computer prior to scanning. To verify that the HP PSC software is running, look for a status icon in the system tray.

For more information about scanning your documents, pictures, or negatives from the HP PSC software, see **scan pictures and documents** in the HP Photo & Imaging Help for more information.

scan an original

You can start a scan from your computer or from your HP PSC.

to scan an original to your Windows computer

- 1 Load your original on the glass.
- 2 Press **Start Scan**.
A scan of the original appears in the HP Image Viewer.
- 3 In the HP Image Viewer window, you can edit the scanned image. When you have finished, click **Accept**.
For more information about making changes to an image during the preview, see **adjust an image during the preview** in **scan pictures and documents** in the HP Photo & Imaging Help for more information.
The HP PSC does a final scan of the original and sends the image to the HP Photo & Imaging Gallery.
See **manage images** in **how to use the software** for more information about using the HP Photo & Imaging Gallery.

to scan an original from your Macintosh computer

- 1 Load your original on the glass.
For more information, see **load originals** on page 7.
- 2 Press **Start Scan**.
The HP PSC scans the original and sends the image to the HP Photo & Imaging Gallery.
See the HP Photo & Imaging Gallery online help for more information.

scan to a different software program

If you prefer to scan your document to a software program other than the HP Photo & Imaging Gallery or HP Imaging Center, you can choose a different program from the **Scan To** list that appears in the front-panel display. The HP PSC scans the document, launches the selected software program, and displays the scanned image in that program.

- 1 Load your original.
For more information, see **load originals** on page 7.
- 2 Press **Setup** until **Scan Setup** appears.
- 3 Press  to scroll through the **Scan To** list until the desired scan-to software program appears.
- 4 Press **Start Scan** to begin the scan.
The HP PSC scans your original and displays it in the selected software program.

stop scanning

You can stop a scan by pressing the **Cancel** button located on the front panel.

maintain your hp psc

6

This section provides instructions for keeping your HP PSC in top working condition. Perform these maintenance procedures as necessary.

clean the glass

Dirty glass, from fingerprints, smudges, hair, and so on, slows down performance and affects the accuracy of features such as Fit to Page and Copy.

- 1 Turn off the unit, unplug the power cord, and raise the lid.
- 2 Clean the glass with a soft cloth or sponge slightly moistened with a nonabrasive glass cleaner.

Caution! Do not use abrasives, acetone, benzene, or carbon tetrachloride on the glass; these can damage it. Do not place liquids directly on the glass. They may seep under it and damage the unit.

- 3 Dry the glass with a chamois or cellulose sponge to prevent spotting.

clean the lid backing

Minor debris can accumulate on the white document-backing located underneath the unit's lid.

- 1 Turn off the unit, unplug the power cord, and raise the lid.
- 2 Clean the white document-backing with a soft cloth or sponge slightly moistened with a mild soap and warm water.
- 3 Wash the backing gently to loosen debris; do not scrub the backing.
- 4 Dry the backing with a chamois or soft cloth.

Caution! Do not use paper-based wipes as these may scratch the backing.

- 5 If this does not clean the backing well enough, repeat the previous steps using isopropyl (rubbing) alcohol, and wipe the backing thoroughly with a damp cloth to remove any residual alcohol.

clean the exterior

Use a soft, damp, lint-free cloth to wipe dust, smudges, and stains off the case. The interior of the unit does not require cleaning. Keep fluids away from the interior of the unit as well as the front panel.

work with print cartridges

To ensure the best print quality from your HP PSC, you will need to perform some simple maintenance procedures, and when prompted by a front-panel message, replace the print cartridges.

print a self-test report

If you are experiencing problems with printing, before cleaning or replacing the print cartridges, you should print a self-test report. This report provides useful information about your print cartridges, including status information and ink levels.

- 1 Press **Setup** until **Print Report** appears, and then press **Enter**.
- 2 Press  until **Self-Test** appears, and then press **Enter**.

A self-test report is printed for your HP PSC, which may indicate the source of any problems you may be having.

handle print cartridges

Before you replace or clean a print cartridge, you should know the part names and how to handle the print cartridge.

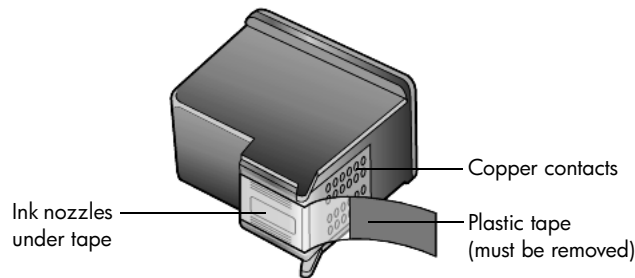

Do not touch the copper contacts or the ink nozzles

use the print cartridge protector

The print cartridge protector is designed to keep your print cartridge secure when it is not being used. Whenever you remove a print cartridge from the printer, store it in the print cartridge protector that came with your printer.

- To insert a print cartridge into the print cartridge protector, slide the print cartridge into the print cartridge protector at a slight angle and snap it securely into place.
- To remove the print cartridge from the print cartridge protector, press down and back on the top of the print cartridge protector to release the print cartridge, then slide the print cartridge out of the print cartridge protector.

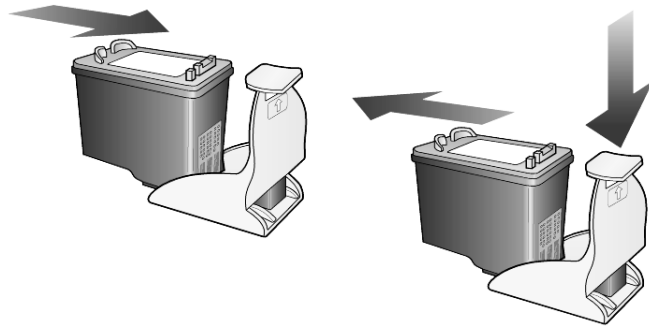

replace the print cartridges

Front-panel display messages appear to let you know that you should replace your print cartridges.

You may also need to replace a print cartridge when you want to use the photo print cartridge for printing high-quality photos.

See **order print cartridges** on page 61 for information on ordering replacement print cartridges.

- 1 Turn on the unit, then open the print-carriage access door by lifting the handle until the door locks into place. The print carriage moves to the center of the unit.

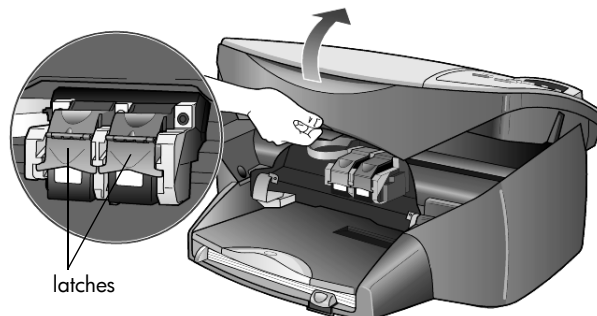

- 2 After the carriage stops moving, lift the latch to release the print cartridge, then pull it toward you out of its slot.

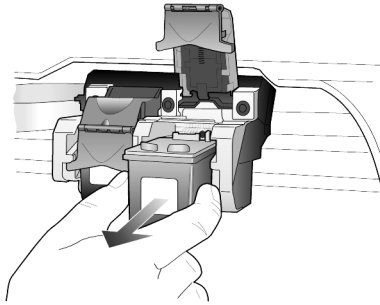

- 3 If you are removing the black print cartridge in order to install the photo print cartridge, store it in the print cartridge protector.
- 4 Remove the new print cartridge from its packaging and, being careful to touch only the black plastic, gently remove the plastic tape.

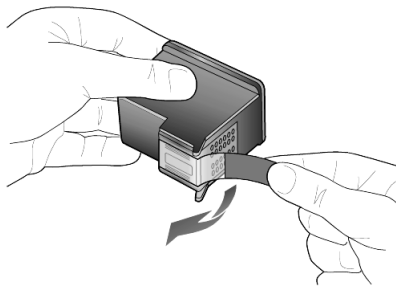

Caution! Do not touch the copper contacts or ink nozzles.

- 5 Push the new print cartridge into the appropriate slot until it clicks into place.
The tri-color print cartridge goes on the left and the black or photo print cartridge goes on the right.

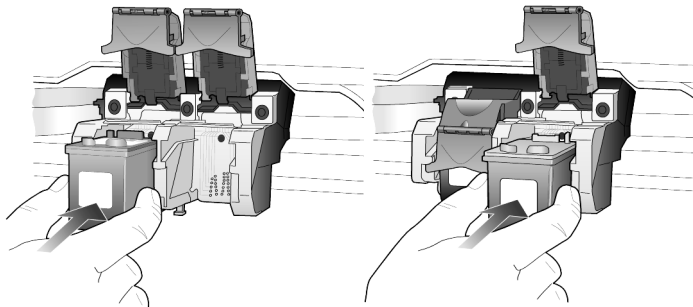

- 6 Pull the end of the latch toward you, press down until it stops, and then release. Make sure the latch catches below the bottom tabs.

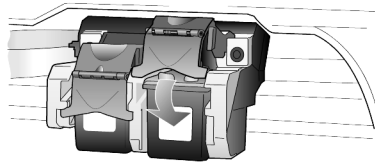

- 7 Close the print-carriage access door.

align cartridges

The HP PSC prompts you to align cartridges every time you install or replace a print cartridge. Aligning the cartridges ensures high-quality output.

To align the print cartridges when prompted:

- 1 Press **Enter** on the front panel.
Two pages are printed, one with instructions and one with patterns.
- 2 Follow the instructions on the instruction page, then place the page with patterns on the glass and press **Start Scan**.
The cartridges are aligned correctly.

To align the cartridges at any other time:

- 1 Press **Setup** until **Maintenance** appears, and then press **Enter**.
- 2 Press **▶** until **Align Cartridge** appears, and then press **Enter**.
Two pages are printed, one with instructions and one with patterns.
- 3 Follow the instructions on the instruction page, then place the page with patterns on the glass and press **Start Scan**.
The cartridges are aligned correctly.

clean the print cartridges

Use this feature when the Self-Test Report shows streaking or white lines through any of the colored bars. Do not clean print cartridges unnecessarily. This wastes ink and shortens the life of the ink nozzles.

- 1 Press **Setup** until **Maintenance** appears, and then press **Enter**.
- 2 Press **▶** until **Clean Cartridge** appears, and then press **Enter**.
If copy or print quality still seem poor after you clean the print cartridges, replace the print cartridge that is affected.

restore factory defaults



You can restore the original factory settings to what they were when you purchased your HP PSC. You can perform this process from the front panel only.

- 1 Press **Setup** until **Maintenance** appears, and then press **Enter**.
- 2 Press **▶** until **Restore Defaults** appears, and then press **Enter**.
The factory default settings are restored.

set the power save time



The bulb in your HP PSC remains on for a specified period so that the unit is immediately ready to respond to your request. When the HP PSC has not been used within that specified period, it turns the bulb off to preserve power and displays **Power Save On** in the front-panel display. (You can exit this mode by pressing any button on the front panel.)

Your unit is automatically set to enter power-save mode after 12 hours. Follow these steps if you want the HP PSC to enter this mode earlier.

- 1 Press **Setup** until **Maintenance** appears, and then press **Enter**.
- 2 Press  until **Power Save Time** appears, and then press **Enter**.
- 3 Press  until the desired time appears, then press **Enter**.



set scroll speed

The **Scroll Speed** option lets you control the rate that text messages appear in the front-panel display. You can choose **Normal**, **Fast**, or **Slow**.

- 1 Press **Setup** until **Maintenance** appears, and then press **Enter**.
- 2 Press  until **Scroll Speed** appears, and then press **Enter**.
- 3 Press  until the desired speed appears, then press **Enter**.

set the prompt delay time

The **Prompt Delay** option lets you control the amount of time before a message is displayed in the front-panel display. You can choose **Normal**, **Fast**, or **Slow**.

- 1 Press **Setup** until **Maintenance** appears, and then press **Enter**.
- 2 Press  until **Prompt Delay** appears, and then press **Enter**.
- 3 Press  until the delay time appears, then press **Enter**.

setup menu options

The following options are available from the **Setup** button.

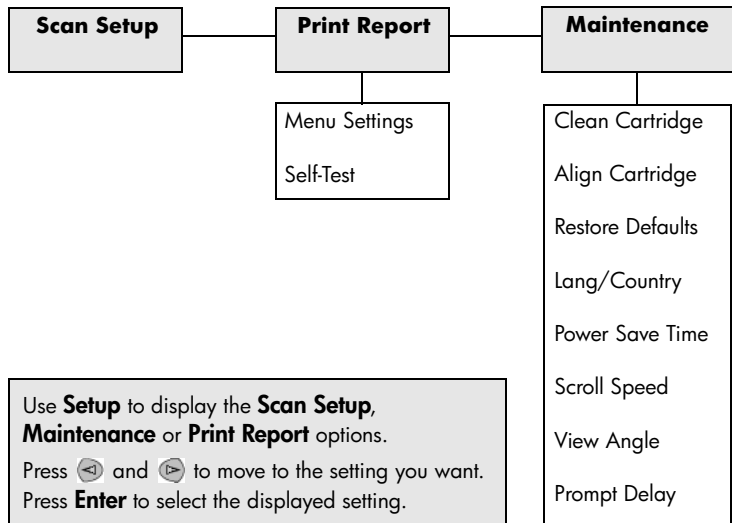

additional setup information

7

This section covers how to handle messages that may or may not appear during installation, how to set up the connection between your computer and your HP PSC, and how to add and remove the HP PSC software. The standard installation instructions are provided in your Setup Poster, which you should keep for later use.

possible installation problems

If you follow the instructions in the Setup Poster correctly, you should not have any problems with the installation of your HP PSC. If you do not follow the instructions, you may see any of the following problems:

If Microsoft's New Hardware Found message does not appear

If you installed the HP PSC software first as requested on the Setup Poster, and you are a Windows 98/2000/ME/XP user, a series of Microsoft New Hardware Found messages should have appeared on your screen after software installation and after the HP PSC was connected to your computer.

If the Microsoft messages did not appear, try the following:

- Verify that you are using a full-speed (12 Mbps) USB cable and that it does not exceed three meters in length (9.8 feet).
- Verify that the computer is USB-ready. For more information about determining whether your computer is USB-ready, see your computer's documentation or check with the computer's manufacturer.
- Verify that the cable is plugged fully into your HP PSC and directly connected to the USB port on your computer. After the cable is connected properly, turn your HP PSC off and then on again.
- Turn your HP PSC off and then on again, then restart your computer.
- If the previous steps do not solve the problem, remove and reinstall the software. For more information, see **remove and reinstall your hp psc software** on page 37.

If the New Hardware Message appears (Windows 98, 2000, ME, or XP)

If you set up your HP PSC and connect it directly to your computer *before* you install the software, you may encounter one of the following messages:

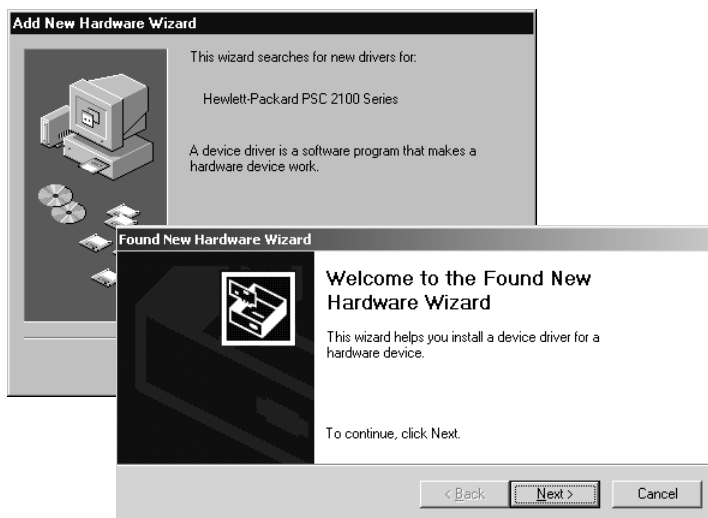

To avoid errors, install the HP PSC software before you connect the HP PSC to your computer. If one of the above messages appeared *and* you clicked **Next** or **OK**, do the following:

- 1 Press **Esc** on your keyboard to exit.
- 2 Turn off your HP PSC.
- 3 Disconnect the HP PSC from your computer (detach the USB cable).
- 4 Follow the software installation steps outlined in the Setup Poster that came with your HP PSC.

If the previous version installed message appears

If you receive a message that you have a previously installed version, you will not be able to finish installing the HP PSC software.

You will have to uninstall the previously installed version in order to install the HP PSC software.

If your computer is unable to communicate with your HP PSC





If communication cannot be established between your computer and HP PSC (for example, the HP PSC status icon has the yellow error triangle), try the same tasks outlined under **If Microsoft's New Hardware Found message does not appear** on page 33.



You may also want to refer to the readme file for more information on possible installation problems. On Windows, you can access the readme file from the Start button on the taskbar; select **Programs, Hewlett-Packard, hp psc 2000 series, View the Readme File**. On Macintosh, you can access the readme file by double-clicking on the icon located in the top-level folder of the HP PSC software CD-ROM.



set the language and region

Usually, the language and region are set when you install the HP PSC. If you set the region or language incorrectly during installation, use the following procedure.

- 1 If you are unable to read the front-panel display language, but need to access the maintenance function to reset it, press and hold **Enter** and then press .
- 2 Press **Setup** until **Maintenance** appears, and then press **Enter**.
- 3 Press  until **Lang/Region** appears, and then press **Enter**.
- 4 Press  until the desired language appears.
- 5 Press **Enter** when the desired language appears.
- 6 After the language is selected, you are prompted with all the regions for that selected language.
- 7 Press  until the desired region appears.
- 8 Press **Enter** to select the desired region.
You can confirm the region and language by printing a Self-Test Report.
- 9 Press **Setup** until **Print Report** appears, then press **Enter**.
- 10 Press  until **Self-Test** appears, then press **Enter**.

set the front-panel view angle

If you have difficulty seeing the text in the front-panel display, you may need to change the view angle. The **View Angle** option lets you control the viewing angle of the text in the front-panel display. You can change the angle so that it displays text best when you view it from a standing position or from a seated position.

- 1 Press **Setup** until **Maintenance** appears, and then press **Enter**.
- 2 Press  until **View Angle** appears, and then press **Enter**.
- 3 Press  until the desired angle appears, then press **Enter**.

connect your hp psc to your computer

Your HP PSC supports HOT Swapping, meaning you can connect to the HP PSC while the power is on at your computer and on the HP PSC.

connect your usb port

Connecting to your HP PSC with USB is straightforward. Simply plug one end of the USB cable into the back of your computer and the other in the back of the HP PSC.

what works	what does not work
Plugging into the USB port on your computer	Plugging into the USB port located on the keyboard
Plugging into a powered hub that is connected to the USB port on your computer	Plugging into a non-powered USB hub



AppleTalk is not supported.

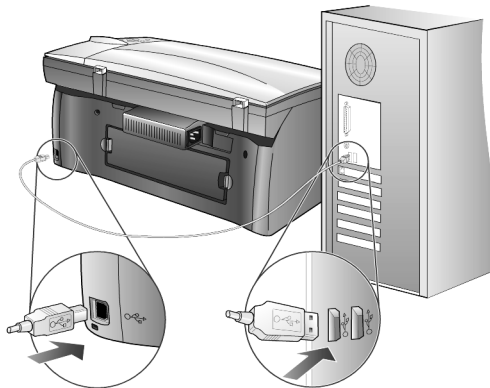

connecting to the USB port on your computer

connect your hp psc to more than one computer

You can connect more than one computer to your HP PSC by using a powered hub. Both computers must have the HP PSC software installed. Connect each computer to the hub, then connect the hub to the HP PSC.

If you want to connect more than one computer to your HP PSC in a networked environment, you can do so using an HP JetDirect 175x and USB (Windows and Macintosh), but only print functionality will be available for the HP PSC.

To use your HP PSC in a networked environment, you must install the software that comes with the HP JetDirect 175x, which disables all HP PSC functionality except printing.



If you have already installed the HP PSC software, uninstall that software, then install the HP JetDirect 175x software.

If you have Internet access, you can get more information on using an HP JetDirect 175x from the HP website at:

www.officejetsupport.com



You can have up to 10 client computers on the network portion of the 175x and USB combination.

remove and reinstall your hp psc software

Do *not* simply delete the HP PSC program files from your hard drive. Be sure to remove them properly using the uninstall utility provided in the HP PSC program group.

to uninstall from a Windows computer

- 1 On the Windows taskbar, click **Start**, choose **Programs** or **All Programs** (XP), choose **Hewlett-Packard**, choose **hp psc 2000 series**, then choose **uninstall software**.
- 2 Follow the directions on the screen.
- 3 If you are asked whether you would like to remove shared files, click **No**.
Other programs that use these files may not work properly if the files are deleted.
- 4 After the program finishes removing the software, disconnect your HP PSC, and restart your computer.
- 5 To reinstall the software, insert the HP PSC 2100 Series CD-ROM into your computer's CD-ROM drive, and follow the instructions that appear.
- 6 After the software is installed, connect and turn on your HP PSC.

to uninstall from a Macintosh computer

- 1 Double-click on **Applications:HP All-in-One Software** folder.
- 2 Double-click on **Uninstaller**.
- 3 Follow the directions that appear on the screen.

- 4 After the program finishes removing the software, disconnect your HP PSC, and restart your computer.
- 5 To reinstall the software, insert the HP PSC 2100 Series CD-ROM into your computer's CD-ROM drive, and follow the instructions that appear.



When re-installing the software, follow the instructions on the Setup Poster. Do not connect the HP PSC to your computer until after you have completed the software installation.

technical information

8

system requirements

The following specifications are subject to change without notice.

PC Requirements		
Item	Minimum	Recommended
Processor Windows 98 Windows 98SE Windows 2000 Windows Millennium Edition Windows XP	Any Intel Pentium II, Celeron, or compatible processor	Intel Pentium III or higher
RAM Windows 98 Windows 98SE Windows 2000 Windows Millennium Edition Windows XP	64 MB	128 MB or more
Disk space needed for installation	300 MB	
Additional disk space needed for scanned images	50 MB	
Monitor	SVGA 800 x 600 with 16-bit color	
Media	CD-ROM drive	
I/O	Available USB port	
Internet access		Recommended
Sound card		Recommended
Other	I.E. 5.0 or higher Adobe Acrobat 4 or higher	

Macintosh Requirements		
Item	Minimum	Recommended
Processor	G3 Processor	G4 Processor or higher

Macintosh Requirements		
Item	Minimum	Recommended
RAM Macintosh OS 9 Macintosh OS X	64 MB 128 MB	128 MB 256 MB
Disk space needed for installation	200 MB	
Additional disk space needed for scanned images	50 MB	
Monitor	SVGA 800 x 600	
Media	CD-ROM drive	
I/O	Available USB port	
Internet access		Recommended
Sound card		Recommended

paper specifications

paper-tray capacities

type	paper weight	input tray^a	output tray^b
Plain paper	16 to 24 lb. (60 to 90 gsm)	100	50 black, 20 color
Legal paper	20 to 24 lb. (75 to 90 gsm)	100	50 black, 20 color
Cards	110 lb. index max (200 gsm)	40	40
Envelopes	20 to 24 lb. (75 to 90 gsm)	15	10
Banners	16-24 lb. (60-90 gsm)	20	20 or less
Transparency film	N/A	25	25 or less
Labels	N/A	20	20
4x6 Photo	145 lb. (236 gsm)	30	30

^a Maximum capacity

^b Output tray capacity is affected by the type of paper and the amount of ink you are using. HP recommends emptying the tray frequently.

paper sizes

Type	Size
Paper	Letter: 8.5 x 11 in. (215.9 x 279.4 mm) Legal: 8.5 x 14 in. (215.9 x 355.6 mm) Executive: 7.25 x 10.5 in. (184.2 x 266.7 mm) A4: 210 x 297 mm A5: 148 x 210 mm B5: 182 x 257 mm
Banner	Letter: 8.5 x 11 in. (216 x 279 mm) A4: 8.27 x 11.69 in. (210 x 297 mm)

Type	Size
Envelopes	U.S. #10: 4.12 x 9.5 in. (104.8 x 241.3 mm) A2: 4.37 x 5.75 in. (111 x 146 mm) DL: 4.33 x 8.66 in. (110 x 220 mm) C6: 4.49 x 6.38 in. (114 x 162 mm)
Transparency films	Letter: 8.5 x 11 in. (216 x 279 mm) A4: 210 x 297 mm
Cards	3 x 5 in. (76.2 x 127 mm) 4 x 6 in. (101.6 x 152 mm) 5 x 8 in. (127 x 203.2 mm) A6: 105 x 148.5 mm hagaki card: 100 x 148 mm
Labels	Letter: 8.5 x 11 in. (216 x 279 mm) A4: 210 x 297 mm
Custom	3 x 5 in. up to 8.5 x 14 in. (76.2 x 127 mm up to 216 x 356 mm)

print specifications

- 1200 x 1200 dpi black with resolution enhancement technology (REt)
- 1200 x 1200 dpi color with HP PhotoREt III
- Method: Drop-on-demand thermal inkjet
- Language: HP PCL Level 3, PCL3 GUI or PCL 10
- Print speeds vary according to the complexity of the document.
- Duty cycle: 500 printed pages per month (average)
- Duty cycle: 3000 printed pages per month (maximum)

mode		resolution (dpi)	speed (ppm)	
			psc 2100 series	psc 2200 series
Best/inkjet/1200	Black	1200 x 1200	2	2
	Color	1200 x 1200 (up to 4800 dpi optimized ^a)	.5	.5
Normal	Black	600 x 600	6	7
	Color	600 x 600	3.5	4
Everyday	Black	600 x 600	7	8
	Color	600 x 600	5	6
Fast	Black	300 x 300	up to 14.0	up to 17.0
	Color	300 x 300	up to 10.0	up to 12.0

^a Up to 4800 x 1200 optimized dpi color printing on premium photo papers, 1200 x 1200 input dpi.

print margin specifications

	Top (leading edge)	Bottom (trailing edge) ^a	Left	Right
Sheet Paper				

	Top (leading edge)	Bottom (trailing edge) ^a	Left	Right
U.S. letter	.07 in. (1.8 mm)	.46 in. (11.7 mm)	.25 in. (6.4 mm)	.25 in. (6.4 mm)
U.S. legal	.07 in. (1.8 mm)	.46 in. (11.7 mm)	.25 in. (6.4 mm)	.25 in. (6.4 mm)
U.S. executive	.07 in. (1.8 mm)	.46 in. (11.7 mm)	.25 in. (6.4 mm)	.25 in. (6.4 mm)
ISO A4	.07 in. (1.8 mm)	.46 in. (11.7 mm)	.13 in. (3.4 mm)	.13 in. (3.4 mm)
ISO A5	.07 in. (1.8 mm)	.46 in. (11.7 mm)	.13 in. (3.4 mm)	.13 in. (3.4 mm)
JIS B5	.07 in. (1.8 mm)	.46 in. (11.7 mm)	.13 in. (3.4 mm)	.13 in. (3.4 mm)
Envelopes				
U.S. No. 10	.13 in. (3.2 mm)	.46 in. (11.7 mm)	.13 in. (3.2 mm)	.13 in. (3.2 mm)
A2 (5.5 baronial)	.13 in. (3.2 mm)	.46 in. (11.7 mm)	.13 in. (3.2 mm)	.13 in. (3.2 mm)
Intl. DL	.13 in. (3.2 mm)	.46 in. (11.7 mm)	.13 in. (3.2 mm)	.13 in. (3.2 mm)
Intl. C6	.13 in. (3.2 mm)	.46 in. (11.7 mm)	.13 in. (3.2 mm)	.13 in. (3.2 mm)
Cards				
U.S. 3 x 5 in.	.07 in. (1.8 mm)	.46 in. (11.7 mm)	.13 in. (3.2 mm)	.13 in. (3.2 mm)
U.S. 4 x 6 in.	.07 in. (1.8 mm)	.46 in. (11.7 mm)	.13 in. (3.2 mm)	.13 in. (3.2 mm)
U.S. 5 x 8 in.	.07 in. (1.8 mm)	.46 in. (11.7 mm)	.13 in. (3.2 mm)	.13 in. (3.2 mm)
ISO and JIS A6	.07 in. (1.8 mm)	.46 in. (11.7 mm)	.13 in. (3.2 mm)	.13 in. (3.2 mm)
Hagaki	.07 in. (1.8 mm)	.46 in. (11.7 mm)	.13 in. (3.2 mm)	.13 in. (3.2 mm)

^a This margin is not LaserJet-compatible, however, the total writing area is compatible. The writing area is offset from center by .21 inches (5.4 mm), which causes asymmetric top and bottom margins.

copy specifications

- Digital image processing
- Up to 99 copies from original (varies by model)
- Digital zoom from 25 to 400% (varies by model)
- Fit to page, Poster, Many on page
- Up to 17 cpm black, 12 cpm color (varies by model)
- Copy speeds vary according to the complexity of the document

mode		speed (ppm)		print resolution (dpi)	scan resolution (dpi) ^a
		psc 2100	psc 2200		
Best	Black	up to 0.8	up to 0.8	1200 x 1200 ^b	1200 x 2400
	Color	up to 0.8	up to 0.8	1200 x 1200 ^b	1200 x 2400
Normal	Black	up to 6	up to 7	600 x 1200	600 x 1200
	Color	up to 2	up to 4	600 x 600	600 x 1200
Fast	Black	up to 14	up to 17	300 x 1200	600 x 1200
	Color	up to 10	up to 12	600 x 300	600 x 1200

- a Maximum at 400% scaling
- b On photo paper or premium inkjet paper

scan specifications

- Create photo projects
- Image editor included
- OCR software automatically converts to editable text
- Scan speeds vary according to the complexity of the document

Item	Description	
	psc 2100 series	psc 2200 series
Resolution	600 x 1200 dpi optical, up to 9600 dpi enhanced	1200 x 2400 dpi optical, up to 9600 dpi enhanced
Color	48-bit color 8-bit grayscale (256 levels of gray)	48-bit color 8-bit grayscale (256 levels of gray)
Interface	TWAIN-compliant	TWAIN-compliant
Scanning Area	US Letter, A4	US Letter, A4

physical specifications

- Height: 8.7 in. (22 cm)
- Width: 18.2 in. (46.3 cm)
- Depth: 14.6 in. (37 cm)
- Weight: 17.25 lb. (7.82 kg)

power specifications

- Power consumption: 75W maximum
- Source (Input) Voltage: 100 to 240 VAC, grounded
- Input Frequency: 50 to 60 Hz
- Current: 1.0 A maximum

environmental specifications

- Recommended Operating Temperature Range: 15° to 32° C (59° to 90° F)
- Allowable Operating Temperature Range: 5° to 40° C (41° to 104° F)
- Humidity: 15% to 85% RH non-condensing
- Non-operating (Storage) Temperature Range: -40° to 60° C (-40° to 140° F)

additional specifications

- Memory: 8.0-MB ROM, 8.0-MB RAM (psc 2100 series)
- Memory: 8.0-MB ROM, 16.0-MB RAM (psc 2200 series)

If you have Internet access, you can get acoustic information from the HP website at:

www.officejetsupport.com

environmental product stewardship program

protecting the environment

Hewlett-Packard is committed to providing quality products in an environmentally sound manner. This product has been designed with several attributes to minimize impacts on our environment.

For more information, visit HP's Commitment to the Environment website at:

www.hp.com/abouthp/environment

ozone production

This product generates no appreciable ozone gas (O₃).

paper use

This product is suited for the use of recycled paper according to DIN 19309.

plastics

Plastic parts over 25 grams are marked according to international standards that enhance the ability to identify plastics for recycling purposes at the end of the product's life.

recycling program

HP offers an increasing number of product return and recycling programs in many countries, as well as partnering with some of the largest electronic recycling centers throughout the world. HP also conserves resources by refurbishing and reselling some of its most popular products.

energy consumption

Energy usage drops significantly while in Power Save mode, which saves natural resources, and saves money without affecting the high performance of this product. This product qualifies for ENERGY STAR®, which is a voluntary program established to encourage the development of energy-efficient office products.



ENERGY STAR is a U.S. registered service mark of the U.S. EPA. As an ENERGY STAR partner, HP has determined that this product meets ENERGY STAR guidelines for energy efficiency.

For more information on ENERGY STAR guidelines, visit the following web site:

www.energystar.gov

material safety data sheets

Material safety data sheets (MSDS) can be obtained from the HP web site at:

www.hp.com/go/msds

If you are in the United States or Canada and do not have access to the Internet, call the U.S. HP FIRST fax-on-demand service at (800) 231-9300. Use Index number 7 for a listing of the material safety data sheets.

International customers without Internet access should call (404) 329-2009 for further information.

regulatory notices

The following sections are statements from various regulatory agencies.

FCC statement

The United States Federal Communications Commission (in 47 CFR 15.105) has specified that the following notice be brought to the attention of users of this product.

Declaration of Conformity: This equipment has been tested and found to comply with the limits for a Class B digital device, pursuant to part 15 of the FCC Rules. Operation is subject to the following two conditions: (1) this device may not cause harmful interference, and (2) this device must accept any interference received, including interference that may cause undesired operation. Class B limits are designed to provide reasonable protection against harmful interference in a residential installation. This equipment generates, uses, and can radiate radio frequency energy, and, if not installed and used in accordance with the instructions, may cause harmful interference to radio communications. However, there is not guarantee that interference will not occur in a particular installation. If this equipment does cause harmful interference to radio or television reception, which can be determined by turning the equipment off and on, the user is encouraged to try to correct the interference by one or more of the following measures:

- Reorient the receiving antenna.
- Increase the separation between the equipment and the receiver.
- Connect the equipment into an outlet on a circuit different from that to which the receiver is connected.
- Consult the dealer or an experienced radio/TV technician for help.

Product Regulations Manager, Hewlett-Packard Company, San Diego, (858) 655-4100.

The user may find the following booklet prepared by the Federal Communications Commission helpful: *How to Identify and Resolve Radio-TV Interference Problems*. This booklet is available from the U.S. Government Printing Office, Washington DC, 20402. Stock No. 004-000-00345-4.

Caution! Pursuant to Part 15.21 of the FCC Rules, any changes or modifications to this equipment not expressly approved by the Hewlett-Packard Company, may cause harmful interference and void the FCC authorization to operate this equipment.

**doc statement /
déclaration de
conformité
(Canada)**

Le présent appareil numérique n'émet pas de bruit radioélectrique dépassant les limites applicables aux appareils numériques de la classe B prescrites dans le Règlement sur le brouillage radioélectrique édicté par le ministère des Communications du Canada.

This digital apparatus does not exceed the Class B limits for radio noise emissions from digital apparatus set out in the Radio Interference Regulations of the Canadian Department of Communications.

declaration of conformity

According to ISO/IEC Guide 22 and EN 45014

Manufacturer's Name and Address:

Hewlett-Packard Company, 16399 West Bernardo Drive, San Diego, CA 92127-1899, USA

declares that the product

Product Name: hp psc 2100 series (C8644A)
Model Number(s): psc 2110 (C8648A), psc 2110xi (C8649A), psc 2110v (C8650A), psc 2105 (C8647A)
Product Options: All

conforms to the following Product Specifications:

Safety: EN60950:1992 +A1, A2, A3, A4 & A11
IEC60950:1991 +A1, A2, A3 & A4
UL1950/CSA 22.2 No. 950, 3rd Edn: 1995
NOM-019-SCFI-1993
IEC 60825-1:1993 +A1/EN 60825-1:1994 +A11 Class 1 (Laser/LED)

EMC: CISPR22:1993 +A1 & A2 / EN55022:1994, +A1 & A2 -Class B
CISPR24:1997/EN55024:1998
IEC 61000-3-2:1995 / EN61000-3-2:1995
IEC 61000-3-3:1994 / EN61000-3-3:1995
AS/NZS 3548: 1992
CNS13438
FCC Part 15-Class B / ICES-003, Issue 2 / VCCI-2
GB 9254-1998

Supplementary Information

The Product herewith complies with the requirements of the Low Voltage Directive 73/23/EEC, and the EMC Directive 89/336/EEC carries the CE marking accordingly.

European Contact for regulatory topics only: Your local Hewlett-Packard Sales and Service Office or Hewlett-Packard GmbH.

Department HQ-TRE, Herrenberger Strasse 130, D-71034 Böblingen, Germany (FAX + 49-7031-14-3143)

get hp psc 2100 support

9

This section explains the service information provided by Hewlett-Packard. If you are unable to find the answer you need in the printed or onscreen documentation supplied with your product, you can contact one of the HP support services listed in the following pages.

get support and other information from the internet

If you have Internet access, you can get more information from the HP website at: www.officejetsupport.com

The website offers technical support, drivers, supplies, and ordering information.

hp customer support

Software programs from other companies may be included with your HP PSC. If you experience problems with any of those programs, you will receive the best technical assistance by calling the experts at that company.

If you need to contact HP Customer Support, do the following before you call.

- 1 Make sure that:
 - a. Your unit is plugged in and turned on.
 - b. The specified print cartridges are installed correctly.
 - c. The recommended paper is properly loaded in the input tray.
- 2 Reset your unit:
 - a. Turn off the unit using the **On** button located on the unit's front panel.
 - b. Unplug the power cord from the back of the unit.
 - c. Plug the power cord back into the unit.
 - d. Turn on the unit using the **On** button.
- 3 For more information, see the HP website at: www.officejetsupport.com
- 4 If you are still experiencing problems and need to speak with an HP Customer Support Representative:
 - Have your serial number and service ID ready. To display your serial number, on the front panel, press **Enter** and **Start Copy, Black** at the same time, until the serial number appears in the front-panel display. To

display your service ID, on the front panel, press **Enter** and **Start Copy, Color** at the same time, until **SERV ID:** and the number appear in the front-panel display

- Print a Self-Test Report. See **print a self-test report** on page 26 for information on printing this report.
- Make a color copy.
- Be prepared to describe your problem in detail.

5 Call HP Customer Support. Be near your unit when you call.

call in the U.S. during warranty

Call (208) 323-2551 Monday through Friday from 6:00 A.M. to 10:00 P.M. Mountain Standard Time (MST) and Saturdays from 9:00 A.M. to 4:00 P.M. MST. This service is free during the warranty period; however, your standard long-distance phone charges still apply. A fee may apply outside the warranty period.

prepare your unit for shipment

If after contacting HP Customer Support or returning to the point of purchase, you are requested to send your unit in for service, please follow the power off and rebox steps below to avoid further damage to the HP product.

- 1 Turn on the unit.
Disregard steps 1 through 6, if your unit will not turn on and the print carriage is in the home position. You will not be able to remove the ink cartridges. Proceed to step 7.
- 2 Open the print-carriage access door.
- 3 Remove the print cartridges from their holders, and lower the latches.
Caution! Remove both print cartridges and lower both latches. Failure to do so may damage your unit.
See **replace the print cartridges** on page 27 for information on removing the print cartridges.
- 4 Place the print cartridges in an airtight bag so they will not dry out, and put them aside (do not send them with the unit, unless instructed to by the HP customer support call agent).
- 5 Turn off the unit.
- 6 Close the print-carriage access door.
- 7 Remove the front panel cover as follows:
 - a. Insert a small screw driver into the top right corner of the front panel cover.
 - b. Gently pry the corner up and lift the front panel cover from the unit.

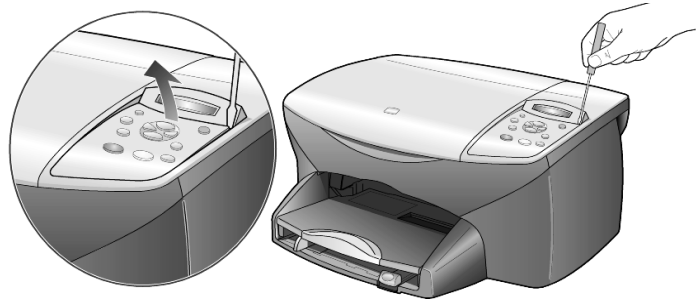

- 8 Retain the front panel cover. Do not return the front panel cover with the unit.
- 9 If available, pack the unit for shipment using the original packing materials or the packaging materials that come with your exchange unit.

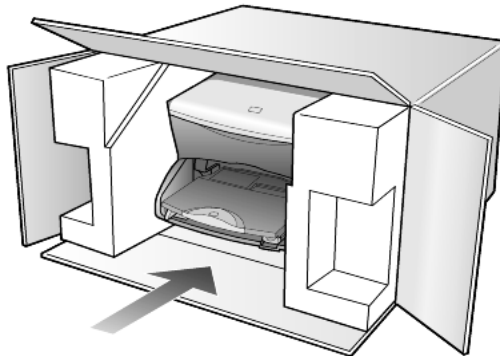

If you do not have the original packaging materials, please use other adequate packaging materials. Shipping damage caused by improper packaging and/or improper transportation is not covered under the warranty.

- 10 Place the return shipping label on the outside of the box.
- 11 Include the following items in the box:
 - A brief description of symptoms for service personnel (samples of print quality problems are helpful).
 - A copy of the sales slip or other proof of purchase to establish the warranty coverage period.
 - Your name, address, and a phone number where you can be reached during the day.

hp distribution center

To order HP PSC software, a copy of the printed Reference Guide, a setup poster, or other customer-replaceable parts, do one of the following:

- In the U.S. or Canada, call (208) 323 2551.
- Visit this website:

https://warp2.external.hp.com/Driver/dr_country_select.asp

warranty information

10

hp psc 2100 series

Duration of Limited Warranty (hardware and labor): 1 Year

Duration of Limited Warranty (CD media): 90 Days

Duration of Limited Warranty (ink cartridges): 90 Days

warranty service

express service

To obtain HP express repair service, the customer must contact an HP service office or an HP Customer Support Center for basic troubleshooting first. See **hp customer support** on page 47 for steps to take before calling Customer Support.

If a customer unit needs a minor part replacement and these parts can normally be replaced by the customer, the customer-replaceable components may be serviced through expedited part shipment. In this event, HP will prepay shipping charges, duty and taxes; provide telephone assistance on replacement of the component; and pay shipping charges, duty, and taxes for any part that HP asks to be returned.

The HP Customer Support Center may direct customers to designated authorized service providers who are certified by HP to service the HP product.

warranty upgrades

Upgrade your standard factory warranty to a total of three years with the HP SUPPORTPACK. Service coverage begins on product purchase date and the pack must be purchased within the first 180 days of product purchase. This program offers phone support from 6:00 A.M. to 10:00 P.M. Mountain Standard Time (MST) Monday through Friday and 9:00 A.M. to 4:00 P.M. (MST) on Saturdays. If during your technical support call it is determined that you need a replacement product, then HP will ship you this product next business day free of charge. Available in U.S. only.

For more information, please call 1-888-999-4747 or visit the following HP website:
www.hp.com/go/hpsupportpack

returning your hp psc 2100 series for service

Before returning your HP PSC for service, you must call HP Customer Support. See **hp customer support** on page 47 for steps to take before calling Customer Support.

hewlett-packard limited global warranty statement

extent of limited warranty

Hewlett-Packard (“HP”) warrants to the end-user customer (“Customer”) that each HP PSC 2100 Series product (“Product”), including related software, accessories, media, and supplies, shall be free from defects in material and workmanship for the duration, which begins on the date of purchase by the Customer.

For each hardware Product, the duration of HP’s limited warranty is one year for parts and one year for labor. For all other Products, the duration of HP’s limited warranty for both parts and labor is ninety days.

For each software Product, HP’s limited warranty applies only to a failure to execute programming instructions. HP does not warrant that the operation of any Product shall be uninterrupted or error free.

HP’s limited warranty covers only those defects which arise as a result of normal use of a Product, and does not cover any other problems, including those which arise as a result of (a) improper maintenance or modification, (b) software, accessories, media, or supplies not provided or supported by HP, or (c) operation outside the Product’s specifications.

For any hardware Product, the use of a non-HP ink cartridge or a refilled ink cartridge does not affect either the warranty to the Customer or any HP support contract with the Customer. However, if Product failure or damage is attributable to the use of a non-HP or refilled ink cartridge, HP shall charge its standard labor and materials charges to service the Product for the failure or damage.

If HP receives, during the applicable warranty period, notice of a defect in any Product, HP shall either repair or replace the defective Product, at HP’s option. Where labor charges are not covered by HP’s limited warranty, repairs shall be at HP’s standard charges for labor.

If HP is unable to repair or replace, as applicable, a defective Product which is covered by HP’s warranty, HP shall, within a reasonable time after being notified of the defect, refund the purchase price for the Product.

HP shall have no obligation to repair, replace, or refund until the Customer returns the defective Product to HP.

Any replacement product may be either new or like-new, provided that it has functionality at least equal to that of the Product being replaced.

HP products, including each Product, may contain remanufactured parts, components, or materials equivalent to new in performance.

HP’s limited warranty for each Product is valid in any country or locality where HP has a support presence for the Product and where HP has marketed the Product. The level of warranty service may vary according to local standards. HP shall have no obligation to alter the form, fit, or function of the Product in order to make it operate in a country or locality for which the Product was never intended to operate.

limitations of warranty

TO THE EXTENT ALLOWED BY LOCAL LAW, NEITHER HP NOR ITS THIRD PARTY SUPPLIERS MAKE ANY OTHER WARRANTY OR CONDITION OF ANY KIND, WHETHER EXPRESS OR IMPLIED, WITH RESPECT TO THE COVERED HP PRODUCTS, AND SPECIFICALLY DISCLAIM THE IMPLIED WARRANTIES OR CONDITIONS OF MERCHANTABILITY, SATISFACTORY QUALITY, AND FITNESS FOR A PARTICULAR PURPOSE.

limitations of liability

To the extent allowed by local law, the remedies provided in this Limited Warranty Statement are the Customer’s sole and exclusive remedies.

TO THE EXTENT ALLOWED BY LOCAL LAW, EXCEPT FOR THE OBLIGATIONS SPECIFICALLY SET FORTH IN THIS LIMITED WARRANTY STATEMENT, IN NO EVENT SHALL HP OR ITS THIRD PARTY SUPPLIERS BE LIABLE FOR DIRECT, INDIRECT, SPECIAL, INCIDENTAL, OR CONSEQUENTIAL DAMAGES, WHETHER BASED ON CONTRACT, TORT, OR ANY OTHER LEGAL THEORY AND WHETHER ADVISED OF THE POSSIBILITY OF SUCH DAMAGES.

local law

This Limited Warranty Statement gives the Customer specific legal rights. The Customer may also have other rights which vary from state to state in the United States, from province to province in Canada, and from country to country elsewhere in the world.

To the extent this Limited Warranty Statement is inconsistent with local law, this Statement shall be deemed modified to be consistent with such local law. Under such local law, certain disclaimers and limitations of this Statement may not apply to the Customer. For example, some states in the United States, as well as some governments outside the United States (including provinces in Canada), may:

Preclude the disclaimers and limitations in this Statement from limiting the statutory rights of a consumer (e.g. the United Kingdom);

Otherwise restrict the ability of a manufacturer to enforce such disclaimers or limitations; or
Grant the Customer additional warranty rights, specify the duration of implied warranties which the manufacturer cannot disclaim, or not allow limitations on the duration of implied warranties.
FOR CONSUMER TRANSACTIONS IN AUSTRALIA AND NEW ZEALAND, THE TERMS IN THIS LIMITED WARRANTY STATEMENT, EXCEPT TO THE EXTENT LAWFULLY PERMITTED, DO NOT EXCLUDE, RESTRICT, OR MODIFY, AND ARE IN ADDITION TO, THE MANDATORY STATUTORY RIGHTS APPLICABLE TO THE SALE OF THE COVERED HP PRODUCTS TO SUCH CUSTOMERS.

index

Numerics

4-by-6 inch photo paper, load **11, 13**

A

adjust settings
copy **17**
view angle **35**
align cartridges **29**

B

banner paper
tips on loading **13**
best copy quality **16**
buttons
cancel **4**
copies (1-99) **4, 16**
front panel **3**
quality **4, 16**
start scan **4, 23**

C

cancel
button **4**
copy **21**
scan **24**
cartridges
align **29**
replace **27**
clean
print cartridges **29**
the exterior **26**
the glass **25**
the lid backing **25**
color
intensity of copy **17**
continuous paper
tips on loading **13**
contrast

enhance photo colors **17**
front-panel display **35**

copy

an original **19**
buttons **3**
change default settings **17**
color intensity **17**
darken **16**
defaults **17**
enhancements **17**
enlarge **16**
fit to page **18**
lighten **16**
make a poster **19**
make copies **15**
photo **18**
quality **4, 16**
reduce **16**
set number of copies **16**
several copies on a page **19**
special copy jobs **18**
speed **16**
stop **21**
T-shirt transfer **20**
country setup **35**
customer support **47**

D

darken a copy **16**
declaration of conformity **46**
default settings
change for copy **17**
restore factory defaults **29**
director review **4**

E

enhancements **17**

enlarge a copy **16, 18**

envelopes
load **10**

F

factory defaults
change for copying **17**
restore **29**

fast copy quality **16**

fit to page **18**

front panel
features **3**
scan from **23**
front-panel display **3**
scroll speed **30**
set language **35**
set view angle **35**

G

glass cleaning **25**
greeting cards, load **12**

H

hagaki cards
load **12**
size **41**
help **1**
hp customer support **47**
hp director **4–6**
hp distribution center **49**
hp papers, tips on loading **12**
hp photo & imaging gallery **24**
hp psc software **4**

I

ink cartridges, see print cartridges
inkjet paper, load **12**
intensity of color copy **17**
introduction
to the Director **4**
iron-on T-shirt transfers **20**

L

labels
load **12**
lamp power save mode **30**
language setup **35**
lid backing, clean **25**
light power save mode **30**
lighten or darken copies **16**
load
change the paper type **13**

envelopes **10**
hagaki cards **12**
original on the glass **7**
paper **8**
photo paper **11, 13**
postcards **11, 12**
print cartridges **27**
set the paper size **14**
tips **12**

M

maintenance
align cartridges **29**
clean print cartridges **29**
clean the exterior **26**
clean the glass **25**
clean the lid backing **25**
power save mode time **30**
replace print cartridges **27**
restore factory defaults **29**
self-test report **26**
menus
copy setup **21**
maintenance **31**
print reports **31**

N

normal copy quality **16**
number of copies **4**
set **16**

O

order print cartridges **59**
originals
how to place on glass **7**
multiple copies **19**
output tray **13**
extender **10**

P

paper
change default size for copy **13**
change the type **13**
load **8**
recommended **8**
set the size **14**
tips on loading **12–13**
paper size, change for copy **13**
paper tray, load **8**
phone numbers, support services **47**
photo mode enhancement **18**
photo paper, load **11, 13**

- photos
 - copy **18**
 - enhance copy **17**
- postcards, load **11, 12**
- poster
 - copy to **19**
- power save mode setup **30**
- power save mode time **30**
- print
 - continuous (banner) paper, tips on loading **13**
 - envelopes **10**
 - self-test report **26**
- print cartridge protector **27**
- print cartridges
 - align **29**
 - clean **29**
 - protector **27**
 - replace **27**
 - store **27**
- prompt delay, set **30**
- Q**
- quality **16**
- quick start
 - review the director **4**
 - use with a computer **4**
- R**
- reduce a copy **16, 18**
- regulatory information **44**
- reinstall software **37**
- remove software **37**
- reports
 - self-test **26**
- restore factory settings **29**
- returning your hp psc for service **51**
- S**
- save, a scanned image **23**
- scan
 - buttons **3**
 - different destination **24**
 - from front panel **23**
 - stop **24**
- scroll speed setup **30**
- self-test report **26**
- set
 - language and country **35**
 - number of copies **16**
 - power save mode **30**
 - prompt delay **30**
 - scroll speed **30**
 - view angle **35**
- settings
 - best copy quality **16**
 - copy a photo **18**
 - copy color intensity **17**
 - copy defaults **17**
 - copy quality **16**
 - copy speed **16**
 - country and language **35**
 - darken a copy **16**
 - enlarge a copy **16**
 - fast copy quality **16**
 - lighten a copy **16**
 - normal copy quality **16**
 - power save mode **30**
 - prompt delay **30**
 - reduce a copy **16**
 - save copy **17**
 - scroll speed **30**
 - text enhancement **17**
- setup
 - additional information **33**
- software
 - introduction **4**
 - remove and reinstall **37**
- specifications **41**
- stop
 - copy **21**
 - scan **24**
- support services **47**
- T**
- telephone numbers **47**
- text, enhance **17**
- transparency film
 - recommend choices **8**
 - tips on loading **12**
- troubleshooting, remove and reinstall software **37**
- T-shirt transfer **20**
 - load **12**
- tutorial
 - front panel features **3**
- U**
- USB cable installation **36**
- V**
- view angle, set **35**
- W**
- warranty **47**

hp psc 2100 series

service **51**
statement **52**

upgrades **51**

order supplies

Use the following information for ordering supplies for your HP PSC 2100 Series.

order media

To order media such as HP Premium Inkjet Paper, HP Premium Inkjet Transparency Film, HP Iron-On T-shirt Transfer paper, or HP Greeting Cards, see one of the following:

- For orders in the U.S. and Canada, go to www.hpshopping.com.
- For orders in all other countries, go to www.hpshopping.com. Select **other countries**, then click **Yes** to leave hpshopping.com. From this website, you can access hpshopping.com for your specific language or region.

order print cartridges

The following table lists the print cartridges that you can use with the HP PSC 2100 Series. Use the following information to determine which print cartridge to order.

print cartridges	hp reorder number
HP black print cartridge	#56, 19 ml black print cartridge
HP black print cartridge	#27, 10 ml black print cartridge
HP color print cartridge	#57, 17 ml color print cartridge
HP photo color print cartridge	#58, 17 ml color print cartridge
HP tricolor print cartridge	#28, 8 ml color print cartridge

If you have Internet access, you can get more information from the HP website at:

<http://www.officejetsupport.com>

Visit the hp psc information center

It has everything you need to get the most value from your HP PSC.

- Technical Support
- Supplies and Ordering Information
- Project Tips
- Ways to Enhance Your Product

www.officejetsupport.com

© 2002 Hewlett-Packard Company

Printed in the U.S.A., Mexico, Germany, Singapore, or China.



C8644-90213