

# TONER REFILL INSTRUCTIONS

---





## GENERAL INSTRUCTIONS – PLEASE READ BEFORE REFILLING

Thank you for purchasing a Uni-Kit toner refill kit. If you have any questions about the use of these products, please check our FAQ's below or email our technical support at support@uni-kit.com. Uni-Kit is dedicated to providing high quality products at prices that allow our customers to save significantly compared to buying original cartridges. Refilling your toner cartridge also helps the environment as your empty toner cartridge can be revived instead of landing up in a landfill.

The refilling procedure is simple in most cases – make a hole (or uncover a hole) in the cartridge, refill it, and seal it. For specific instructions on your specific model please locate your model in our instruction booklet. While refilling a toner cartridge poses no significant risk to your health, we ask you to refill outside whenever possible and always use common sense when handling the toner hole making tool or when pouring the toner.

### Using the toner hole making tool:



This tool is an electrical appliance that is used to make a hole in the cartridge by first heating up to a desired temperature. Be careful when handling this tool so that you don't burn yourself or anything around you, the tool gets very HOT! You will need to wait for the tool to heat up for about 3-5 minutes before using it to burn a hole in the desired location on the cartridge (see specific cartridge instructions for location of hole). While waiting for the tool to heat up or cool down, rest the tool on the tool stand as shown in this diagram above.

### Pouring the toner:

To our knowledge, the average DIY refiller's exposure to fumes presents no significant health hazard in normal use. We recommend refilling in a well ventilated room or outside to minimize the exposure to fumes. For extra protection, wear a dust mask.

## FAQ's FOR THE UNI-KIT TONER REFILL KITS

### 1. Will your toner harm my printer or photocopier?

If you follow our simple instructions and inspect your work before reinstalling your cartridge, there is no way the cartridge you refill can harm your machine.

### 2. Will the use of your toner void my warranty?

Nope! In fact, it is against the law (the Sherman and Clayton Anti-Trust Acts, to be specific) to tie the purchase or use of a particular supply to the warranty.

### 3. Are there any hazards involved with the handling of toner?

HP describes toner as "Toner is a nontoxic substance composed of plastic, iron, and a small amount of pigment."

Much like the fumes released from gasoline in cars or from active or passive smoking or even from inert dust and chemicals in the environment, the exposure to fumes from toner or from burning a hole in the cartridge (when necessary) could of course be hazardous. To our knowledge, the average DIY refiller's exposure to fumes presents no significant health hazard in normal use. We recommend refilling in a well ventilated room or outside to minimize the exposure to fumes. For extra protection, wear a dust mask.

### 4. How many times can I refill my toner cartridge?

An average of three times (It varies depending on cartridge type). The range is from 1 or 2 times, to 5 or more times. Quality and page yield will decrease the more times a cartridge is refilled. While we have had reports from some users that they have been able to use our toner an even greater number of times on a given empty, the simple (and obvious) rule of thumb is, continue to use our toner until you are no longer satisfied with the print quality.

### 5. Why are the kits named after formulas instead of names of printers?

The "engine" in your laser printer is also manufactured to be used in dozens, even hundreds of other printers.

Canon actually makes all of the Hewlett Packard laser printers and toner cartridges. Hewlett Packard does not make a single laser printer nor do they make a single toner cartridge.

### 6. If the refilled cartridge using your toner won't hurt the printer, what, if anything, can go wrong?

Just like a new cartridge, if there is ever anything that goes wrong, it normally shows up on the printed output. If you notice spots, dots, blank spots or voids showing up on the printed page (in a pattern that repeats several times down the page), then the cartridge has reached the end of its useful life and needs to be replaced. A razor sharp, pencil thin line appearing on the page also indicates a cartridge has reached the end of the line.

### 7. Is your toner made by the same company that makes the brand-name cartridge toner?

There is no way to know for sure. Many laser printer manufacturers do not make their own toner. We use toner formulas that match as closely as possible the properties of the original toner they are replacing. Our toners are tested not only for excellent quality prints like the original, but also for page yield so that you get about the same amount of printed pages as the original cartridge on the first refill.



# Monochrome Cartridges

(Cartridges are sorted by cartridge model)

## A

Apple - M0089	51
Apple - M0180	53
Apple - M2045GA	56
Apple - M2473A / G	31
Apple - M6002	52

## B

Brother - TN250	1
Brother - TN350	2
Brother - TN330/360	3
Brother - TN430/460/560	4
Brother - TN540/550/570/580	5
Brother - TN9500	35
Brother - TN9500(highyield)	36
Brother - TN650	5

## C

Canon - A30,A15	11
Canon - E16/E20/E31/E40	7
Canon - EP52	35
Canon - EP52(highyield)	36
Canon - EPA	32
Canon - EPB	50
Canon - EPC/A20	53
Canon - EPE	31
Canon - EPW/EP72	49
Canon - F100	10
Canon - FX1/EPL	51
Canon - FX2/EPP	56
Canon - FX3	32
Canon - FX4	30
Canon - FX5	31
Canon - L50	8
Canon - S35	9
Canon - X25	9
Canon - XS/EP5	52
Canon - FX8	12
Canon - FX9/FX10/104	13
Canon - Cartridge106	14

## D

DEC - LON0XXAA	31
DEC - LN07XAA	51
DEC - LN11XAA	29
Dell - 1100	18
Dell - S-35	15
Dell - P1500	16
Dell - P1600	17
Dell - 1700	19
Dell - M5200	80

## E

Epson - S0500100	28
Epson - S051016	29
Epson - S051011	29
Epson - S051009/S051200	27
Epson - S051023	26

## G

Genicom - 6A0133P01	
6A0134P01	82

## H

HP - CB435A	68
HP - 92274A	56
HP - 92275A	51
HP - 92285A	53
HP - 92291A	47
HP - 92295AX	52
HP - 92298A/X	31
HP - C3900A	50
HP - C3903A	30
HP - C3906A	32
HP - C3909A	67
HP - C4092A	33
HP - C4096A	34
HP - C4127A	35
HP - C4127X	36
HP - C4127AX/C4182AX	49
HP - C4129X	65
HP - Q6511A/X	72
HP - C7115A	37
HP - C7115X	38
HP - C8061A	54
HP - C8061X	39
HP - Q1338A/Q1339A	48
HP - Q2610A	40



# Monochrome Cartridges

(Cartridges are sorted by cartridge model)

## H

HP-Q2612A/X	41
HP-Q2613A/X	42
HP-2035/2055	74
HP-Q2624A	43
HP-Q5949A	46
HP-5942	69
HP-5200/M5025	73
HP-C7553A/C7553X	62
HP-C7551A/C7551X	63
HP-8543X	66
HP-CC364	45
HP-3015	44

## I

IBM Info Print 1312	16
IBM-63H5721	49

## K

Konica Minolta 4161101/1710434001	121
Konica Minolta 0910802/0910803	27
Konica Minolta - 0927605, 0927606	29
Konica Minolta - 17030190000	52
Konica Minolta - 17030210000	53

Konica Minolta - 1710081001	50
Konica Minolta - 1710433001/0938306	121
Konica Minolta - 171046601	
171046001	49
Konica Minolta - 1710497001	126
Konica Minolta - 1710511001,	
1410399002,	
1710405002,	
4152601/4152301	28
Konica Minolta 1300/1350	91
Konica Minolta 1400	92
Kyocera Mita TK-332 / TK-322 / TK-312	77

## L

Lexmark - 08A0477/08A0478	15
Lexmark - 10S0150	107
Lexmark - 1382100/1382150/	
1380850/1380950/	
1380200/1380520	82
Lexmark - 1382140	49
Lexmark - 1382760	78
Lexmark - 13T0101	84
Lexmark - 140100A	50
Lexmark - 140109A	83
Lexmark - 140195AX	52

Lexmark - 140198A / X	31
Lexmark - 17G0152, 17G0154,	
4K00198, 4K00199	
12A5740, 1382625,	
1382925, 1382929	
12A5745, 12A5840,	
12A5845, 12A5849	79
Lexmark E220/E321/E323	16
Lexmark T630/T632/T634/	
T640	80
Lexmark E120	19
Lexmark C910/C912/C920	86
Lexmark T420	89
Lexmark e250 / 350 / 450	90
Lexmark E230/E232/E238/E330	
E332/E340	19

## M

MURATEC/MURATA TS120	121
----------------------	-----

## N

NEC 20055	27
NEC 20090	121
NEC 20120 / 20122	28
NEC 20152	126
NEC S2526	121





# Monochrome Cartridges

(Cartridges are sorted by cartridge model)

## O

OKIDATA 52111401 \_\_\_\_\_ 121

## P

Panasonic – FQU160 \_\_\_\_\_ 27

PITNEY BOWES 8060 \_\_\_\_\_ 51

PITNEY BOWES 8186 \_\_\_\_\_ 121

## R

RICOH 339302 \_\_\_\_\_ 52

RICOH 339473 \_\_\_\_\_ 121

RICOH 339479 \_\_\_\_\_ 121

## S

Samsung ML 1710 \_\_\_\_\_ 106

Samsung ML6060 \_\_\_\_\_ 126

Samsung SF5100 / TDR510P  
ML4500 / ML1210 \_\_\_\_\_ 107

Samsung ML5000/TD55K \_\_\_\_\_ 84

Samsung ML-7000 \_\_\_\_\_ 115

Samsung ML-1510 / ML-2250,  
SCX-D4200A \_\_\_\_\_ 114

Samsung ML-2010, ML1610,  
SCX-4321 / SCX-4521 \_\_\_\_\_ 18

Samsung 3050 / 2850 / 2851 / 4826 \_\_\_\_\_ 117

Samsung ML2151 / ML2152 / ML2155 \_\_\_\_\_ 118

Samsung ML2550 / ML2551 / ML2552 \_\_\_\_\_ 118

Samaung ML1630 / SCX-4500 \_\_\_\_\_ 120

Sharp - AL100TD \_\_\_\_\_ 127

Sharp - FO45ND \_\_\_\_\_ 121

Sharp - Z781701, ZT50701 \_\_\_\_\_ 125

Sharp-ZT20TD1 \_\_\_\_\_ 122

## X

Xerox Phaser 3100 \_\_\_\_\_ 129

Xerox Phaser 3300 \_\_\_\_\_ 133

Xerox 106R441 / 106R442 \_\_\_\_\_ 126

Xerox 6R359 / 6R343 / 6R333  
6R881 / 6R737 \_\_\_\_\_ 125

Xerox 106R482 \_\_\_\_\_ 128

Xerox 6R899 \_\_\_\_\_ 124

Xerox 6R905 \_\_\_\_\_ 30

Xerox 6R907 \_\_\_\_\_ 50

Xerox 6R908 \_\_\_\_\_ 32

Xerox 6R914 \_\_\_\_\_ 127

Xerox 6R926 \_\_\_\_\_ 36

Xerox 6R927 \_\_\_\_\_ 33

Xerox 6R928 \_\_\_\_\_ 34

Xerox 6R929/6R0906 \_\_\_\_\_ 49

Xerox 6R932 \_\_\_\_\_ 37

Xerox 6R933 \_\_\_\_\_ 39

Xerox 113R296 \_\_\_\_\_ 84

Xerox 6R916 / 9R917 \_\_\_\_\_ 123

Xerox 013R00621 \_\_\_\_\_ 18



# Color Cartridges

(Cartridges are sorted by Printer Model)

## B

Brother HL4040CN, HL4070CDW / MFC9440CN, MFC9840CDW / MFC-9010CN MFC-9120CN / MFC-9320CW HL-3040CN / HL-3070CW	6
Brother HL4200 Series	22
Brother HL-2700CN MFC-9420CN(TN04)	85

## C

Canon RUNNER 3200	61
-------------------	----

## D

Dell 1320	24
Dell 1230	119
Dell 3100	20
Dell 3110 / 3130	25
Dell 5100	22

## E

Epson C1100 (CX11)	20
Epson C1000 / C2000 / C3000	98
Epson C900/ C1900	95

## H

HP 1500 / 2500 / 2550 / 2800 / 2840 /2820 2850	55
HP 1600/2600	57
HP 3500 / 4500 / 4600 / 5500	58
HP 3600 / 3800 / 4700	64
HP CP1215 / CP1518	71
HP CP2025 / 2020	75
HPCP4005	70
HP 8500	59
HP 8500 Drum Chip Replacement	60
HP 9500	61

## K

Konica Minolta QMS 2200/2400/2500	98
Konica Minolta QMS 2300/2350	95
Konica Minolta Magic Color 4650 / 4690 / 4695	76
Konica Minolta QMS 5430	93

## L

Lexmark C510/C710	85
Lexmark C910/C912/C920	86
Lexmark C522 / C524 / C530 / C532 / C534	87

## O

Okidata C3400	101
Okidata C5100 / C5150/C5200/ C5300/C5400 C7100/ C7200/C7300 / C7500/ B4100 / B4200 /B4300	100
Okidata C5500 / 5800 / C6100 / C8600 / C8800 / C9000	102



# Color Cartridges

(Cartridges are sorted by Printer Model)

## R

Ricoh SP C220	135
Ricoh CL3500	105
Ricoh CL4000 / SP C410 / C411	103
Ricoh CL7000 / CL7200	104
Ricoh CL1000N (Type 140)	85

## S

Samsung CLP 300	113
Samsung CLP 500	111
Samsung CLP 510	112
Samsung CLP 600	108
Samsung CLP 610 / 660	109
Samsung CLP 310 / 315	119

## X

Xerox 5500	134
Xerox 6100	111
Xerox 6110	113
Xerox 6130 / 6128	24
Xerox 6180	25
Xerox C525A	20
Xerox 6250, Xerox 6300 Series	22
Xerox 7300	130
Xerox 7400	131
Xerox 7750 / 7760	132

© All rights reserved, Easy Group, . Version 6.0

All trademarks are property of their respective owners. Uni-Kit® has no association with any of the manufacturers listed here such as Hp, Epson, Lexmark, Xerox, etc. All logos and brand names shown here are used for identification purposes only. It is illegal to reproduce these instructions without written licensing consent from Easy Group LLC.

Please be advised that some toner refill kits may be compatible with multiple toner cartridges.



Brother – TN250

[CLICK HERE TO GO THE INDEX](#)

#### REQUIRED FOR A SUCCESSFUL REFILL:

- Toner
- 1 funnel cap

#### *General Refilling Procedures:*

Using your thumb, lift up the black plastic tab so that it unlocks from the cartridge body. Rotate the entire black piece toward you. This will reveal a toner filling port.

Before opening the bottle of toner, turn it upside down and tap it on a table to loosen the toner and allow it to flow freely. Remove the cap and pull the seal off the bottle. Attach the funnel cap making to sure it is on tightly. Tilt the funnel cap toward the filling hole and insert it into the hole. If the toner stops flowing before the cartridge is full, simply remove the toner, close the cap, turn the bottle upside down and tap it on a table. Once the cartridge is full, twist the entire black plastic piece away from you until the tab locks back in place.





Please be advised that some toner refill kits may be compatible with multiple toner cartridges.



Brother – TN350

[CLICK HERE TO GO THE INDEX](#)

#### REQUIRED FOR A SUCCESSFUL REFILL:

- Toner
- 1 funnel cap

#### General Refilling Procedures:

Use a Flathead screwdriver to pop out the large plastic plug found on the side of the cartridge.

**IMPORTANT:** You must dispose of any original toner in the cartridge as much as possible before refilling. Dispose of toner properly into a trash can, or use a vacuum with a hose for best results (if possible).

Before opening the bottle of toner, turn it upside down and tap it on a table to loosen the toner and allow it to flow freely. Remove the cap and pull the seal off the bottle. Attach the funnel cap making sure it is on tightly. Tilt the funnel cap toward the filling hole and insert it into the hole. If the toner is flowing before the cartridge is full, simply remove the toner, close the cap, turn the bottle upside down and tap it on a table. Once the cartridge is full, seal the hole with the plug by twisting it until it is completely seated. Now gently shake the cartridge side to side to distribute the toner.



#### Installing Reset Gear on Starter Cartridges

Using the illustration below as a guide, remove the 3 screws indicated with red arrows. Once the screws have been removed, carefully and gently detach the side panel.



The picture on the right shows how the gear should be set once it has been placed within the panel. To insert the gear in this panel, slide the flag (which is the longest part of the gear) through the right side opening (green arrow on right side) and then slide the gear to the left. Once you have done this, hold the flag in place and place the panel back on the cartridge. Place the screws back in place and your cartridge is ready to be used.

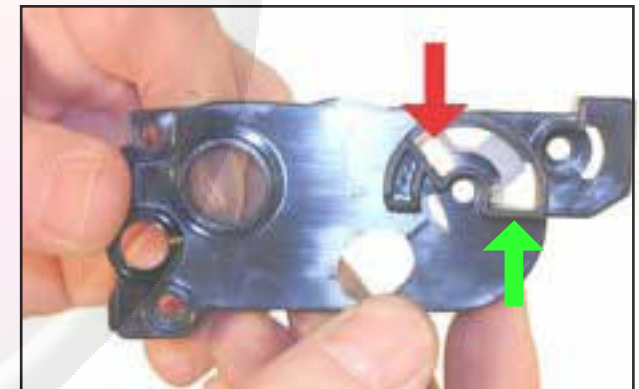

Please be advised that some toner refill kits may be compatible with multiple toner cartridges.



Brother – TN330 / TN360

[CLICK HERE TO GO THE INDEX](#)

#### REQUIRED FOR A SUCCESSFUL REFILL:

- Toner
- 1 funnel

#### General Refilling Procedures:

Use a Flathead screwdriver to pop out the large plastic plug found on the side of the side of the cartridge.

**IMPORTANT:** You must dispose of any original toner in the cartridge as much as possible before refilling. Dispose of toner properly into a trash can, or use a vacuum with a hose for best results (if possible).

Before opening the bottle of toner, turn it upside down and tap it on a table to loosen the toner and allow it to flow freely. Remove the cap and pull the seal off the bottle. Attach the funnel cap making sure it is on tightly. Tilt the funnel cap toward the filling hole and insert it into the hole. If the toner stops flowing before the cartridge is full, simply remove the toner, close the cap, turn the bottle upside down and tap it on a table. Once the cartridge is full, seal the hole with the plug by twisting it until it is completely seated. Now gently shake the cartridge side to side to distribute the toner.



#### Installing Reset Gear on Starter Cartridges

1. Remove the screws circled in red in the illustration above. Carefully detach the panel from the cartridge.
2. Reset the flag gear by turning it into the correct position. The picture on the right shows the flag gear in the correct position.
3. Screw the panel back into place, and your cartridge is ready.

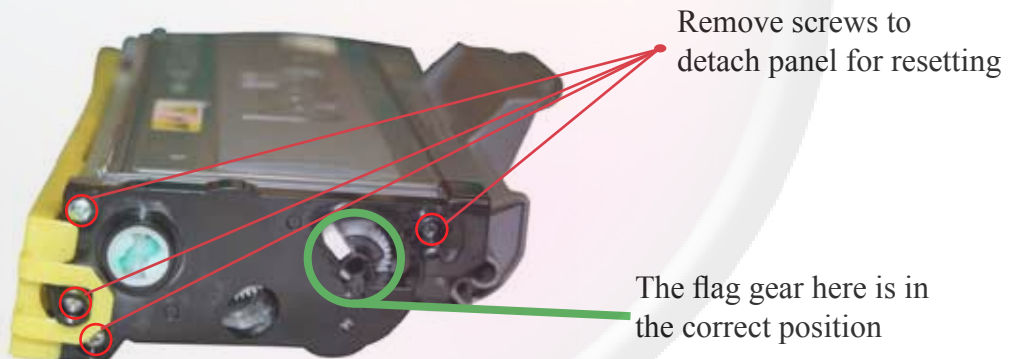

Please be advised that some toner refill kits may be compatible with multiple toner cartridges.



Brother – TN430/460/560

[CLICK HERE TO GO THE INDEX](#)

#### REQUIRED FOR A SUCCESSFUL REFILL:

- Toner
- 1 funnel cap
- 1 hole plug
- Toner Hole Making Tool

#### *General Refilling Procedures:*

**CRITICAL NOTE:** You must remove all of the remaining old toner BEFORE refilling otherwise you will get gray hazy prints.

Use a Flathead screwdriver to pop out the large plastic plug found on the side of the side of the cartridge.

Before opening the bottle of toner, turn it upside down and tap it on a table to loosen the toner and allow it to flow freely. Remove the cap and pull the seal off the bottle. Attach the funnel cap making to sure it is on tightly. Tilt the funnel cap toward the filling hole and insert it into the hole. If the toner stops flowing before the cartridge is full, simply remove the toner, close the cap, turn the bottle upside down and tap it on a table. Once the cartridge is full, seal the hole with the plug by twisting it until it is completely seated. Now gently shake the cartridge side to side to distribute the toner.





Please be advised that some toner refill kits may be compatible with multiple toner cartridges.



Brother – TN540 / 550 / 570 / 580 / 650

[CLICK HERE TO GO THE INDEX](#)

#### REQUIRED FOR A SUCCESSFUL REFILL:

- Toner
- 1 funnel cap

#### General Refilling Procedures:

Use a Flathead screwdriver to pop out the large plastic plug found on the side of the side of the cartridge.

**IMPORTANT:** You must dispose of any original toner in the cartridge as much as possible before refilling. Dispose of toner properly into a trash can, or use a vacuum with a hose for best results (if possible).

Before opening the bottle of toner, turn it upside down and tap it on a table to loosen the toner and allow it to flow freely. Remove the cap and pull the seal off the bottle. Attach the funnel cap making to sure it is on tightly. Tilt the funnel cap toward the filling hole and insert it into the hole. If the toner stops flowing before the cartridge is full, simply remove the toner, close the cap, turn the bottle upside down and tap it on a table. Once the cartridge is full, seal the hole with the plug by twisting it until it is completely seated. Now gently shake the cartridge side to side to distribute the toner.



#### Installing Reset Gear on Starter Cartridges



1. Remove the screws circled in red in the illustration above. Carefully detach the panel from the cartridge.

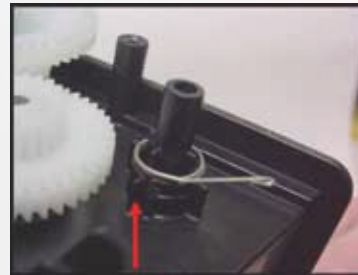

2. Set the flag gear spring on the gear post as shown above. Set the small end of the spring on the slot on the gear post.



2. Place the flag gear on the post and position the spring as shown above.

© All rights reserved, Easy Group, LLC. Version 6.0

All trademarks are property of their respective owners. Uni-Kit® has no association with any of the manufacturers listed here such as Hp, Epson, Lexmark, Xerox, etc. All logos and brand names shown here are used for identification purposes only. It is illegal to reproduce these instructions without written licensing consent from Easy Group LLC.

Please be advised that some toner refill kits may be compatible with multiple toner cartridges.



Brother – TN110/TN115 / TN210/TN215

[CLICK HERE TO GO THE INDEX](#)

#### REQUIRED FOR A SUCCESSFUL REFILL:

- Toner
- 1 funnel cap
- Flathead screw driver (Not Included)

#### General Refilling Procedures:

Use a Flathead screwdriver to pop out the large plastic plug found on the side of the side of the cartridge.

**IMPORTANT:** You must dispose of any original toner in the cartridge as much as possible before refilling. Dispose of toner properly into a trash can, or use a vacuum with a hose for best results (if possible). For the TN-110, please be sure you only use half the toner in the bottle. Do not overfill the cartridge by pouring the entire toner powder into the cartridge. Overfilling can and will damage a cartridge.

Before opening the bottle of toner, turn it upside down and tap it on a table to loosen the toner and allow it to flow freely. Remove the cap and pull the seal off the bottle. Attach the funnel cap making to sure it is on tightly. Tilt the funnel cap toward the filling hole and insert it into the hole. If the toner stops flowing before the cartridge is full, simply remove the toner, close the cap, turn the bottle upside down and tap it on a table. Once the cartridge is full, seal the hole with the plug by twisting it until it is completely seated. Now gently shake the cartridge side to side to distribute the toner.

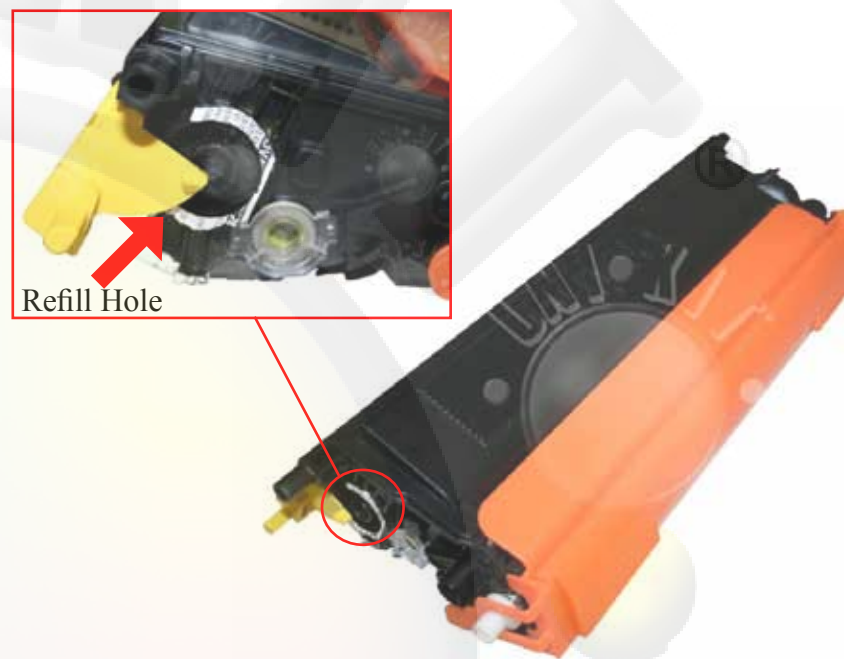

#### Resetting the counter (Reset Gear)

Using the illustration below as a guide, remove the 2 screws indicated with red circles. Once the screws have been removed, carefully and gently (with a Flathead screwdriver) unlock the side panel and remove the side cap.

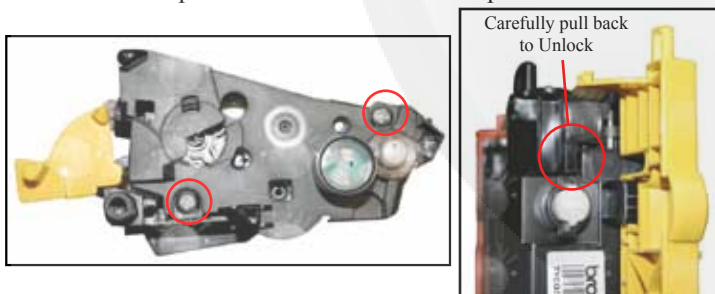

After removing the side panel (as instructed on the left); The 2 pictures on the right show how the gear should be set in order to reset the counter. Carefully remove the gear and the pin holding it in place. Turn the gear clock wise and replace it so that it meshes and matches the “Properly Resetted” picture to the right. Re-install the pin so that it holds the gear down. Once the gear is resetted, re-install the side cap, and place the screws firmly back in place. Your cartridge is ready to be used.



Not Resetted

Properly Resetted





Please be advised that some toner refill kits may be compatible with multiple toner cartridges.



Canon - E16/E20/E31/E40

[CLICK HERE TO GO THE INDEX](#)

#### REQUIRED FOR A SUCCESSFUL REFILL:

- Toner
- 1 funnel cap
- 1 hole plug
- Toner Hole Making Tool *(Not Included, Sold Separately)*

#### General Refilling Procedures:

Rest the Hole Making Tool on its stand and plug into an outlet. Wait 3 full minutes before using. Position the copper bit on the cartridge in the spot indicated by the photograph and push gently until it melts a hole in the cartridge. Remove the tool, place it back on its stand and unplug it. If the small piece of plastic has fallen into the cartridge, it must be removed, as this can damage your cartridge or cause print defects. If the piece remains in the tool, wait for the tool to cool down and pry it out.

Before opening the bottle of toner, turn it upside down and tap it on a table to loosen the toner and allow it to flow freely. Remove the cap and pull the seal off the bottle. Attach the funnel cap making to sure it is on tightly. Tilt the funnel cap toward the filling hole and insert it into the hole. If the toner stops flowing before the cartridge is full, simply remove the toner, close the cap, turn the bottle upside down and tap it on a table. Once the cartridge is full seal the hole with the plug.

Do not press down on the plug since the cartridge is resting on a table this can actually damage the photo-optic drum. Instead hold one end of the cartridge up off the table and twist the plug until it fully sealed. Now gently shake the cartridge side to side to distribute the toner.



Please be advised that some toner refill kits may be compatible with multiple toner cartridges.



Canon - L50

[CLICK HERE TO GO THE INDEX](#)

#### REQUIRED FOR A SUCCESSFUL REFILL:

- Toner
- 1 funnel cap
- 1 hole plug (electrical or duct tape will do as well)
- Toner Hole Making Tool

#### General Refilling Procedures:

Rest the Hole Making Tool on its stand and plug into an outlet. Wait 3 full minutes before using. Position the copper bit on the cartridge in the spot indicated by the photograph and push gently until it melts a hole in the cartridge. Remove the tool, place it back on its stand and unplug it. If the small piece of plastic has fallen into the cartridge, it must be removed, as this can damage your cartridge or cause print defects. If the piece remains in the tool, wait for the tool to cool down and pry it out.

***IMPORTANT: You must dispose of any original toner in the cartridge as much as possible before refilling. Dispose of toner properly into a trash can, or use a vacuum with a hose for best results (if possible).***

Before opening the bottle of toner, turn it upside down and tap it on a table to loosen the toner and allow it to flow freely. Remove the cap and pull the seal off the bottle. Attach the funnel cap making to sure it is on tightly. Tilt the funnel cap toward the filling hole and insert it into the hole. If the toner stops flowing before the cartridge is full, simply remove the toner, close the cap, turn the bottle upside down and tap it on a table. Once the cartridge is full seal the hole with the plug or electrical tape (Duct tape will do as well).

*Note: If there are gears that rotate near the refill hold created, do not use the plug, instead use electrical tape or duct tape to seal the hole.*

Gently rock the cartridge from side to side for about 5-10 seconds to distribute the toner in the hopper. Your cartridge is now ready for use.



With the hole making tool, make a refill hole here

Please be advised that some toner refill kits may be compatible with multiple toner cartridges.



[CLICK HERE TO GO THE INDEX](#)

Canon – S35  
Canon – X25

#### REQUIRED FOR A SUCCESSFUL REFILL:

- Toner
- 1 funnel cap
- 1 hole plug
- Toner Hole Making Tool *(Not Included, Sold Separately)*

#### General Refilling Procedures:

Rest the Hole Making Tool on its stand and plug into an outlet. Wait 3 full minutes before using. Position the copper bit on the cartridge in the spot indicated by the photograph and push gently until it melts a hole in the cartridge. Make sure to keep the hole on the flat surface of the cartridge and not on the curved edge. Remove the tool, place it back on its stand and unplug it. If the small piece of plastic has fallen into the cartridge, it must be removed, as this can damage your cartridge or cause print defects. If the piece remains in the tool, wait for the tool to cool down and pry it out.

Before opening the bottle of toner, turn it upside down and tap it on a table to loosen the toner and allow it to flow freely. Remove the cap and pull the seal off the bottle. Attach the funnel cap making to sure it is on tightly. Tilt the funnel cap toward the filling hole and insert it into the hole. If the toner stops flowing before the cartridge is full, simply remove the toner, close the cap, turn the bottle upside down and tap it on a table. Once the cartridge is full seal the hole with the plug.

Do not press down on the plug since the cartridge is resting on a table this can actually damage the photo-optic drum. Instead hold one end of the cartridge up off the table and twist the plug until it fully sealed. Now gently shake the cartridge side to side to distribute the toner.

**NOTE:** If after the cartridge is refilled and it starts to print gray smudges or smears along the margin, the waste hopper could be full. Please refer to the supplemental instructions (page 2) for emptying the waste hopper.



Waste Hopper Instructions for Canon S35 / X25:  
(Do this procedure over a newspaper)

Turn the cartridge right side up. Using the hole making tool, position the copper bit on the cartridge in the spot indicated by the photograph and push gently until it melts a hole in the cartridge. Once the hole has been made, turn the cartridge over so that the hole is facing the newspaper. Gently rock the cartridge back and forth allowing the toner to fall onto the newspaper. Do this repeatedly to remove as much waste toner as possible. Don't worry about getting all of the toner out. Now clean around hole with a soft dry cloth. Use duct tape to seal the hole.

Please be advised that some toner refill kits may be compatible with multiple toner cartridges.



Canon – F100

[CLICK HERE TO GO THE INDEX](#)

#### REQUIRED FOR A SUCCESSFUL REFILL:

- Toner
- 1 funnel cap
- 1 hole plug
- Toner Hole Making Tool

#### *General Refilling Procedures:*

Rest the Hole Making Tool on its stand and plug into an outlet. Wait 3 full minutes before using. Position the tan portion of the cartridge on your right. Position the copper bit on the cartridge in the spot indicated by the photograph and push gently until it melts a hole in the cartridge. Remove the tool, place it back on its stand and unplug it. If the small piece of plastic has fallen into the cartridge, it must be removed, as this can damage your cartridge or cause print defects. If the piece remains in the tool, wait for the tool to cool down and pry it out.

Before opening the bottle of toner, turn it upside down and tap it on a table to loosen the toner and allow it to flow freely. Remove the cap and pull the seal off the bottle. Attach the funnel cap making sure it is on tightly. Tilt the funnel cap toward the filling hole and insert it into the hole. If the toner stops flowing before the cartridge is full, simply remove the toner, close the cap, turn the bottle upside down and tap it on a table. Once the cartridge is full seal the hole with the plug.

Do not press down on the plug since the cartridge is resting on a table this can actually damage the photo-optic drum. Instead hold one end of the cartridge up off the table and twist the plug until it fully sealed. Now gently shake the cartridge side to side to distribute the toner.

**make  
hole**

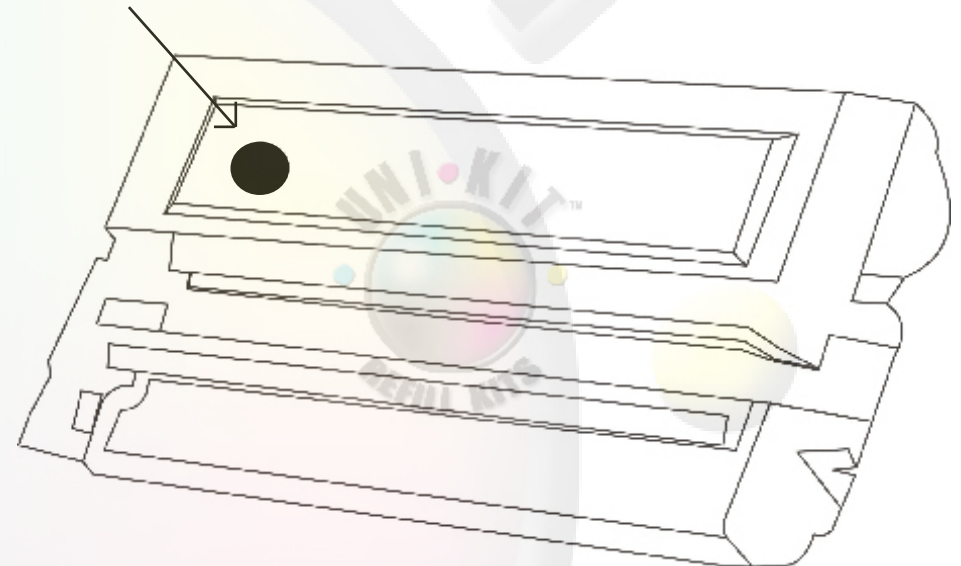



Please be advised that some toner refill kits may be compatible with multiple toner cartridges.



CANON A30, A15

[CLICK HERE TO GO THE INDEX](#)

#### REQUIRED FOR A SUCCESSFUL REFILL:

- Toner
- 1 funnel cap
- 1 hole plug (electrical or duct tape will do as well)
- Toner Hole Making Tool

#### *General Refilling Procedures:*

Rest the Hole Making Tool on its stand and plug into an outlet. Wait 3 full minutes before using. Position the copper bit on the cartridge in the spot indicated by the photograph and push gently until it melts a hole in the cartridge. Remove the tool, place it back on its stand and unplug it. If the small piece of plastic has fallen into the cartridge, it must be removed, as this can damage your cartridge or cause print defects. If the piece remains in the tool, wait for the tool to cool down and pry it out.

Before opening the bottle of toner, turn it upside down and tap it on a table to loosen the toner and allow it to flow freely. Remove the cap and pull the seal off the bottle. Attach the funnel cap making to sure it is on tightly. Tilt the funnel cap toward the filling hole and insert it into the hole. If the toner stops flowing before the cartridge is full, simply remove the toner, close the cap, turn the bottle upside down and tap it on a table. Once the cartridge is full seal the hole with the plug.

Do not press down on the plug since the cartridge is resting on a table this can actually damage the photo-optic drum. Instead hold one end of the cartridge up off the table and twist the plug until it fully sealed. Now gently shake the cartridge side to side to distribute the toner.





Please be advised that some toner refill kits may be compatible with multiple toner cartridges.



CANON FX-8  
CANON S-35

[CLICK HERE TO GO THE INDEX](#)

#### REQUIRED FOR A SUCCESSFUL REFILL:

- Toner
- 1 funnel cap
- 1 hole plug
- Toner Hole Making Tool

#### *General Refilling Procedures:*

Rest the Hole Making Tool on its stand and plug into an outlet. Wait 3 full minutes before using. Position the copper bit on the cartridge in the spot indicated in the photograph and push gently until it melts a hole in the cartridge. Make sure to keep the hole on the flat surface of the cartridge and not on the curved edge. Remove the tool, place it back on its stand and unplug it. If the small piece of plastic has fallen into the cartridge, it must be removed, as this can damage your cartridge or cause print defects. If the piece remains in the tool, wait for the tool to cool down and pry it out.

Create a hole on the opposite end where the waste toner is located. Empty the waste toner as much as possible, then seal it with electrical tape or duct tape. Once you have sealed it proceed to the next step.

Before opening the bottle of toner, turn it upside down and tap it on a table to loosen the toner and allow it to flow freely. Remove the cap and pull the seal off the bottle. Attach the funnel cap making to sure it is on tightly. Tilt the funnel cap toward the filling hole and insert it into the hole. If the toner stops flowing before the cartridge is full, simply remove the toner, close the cap, turn the bottle upside down and tap it on a table. Once the cartridge is full seal the hole with the plug.

Do not press down on the plug since the cartridge is resting on a table this can actually damage the photo-optic drum. Instead hold one end of the cartridge up off the table and twist the plug until it fully sealed. Now gently shake the cartridge side to side to distribute the toner.



Please be advised that some toner refill kits may be compatible with multiple toner cartridges.



CANON FX-9/FX-10/104

[CLICK HERE TO GO THE INDEX](#)

#### REQUIRED FOR A SUCCESSFUL REFILL:

- Toner
- 1 funnel cap
- 1 hole (Optional - Electrical Tape/Duct Tape)
- Toner Hole Making Tool

#### General Refilling Procedures:

Rest the Hole Making Tool on its stand and plug into an outlet. Wait 3 full minutes before using. Position the copper bit on the cartridge in the spot indicated in photograph A and push gently until it melts a hole in the cartridge. Make sure to keep the hole on the flat surface of the cartridge and not on the curved edge. Remove the tool, place it back on its stand and unplug it. If the small piece of plastic has fallen into the cartridge, it must be removed, as this can damage your cartridge or cause print defects. If the piece remains in the tool, wait for the tool to cool down and pry it out.

***IMPORTANT: You must dispose of any original toner in the cartridge as much as possible before refilling. Dispose of toner properly into a trash can, or use a vacuum with a hose for best results (if possible). Do not overfill the cartridge by pouring the entire toner powder into the cartridge. Use half the bottle now, and the rest at a later time. Overfilling can and will damage a cartridge.***

Before opening the bottle of toner, turn it upside down and tap it on a table to loosen the toner and allow it to flow freely. Remove the cap and pull the seal off the bottle. Attach the funnel cap making to sure it is on tightly. Tilt the funnel cap toward the filling hole and insert it into the hole. If the toner stops flowing before the cartridge is full, simply remove the toner, close the cap, turn the bottle upside down and tap it on a table. Once the cartridge is full seal the hole with the plug.

Do not press down on the plug since the cartridge is resting on a table this can actually damage the photo-optic drum. Instead hold one end of the cartridge up off the table and twist the plug until it fully sealed. Now gently shake the cartridge side to side to distribute the toner.

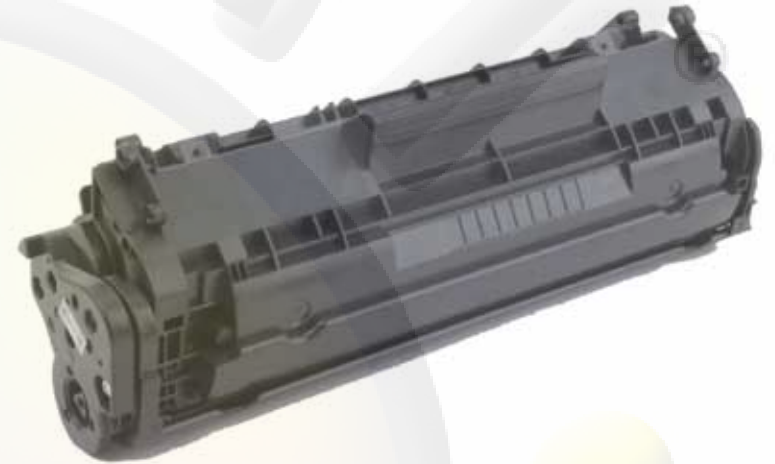

Please be advised that some toner refill kits may be compatible with multiple toner cartridges.



## CANON CARTRIDGE 106

[CLICK HERE TO GO THE INDEX](#)

### REQUIRED FOR A SUCCESSFUL REFILL:

- Toner
- 1 funnel cap
- 1 hole (Optional Electrical Tape/Duct Tape)
- Toner Hole Making Tool

### General Refilling Procedures:

Rest the Hole Making Tool on its stand and plug into an outlet. Wait 3 full minutes before using. Position the copper bit on the cartridge in the spot indicated in photograph A and push gently until it melts a hole in the cartridge. Make sure to keep the hole on the flat surface of the cartridge and not on the curved edge. Remove the tool, place it back on its stand and unplug it. If the small piece of plastic has fallen into the cartridge, it must be removed, as this can damage your cartridge or cause print defects. If the piece remains in the tool, wait for the tool to cool down and pry it out.

**IMPORTANT:** You must dispose of any original toner in the cartridge as much as possible before refilling. Dispose of toner properly into a trash can. Do not overfill the cartridge by pouring the entire toner powder into the cartridge. Use half or a fourth of the bottle now, and the rest at a later time. Overfilling can and will damage a cartridge.

Before opening the bottle of toner, turn it upside down and tap it on a table to loosen the toner and allow it to flow freely. Remove the cap and pull the seal off the bottle. Attach the funnel cap making sure it is on tightly. Tilt the funnel cap toward the filling hole and insert it into the hole. If the toner stops flowing before the cartridge is full, simply remove the toner, close the cap, turn the bottle upside down and tap it on a table. Once the cartridge is full seal the hole properly.

Now gently shake the cartridge side to side to distribute the toner.



Create Refill Hole Here





Please be advised that some toner refill kits may be compatible with multiple toner cartridges.



#### REQUIRED FOR A SUCCESSFUL REFILL:

- Toner
- 1 funnel cap
- 1 hole plug (Optional Electrical Tape/Duct Tape)
- Toner Hole Making Tool

#### General Refilling Procedures:

Rest the Hole Making Tool on its stand and plug into an outlet. Wait 3 full minutes before using. Position the copper bit on the cartridge in the spot indicated in photograph A and push gently until it melts a hole in the cartridge. Make sure to keep the hole on the flat surface of the cartridge and not on the curved edge. Remove the tool, place it back on its stand and unplug it. If the small piece of plastic has fallen into the cartridge, it must be removed, as this can damage your cartridge or cause print defects. If the piece remains in the tool, wait for the tool to cool down and pry it out.

**IMPORTANT:** You must dispose of any original toner in the cartridge as much as possible before refilling. Dispose of toner properly into a trash can, or use a vacuum with a hose for best results (if possible). Do not overfill the cartridge by pouring the entire toner powder into the cartridge. Use half the bottle now, and the rest at a later time. Overfilling can and will damage a cartridge.

Before opening the bottle of toner, turn it upside down and tap it on a table to loosen the toner and allow it to flow freely. Remove the cap and pull the seal off the bottle. Attach the funnel cap making sure it is on tightly. Tilt the funnel cap toward the filling hole and insert it into the hole. If the toner stops flowing before the cartridge is full, simply remove the toner, close the cap, turn the bottle upside down and tap it on a table. Once the cartridge is full seal the hole with the plug.

Do not press down on the plug since the cartridge is resting on a table this can actually damage the photo-optic drum. Instead hold one end of the cartridge up off the table and twist the plug until it fully sealed. Now gently shake the cartridge side to side to distribute the toner. Replace the chip, and you are not ready to use the cartridge.

Dell S-35  
Lexmark 08A0477  
Lexmark 08A0478

[CLICK HERE TO GO THE INDEX](#)



Please be advised that some toner refill kits may be compatible with multiple toner cartridges.



Lexmark E220 / E321 / E323    Dell P1500    IBM InfoPrint 1312

[CLICK HERE TO GO THE INDEX](#)



### General Refilling Procedures:

Rest the Hole Making Tool on its stand and plug into an outlet. Wait 3 full minutes before using. Position the copper bit on the cartridge in the spot indicated by the photograph and push gently until it melts a hole in the cartridge. Remove the tool, place it back on its stand and unplug it. If the small piece of plastic has fallen into the cartridge, it must be removed, as this can damage your cartridge or cause print defects. If the piece remains in the tool, wait for the tool to cool down and pry it out.

Before opening the bottle of toner, turn it upside down and tap it on a table to loosen the toner and allow it to flow freely. Remove the cap and pull the seal off the bottle. Attach the funnel cap making sure it is on tightly. Tilt the funnel cap toward the filling hole and insert it into the hole. If the toner stops flowing before the cartridge is full, simply remove the toner, close the cap, turn the bottle upside down and tap it on a table. Once the cartridge is full seal the hole with the plug.

Do not press down on the plug since the cartridge is resting on a table this can actually damage the photo-optic drum. Instead hold one end of the cartridge up off the table and twist the plug until it fully sealed. Now gently shake the cartridge side to side to distribute the toner. Important: These cartridges have a chip that needs to be replaced in order for the printer to recognize the refilled cartridge. This chip is located on the side of the cartridge as shown in the picture. To access the chip, you need to unscrew three (3) screws on the end-cap of the cartridge around the chip. **BE VERY CAREFUL** when removing the end cap because there is a spring that could fall loose. You need to remove this spring in order for the cap to come off completely. Make sure you notice where the spring is do you can put it back the same way. Also **BE VERY CAREFUL** when removing the cap so that the gears on the inside of the end cap do not fall out, if they do you need to place them back. Once the cap has been removed, you will be able to remove the old chip. You have to now install a new compatible chip, making sure the contacts are positioned as in the diagram here. Carefully replace the end cap after you have installed the new chip.



Please be advised that some toner refill kits may be compatible with multiple toner cartridges.



DELL P1600

[CLICK HERE TO GO THE INDEX](#)

**BEFORE YOU REFILL THIS CARTRIDGE**, it is necessary to open the cartridge and replace the smartchip. Be sure to do this at a workbench, outside, or anywhere where you can tolerate a spill. If you are careful there will be no spill.

- 1) Allow the cartridge to rest on a flat surface with the top of the cartridge facing up, like the picture below.
- 2) Using a screwdriver, remove the 5 screws that are located on the TOP of the cartridge as shown
- 3) Slowly remove the top cover of the cartridge
- 4) You have now separated the cartridge into 2 parts (the cover, and the underlying part)
- 5) Locate the smartchip as shown in the image below, and replace it with a new replacement chip
- 6) Now replace the cover of the cartridge and replace all 5 screws, making sure the cover is securely attached



- 1) Top of the cartridge facing up
- 2) Remove the 5 screws



3) Remove the toner cap

4) By so doing, you separate the cartridge into 2 parts. The smartchip is in the bottom part, identified by the arrow



5) Replace the smartchip with a new chip

### **NOW YOU CAN REFILL THE CARTRIDGE USING THE BOTTLE OF TONER**

1) Identify the filling hole on the side of the cartridge as shown in the picture. There may be a sticker over the filling cap that says "DO NOT REMOVE". It is OK to remove this sticker. The plastic sealing cap can be easily removed by prying it out with a flat screwdriver, but be careful not to damage this plastic cap as you need to place it back after you refill

2) Now you can fill the cartridge with toner. Before opening the bottle of toner, turn it upside down and tap it on a table to loosen the toner and allow it to flow freely. Remove the cap and pull the seal off the bottle. Attach the funnel cap making to sure it is on tightly. Tilt the funnel cap toward the filling hole and insert it into the hole. If the toner stops flowing before the cartridge is full, simply remove the toner, close the cap, turn the bottle upside down and tap it on a table. Once the cartridge is full seal the hole with the original plug.



© All rights reserved, Easy Group, LLC. Version 6.0

All trademarks are property of their respective owners. Uni-Kit® has no association with any of the manufacturers listed here such as Hp, Epson, Lexmark, Xerox, etc. All logos and brand names shown here are used for identification purposes only. It is illegal to reproduce these instructions without written licensing consent from Easy Group LLC.

Please be advised that some toner refill kits may be compatible with multiple toner cartridges.



Dell 1100 / Samsung ML-2010 / ML-1610 / Samsung SCX-4321 /  
Samsung ML-2510 / SCX-4521 / SCX-4725 / Xerox PE220

[CLICK HERE TO GO THE INDEX](#)

#### REQUIRED FOR A SUCCESSFUL REFILL:

- Toner
- 1 Phillips screwdriver and flat head screw driver
- Needle nose pliers

Note: Please read carefully before refilling cartridge.

#### General Refilling Procedures:

Using the screw driver, remove the screws on the side of the cartridge so that the sealing plug can be revealed (Illustration A.). Once you have located the sealing plug, use the flat head screw driver to gently loosen the sealing plug (Illustration B.). With the needle nose pliers, gently, but forcefully pull the plug completely off the cartridge. If the plug happens to bent or crack, you may use electrical tape or duct tape to securely seal the cracks or bents once you have replaced the plug at the end of the refill process.

Empty any toner left inside the cartridge (mixing two different brands of toners could result in bad printing, or rare discoloration in your prints).

Before opening the bottle of toner, turn it upside down and tap it on a table to loosen the toner and allow it to flow freely. Remove the cap and pull the seal off the bottle. Attach the funnel cap making to sure it is on tightly. Tilt the cartridge at a 45 degree angle and then the funnel cap toward the filling hole and insert it into the hole. If the toner stops flowing before the cartridge is full, simply remove the toner, close the cap, turn the bottle upside down and tap it on a table. Once you are done refilling this cartridge, place the sealing plug back in its place and use duct tape or electrical tape to seal up any necessary cracks on the plug.

Replace the fuse for this cartridge (Illustration B shows the fuse compartment). Once you have replaced the fuse, you may now reinsert your cartridge back into your printer and begin printing. Changing the fuse is only required for the Dell 1100 and Samsung 2010 cartridge.

A.



B.



NOTE: Some starter cartridges do not have a fuse installed in this compartment, however, one must be installed to reset the cartridge.

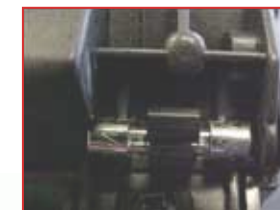

### Samsung SCX 4725

To remove the chip, simply use a flathead screw driver to gently pry it from the side panel, before placing it back after the refill. Place the new chip into the panel, close it, then place the side cap back onto the cartridge.





Please be advised that some toner refill kits may be compatible with multiple toner cartridges.

DELL 1700  
LEXMARK E120/E230/E232/E238/E330/E332/E340  
IBM 4312

[CLICK HERE TO GO THE INDEX](#)

**Note:** For Lexmark E120, there is a chip that needs to be replaced in order for the cartridge to function in the printer. Peel and stick the chip in place of the original chip

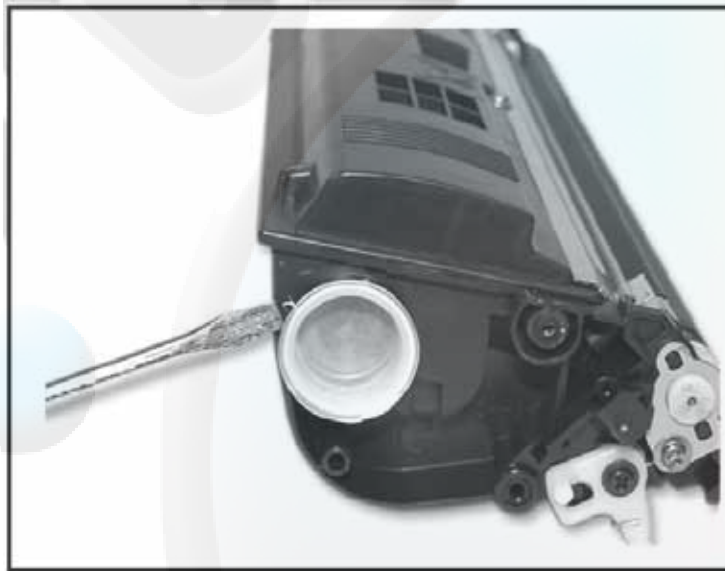

**Note:** Always refill in a well ventilated environment, preferably outside or at a workbench  
1. Using a flat screwdriver, carefully remove the fill cap located under the sticker in the diagram below. Attach the pouring nozzle to the toner bottle, and pour toner into the cartridge. After refilling, replace the fill plug.





Please be advised that some toner refill kits may be compatible with multiple toner cartridges.

DELL 3100 / Epson C1100 (CX11) / XEROX C525A

[CLICK HERE TO GO THE INDEX](#)

Note: Always refill in a well ventilated environment, preferably outside or at a workbench



1. Use a small flat-head screwdriver to lift the tap over the stopper and allow you to turn the blue end piece counterclockwise (color of end piece varies on color of cartridge).



2. This is the starting point.



3. Turn the cap until the tab comes to a complete stop and has entered under the blue cap.



4. Now pull the cap, out away from the cartridge..



5. Remove the carrier fill plug.



6. This is the waste carrier chamber, empty it out and you will find the toner fill plug. Remove it to clean cartridge and fill toner..

**NOTE: Mix toner and carrier in the same toner bottle before refilling the toner hopper.**

#### TROUBLESHOOTING:

If the Dell 3100 printer does not recognize the refilled cartridge, follow these steps:

- 1) Restart the printer by turning it off for 2-3 minutes, then turning it back on
- 2) After the printer has restarted, take out the cartridge and shake it and reinstall it
- 3) If these steps don't work, try removing waste toner from the waste hopper. The reason for this is because if the machine sees too much toner in the waste hopper, it may think the cartridge is empty.

Please be advised that some toner refill kits may be compatible with multiple toner cartridges.



DELL 3100 / Epson C1100 (CX11) / XEROX C525A

[CLICK HERE TO GO THE INDEX](#)

### Chip Replacement

1.



2.



3.







Please be advised that some toner refill kits may be compatible with multiple toner cartridges.

DELL 5100cn Series / BROTHER TN-12  
XEROX 6250, XEROX 6300 Series

[CLICK HERE TO GO THE INDEX](#)



#### REMOVING THE GEARLESS END CAP

1. Remove the gearless end cap (shown) to access the toner fill cap. Using a small flathead screwdriver, carefully push out one side of the end cap (shown) to unlock it from the first set of tabs.



2. Rotate the cartridge and disengage the third tab (shown) in the same manner.



3. Disengage the fourth tab as shown.



4. Carefully slide out the gearless end cap.



5. Carefully insert a small flathead screwdriver between the base of the toner fill plug and its housing as shown.



6. Carefully lift the toner fill plug out as shown. Be careful not to damage the plastic housing.

*Instructions continued on next page...*



Please be advised that some toner refill kits may be compatible with multiple toner cartridges.

DELL 5100cn Series  
BROTHER TN-12  
XEROX 6250, XEROX 6300 Series

[CLICK HERE TO GO THE INDEX](#)



7. Fill cartridge with toner and reassemble the cartridge.



8. Using a small flathead screwdriver, press down on the tabs (shown on either side) to release the chip housing.



9. Always wear latex gloves when handling chips.



10. Unlock the actual chip from its housing by pressing the tabs (shown) using an angled hook tool.



11. Carefully lift the chip from its housing.



12. Place the new chip on the cartridge in the manner shown.



13. Place the housing over the chip as shown.



14. Press down until the tabs lock it into place.

Please be advised that some toner refill kits may be compatible with multiple toner cartridges.



DELL 1320/ -- Xerox 6130 / 6128

[CLICK HERE TO GO THE INDEX](#)

### REQUIRED FOR A SUCCESSFUL REFILL:

- Toner
- 1 funnel cap
- 1 Flathead Screwdriver

### General Refilling Procedures:

Pull the cap out by pushing the tab over the stopper using a flat head screw driver (shown in Illustration A and B). Do this very carefully, the toner inside the cartridge will spill, so open this over a work bench. Next remove the cap that divides the toner hopper from the waste toner hopper (Illustration C).

**IMPORTANT:** You must dispose of any original toner in the cartridge as much as possible before refilling (Illustration D). Dispose of toner properly into a trash can, or use a vacuum with a hose for best results (if possible).

Before opening the bottle of toner, turn it upside down and tap it on a table to loosen the toner and allow it to flow freely. Remove the cap and pull the seal off the bottle. Attach the funnel cap making sure it is on tightly. Tilt the funnel cap toward the toner hopper and begin to pour toner into the hopper. If the toner stops flowing before the cartridge is full, simply remove the toner, close the cap, turn the bottle upside down and tap it on a table. Once the cartridge is full work backwards at replacing the caps back on.

Once the cartridge is reassembled, gently shake the cartridge side to side to distribute the toner. Replace the chip by following illustration E and F. Once the chip is replaced, your cartridge is ready for use.

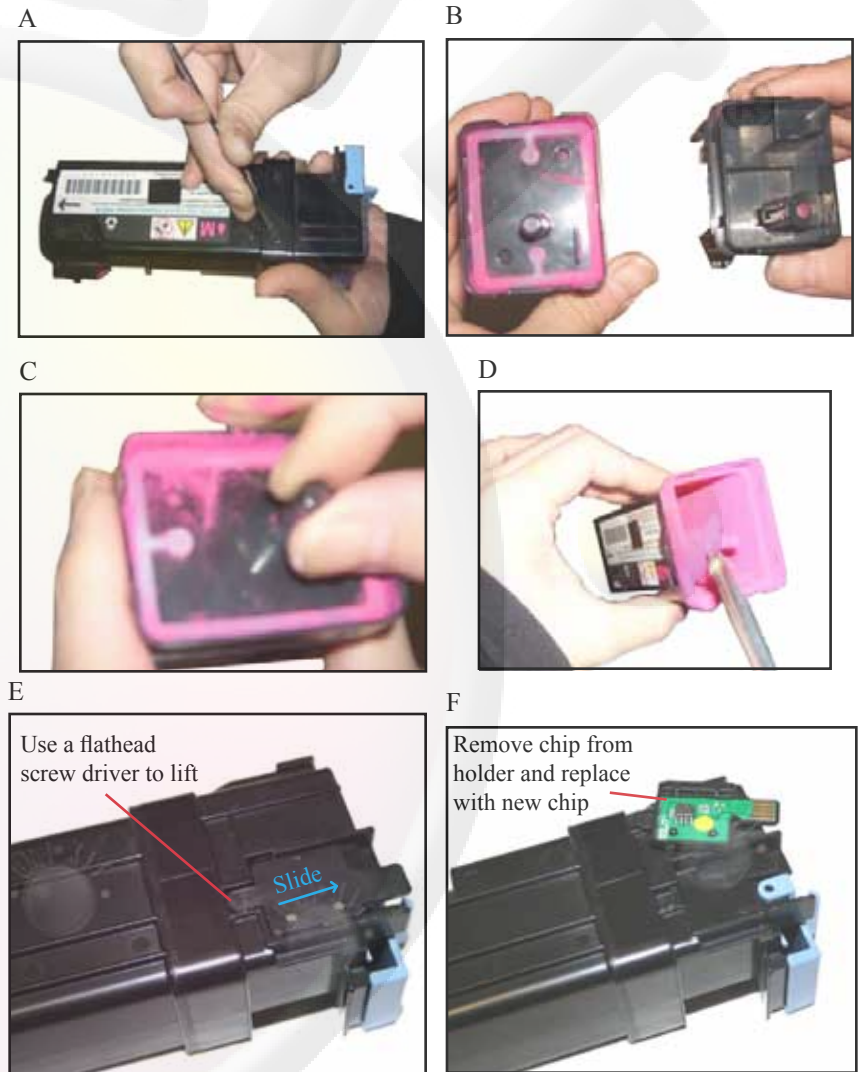



Please be advised that some toner refill kits may be compatible with multiple toner cartridges.



DELL 3110CN / 3130 - XEROX 6180

[CLICK HERE TO GO THE INDEX](#)

#### REQUIRED FOR A SUCCESSFUL REFILL:

- Toner
- 1 funnel cap
- 1 hole plug (Optional - Electrical Tape/Duct Tape)
- Toner Hole Making Tool

#### General Refilling Procedures:

Rest the Hole Making Tool on its stand and plug into an outlet. Wait 3 full minutes before using. Position the copper bit on the cartridge in the spot indicated in photograph A and push gently until it melts a hole in the cartridge. Make sure to keep the hole on the flat surface of the cartridge and not on the curved edge. Remove the tool, place it back on its stand and unplug it. If the small piece of plastic has fallen into the cartridge, it must be removed, as this can damage your cartridge or cause print defects. If the piece remains in the tool, wait for the tool to cool down and pry it out.

**IMPORTANT:** You must dispose of any original toner in the cartridge as much as possible before refilling. Dispose of toner properly into a trash can. Do not overfill the cartridge by pouring the entire toner powder into the cartridge. Use half the bottle now, and the rest at a later time. Overfilling can and will damage a cartridge.

Before opening the bottle of toner, turn it upside down and tap it on a table to loosen the toner and allow it to flow freely. Remove the cap and pull the seal off the bottle. Attach the funnel cap making sure it is on tightly. Tilt the funnel cap toward the filling hole and insert it into the hole. If the toner stops flowing before the cartridge is full, simply remove the toner, close the cap, turn the bottle upside down and tap it on a table. Once the cartridge is full seal the hole with the plug.

Do not press down on the plug since the cartridge is resting on a table this can actually damage the photo-optic drum. Instead hold one end of the cartridge up off the table and twist the plug until it fully sealed. Now gently shake the cartridge side to side to distribute the toner.

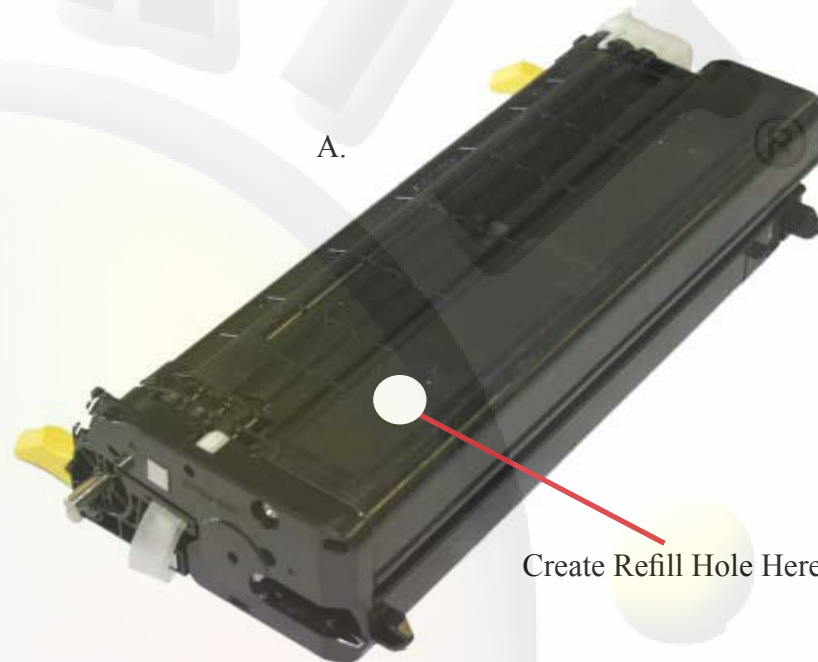

Remove the OEM chip on the cartridge and replace it with a Uni-kit replacement chip.

*Note: Please be advise that our replacement chips do not look like the originals, but have the same function.*



Please be advised that some toner refill kits may be compatible with multiple toner cartridges.



Epson – S051023

[CLICK HERE TO GO THE INDEX](#)

#### REQUIRED FOR A SUCCESSFUL REFILL:

- Toner
- 1 funnel cap
- 1 hole plug
- Toner Hole Making Tool

#### *General Refilling Procedures:*

Use a Flathead screwdriver to pop out the large plastic plug found on the side of the cartridge.

Before opening the bottle of toner, turn it upside down and tap it on a table to loosen the toner and allow it to flow freely. Remove the cap and pull the seal off the bottle. Attach the funnel cap making to sure it is on tightly. Tilt the funnel cap toward the filling hole and insert it into the hole. If the toner stops flowing before the cartridge is full, simply remove the toner, close the cap, turn the bottle upside down and tap it on a table. Once the cartridge is full, seal the hole with the plug by twisting it until it is completely seated. Now gently shake the cartridge side to side to distribute the toner.

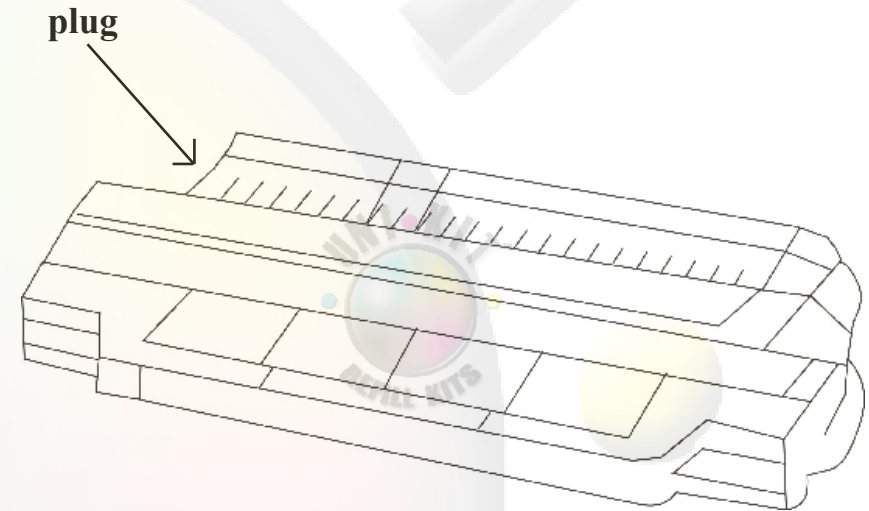

Please be advised that some toner refill kits may be compatible with multiple toner cartridges.



[CLICK HERE TO GO THE INDEX](#)

Epson – S051009/S051200  
Panasonic – FQU160  
NEC – 20055  
Minolta – 0910802/0910803

#### REQUIRED FOR A SUCCESSFUL REFILL:

- Toner
- 1 funnel cap
- 1 hole plug
- Toner Hole Making Tool

#### *General Refilling Procedures:*

Rest the Hole Making Tool on its stand and plug into an outlet. Wait 3 full minutes before using. Position the copper bit on the cartridge in the spot indicated by the photograph and push gently until it melts a hole in the cartridge. Make sure to keep the hole on the flat surface of the cartridge and not on the curved edge. Remove the tool, place it back on its stand and unplug it. If the small piece of plastic has fallen into the cartridge, it must be removed, as this can damage your cartridge or cause print defects. If the piece remains in the tool, wait for the tool to cool down and pry it out.

Before opening the bottle of toner, turn it upside down and tap it on a table to loosen the toner and allow it to flow freely. Remove the cap and pull the seal off the bottle. Attach the funnel cap making sure it is on tightly. Tilt the funnel cap toward the filling hole and insert it into the hole. If the toner stops flowing before the cartridge is full, simply remove the toner, close the cap, turn the bottle upside down and tap it on a table. Once the cartridge is full seal the hole with the plug.

Do not press down on the plug since the cartridge is resting on a table this can actually damage the photo-optic drum. Instead hold one end of the cartridge up off the table and twist the plug until it fully sealed. Now gently shake the cartridge side to side to distribute the toner.



Please be advised that some toner refill kits may be compatible with multiple toner cartridges.



Epson – S0500100  
NEC – 20120/20122  
Minolta – 1710511001/1410399002/171040500  
2/4152601/4152301

[CLICK HERE TO GO THE INDEX](#)

#### REQUIRED FOR A SUCCESSFUL REFILL:

- Toner
- 1 funnel cap
- Hole Making Tool

#### *General Refilling Procedures:*

Rest the Hole Making Tool on its stand and plug into an outlet. Wait 3 full minutes before using. Position the copper bit on the cartridge in the spot indicated by the photograph and push gently until it melts a hole in the cartridge. Remove the tool, place it back on its stand and unplug it. If the small piece of plastic has fallen into the cartridge, it must be removed, as this can damage your cartridge or cause print defects. If the piece remains in the tool, wait for the tool to cool down and pry it out.

Before opening the bottle of toner, turn it upside down and tap it on a table to loosen the toner and allow it to flow freely. Remove the cap and pull the seal off the bottle. Attach the funnel cap making sure it is on tightly. Tilt the funnel cap toward the filling hole and insert it into the hole. If the toner stops flowing before the cartridge is full, simply remove the toner, close the cap, turn the bottle upside down and tap it on a table. Once the cartridge is full, seal the hole with the plug by twisting it until it is completely seated. Now gently shake the cartridge side to side to distribute the toner.

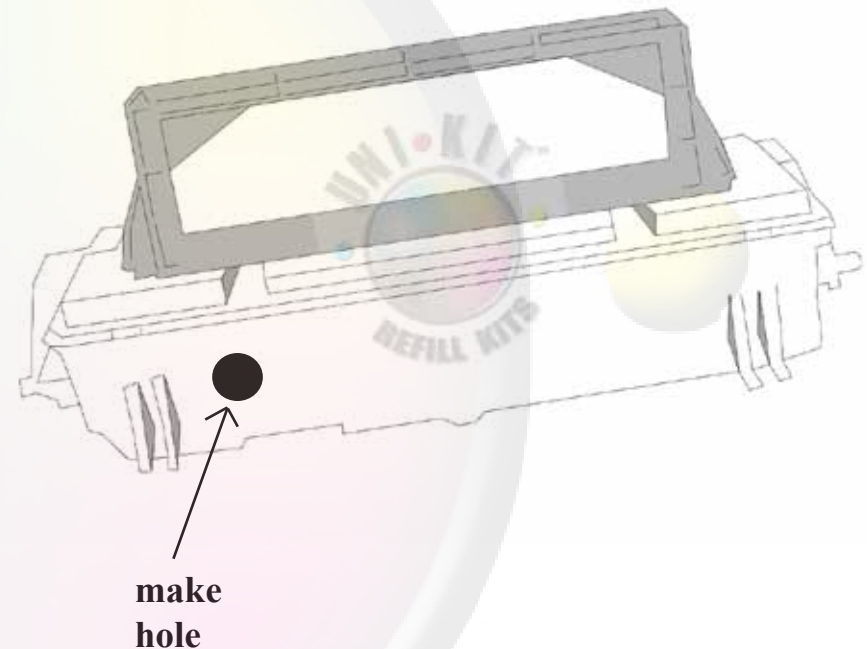

Please be advised that some toner refill kits may be compatible with multiple toner cartridges.



Epson S051016  
Epson S051011  
DEC LN11XAA  
Minolta 0927605, 0927606

[CLICK HERE TO GO THE INDEX](#)

#### REQUIRED FOR A SUCCESSFUL REFILL:

- Toner
- 1 funnel cap
- 1 hole plug
- Toner Hole Making Tool

#### *General Refilling Procedures:*

1. Remove the plug from the side of the cartridge by using a screwdriver, thereby exposing the fill hole.
2. Refill by pouring toner into the fill hole through the nozzle attached to the toner bottle.
3. Replace the plug when finished refilling.

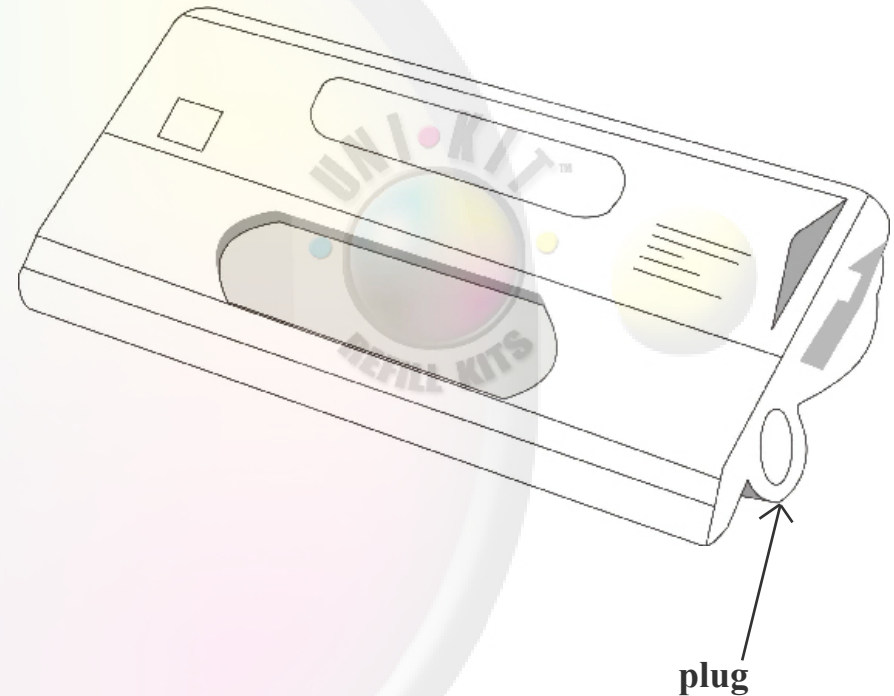



Please be advised that some toner refill kits may be compatible with multiple toner cartridges.



[CLICK HERE TO GO THE INDEX](#)

HP - C3903A  
Canon – FX4  
Xerox - 6R905

#### REQUIRED FOR A SUCCESSFUL REFILL:

- Toner
- 1 funnel cap
- 1 hole plug
- Toner Hole Making Tool

#### *General Refilling Procedures:*

Rest the Hole Making Tool on its stand and plug into an outlet. Wait 3 full minutes before using. Position the copper bit on the cartridge in the spot indicated by the photograph and push gently until it melts a hole in the cartridge. Remove the tool, place it back on its stand and unplug it. If the small piece of plastic has fallen into the cartridge, it must be removed, as this can damage your cartridge or cause print defects. If the piece remains in the tool, wait for the tool to cool down and pry it out.

Before opening the bottle of toner, turn it upside down and tap it on a table to loosen the toner and allow it to flow freely. Remove the cap and pull the seal off the bottle. Attach the funnel cap making sure it is on tightly. Tilt the funnel cap toward the filling hole and insert it into the hole. If the toner stops flowing before the cartridge is full, simply remove the toner, close the cap, turn the bottle upside down and tap it on a table. Once the cartridge is full seal the hole with the plug.

Do not press down on the plug since the cartridge is resting on a table this can actually damage the photo-optic drum. Instead hold one end of the cartridge up off the table and twist the plug until it fully sealed. Now gently shake the cartridge side to side to distribute the toner.



Please be advised that some toner refill kits may be compatible with multiple toner cartridges.



[CLICK HERE TO GO THE INDEX](#)

HP - 92298A / X  
Canon - EPE  
Canon - FX5  
Apple - M2473A / G  
DEC - LN0XXAA  
Lexmark- 140198A / X

#### REQUIRED FOR A SUCCESSFUL REFILL:

- Toner
- 1 funnel cap
- 1 hole plug
- Toner Hole Making Tool

#### *General Refilling Procedures:*

Rest the Hole Making Tool on its stand and plug into an outlet. Wait 3 full minutes before using. Position the copper bit on the cartridge in the spot indicated by the photograph and push gently until it melts a hole in the cartridge. Remove the tool, place it back on its stand and unplug it. If the small piece of plastic has fallen into the cartridge, it must be removed, as this can damage your cartridge or cause print defects. If the piece remains in the tool, wait for the tool to cool down and pry it out.

Before opening the bottle of toner, turn it upside down and tap it on a table to loosen the toner and allow it to flow freely. Remove the cap and pull the seal off the bottle. Attach the funnel cap making to sure it is on tightly. Tilt the funnel cap toward the filling hole and insert it into the hole. If the toner stops flowing before the cartridge is full, simply remove the toner, close the cap, turn the bottle upside down and tap it on a table. Once the cartridge is full seal the hole with the plug.

Do not press down on the plug since the cartridge is resting on a table this can actually damage the photo-optic drum. Instead hold one end of the cartridge up off the table and twist the plug until it fully sealed. Now gently shake the cartridge side to side to distribute the toner.



Please be advised that some toner refill kits may be compatible with multiple toner cartridges.



[CLICK HERE TO GO THE INDEX](#)

HP – C3906A  
Canon – EPA  
Canon – FX3  
Xerox – 6R908

#### REQUIRED FOR A SUCCESSFUL REFILL:

- Toner
- 1 funnel cap
- 1 hole plug
- Toner Hole Making Tool

#### *General Refilling Procedures:*

Rest the Hole Making Tool on its stand and plug into an outlet. Wait 3 full minutes before using. Position the copper bit on the cartridge in the spot indicated by the photograph and push gently until it melts a hole in the cartridge. Make sure to keep the hole on the flat surface of the cartridge and not on the curved edge. Remove the tool, place it back on its stand and unplug it. If the small piece of plastic has fallen into the cartridge, it must be removed, as this can damage your cartridge or cause print defects. If the piece remains in the tool, wait for the tool to cool down and pry it out.

Before opening the bottle of toner, turn it upside down and tap it on a table to loosen the toner and allow it to flow freely. Remove the cap and pull the seal off the bottle. Attach the funnel cap making to sure it is on tightly. Tilt the funnel cap toward the filling hole and insert it into the hole. If the toner stops flowing before the cartridge is full, simply remove the toner, close the cap, turn the bottle upside down and tap it on a table. Once the cartridge is full seal the hole with the plug.

Do not press down on the plug since the cartridge is resting on a table this can actually damage the photo-optic drum. Instead hold one end of the cartridge up off the table and twist the plug until it fully sealed. Now gently shake the cartridge side to side to distribute the toner.

**NOTE:** If after the cartridge is refilled and it starts to print gray smudges or smears along the margin, the waste hopper could be full. Please refer to the supplemental instructions (page 2) for emptying the waste hopper.



Please be advised that some toner refill kits may be compatible with multiple toner cartridges.



[CLICK HERE TO GO THE INDEX](#)

HP – C4092A  
Xerox – 6R927

#### REQUIRED FOR A SUCCESSFUL REFILL:

- Toner
- 1 funnel cap
- 1 hole plug
- Toner Hole Making Tool

#### General Refilling Procedures:

Rest the Hole Making Tool on its stand and plug into an outlet. Wait 3 full minutes before using. Position the copper bit on the cartridge in the spot indicated by the photograph and push gently until it melts a hole in the cartridge. Make sure to keep the hole on the flat surface of the cartridge and not on the curved edge. Remove the tool, place it back on its stand and unplug it. If the small piece of plastic has fallen into the cartridge, it must be removed, as this can damage your cartridge or cause print defects. If the piece remains in the tool, wait for the tool to cool down and pry it out.

Before opening the bottle of toner, turn it upside down and tap it on a table to loosen the toner and allow it to flow freely. Remove the cap and pull the seal off the bottle. Attach the funnel cap making sure it is on tightly. Tilt the funnel cap toward the filling hole and insert it into the hole. If the toner stops flowing before the cartridge is full, simply remove the toner, close the cap, turn the bottle upside down and tap it on a table. Once the cartridge is full seal the hole with the plug.

Do not press down on the plug since the cartridge is resting on a table this can actually damage the photo-optic drum. Instead hold one end of the cartridge up off the table and twist the plug until it fully sealed. Now gently shake the cartridge side to side to distribute the toner.

**NOTE:** If after the cartridge is refilled and it starts to print gray smudges or smears along the margin, the waste hopper could be full. Please refer to the supplemental instructions (page 2) for emptying the waste hopper.





Please be advised that some toner refill kits may be compatible with multiple toner cartridges.



[CLICK HERE TO GO THE INDEX](#)

HP – C4096A  
Xerox – 6R928

#### REQUIRED FOR A SUCCESSFUL REFILL:

- Toner
- 1 funnel cap
- 1 hole plug
- Toner Hole Making Tool

#### *General Refilling Procedures:*

Rest the Hole Making Tool on its stand and plug into an outlet. Wait 3 full minutes before using. Remove the label using a Flathead screwdriver. Position the copper bit on the cartridge in the spot indicated by the photograph and push gently until it melts a hole in the cartridge. Remove the tool, place it back on its stand and unplug it. If the small piece of plastic has fallen into the cartridge, it must be removed, as this can damage your cartridge or cause print defects. If the piece remains in the tool, wait for the tool to cool down and pry it out.

Before opening the bottle of toner, turn it upside down and tap it on a table to loosen the toner and allow it to flow freely. Remove the cap and pull the seal off the bottle. Attach the funnel cap making sure it is on tightly. Tilt the funnel cap toward the filling hole and insert it into the hole. If the toner stops flowing before the cartridge is full, simply remove the toner, close the cap, turn the bottle upside down and tap it on a table. Once the cartridge is full seal the hole with the plug.

Do not press down on the plug since the cartridge is resting on a table this can actually damage the photo-optic drum. Instead hold one end of the cartridge up off the table and twist the plug until it fully sealed. Now gently shake the cartridge side to side to distribute the toner.

**NOTE:** If after the cartridge is refilled and it starts to print gray smudges or smears along the margin, the waste hopper could be full.



Please be advised that some toner refill kits may be compatible with multiple toner cartridges.



[CLICK HERE TO GO THE INDEX](#)

Standard Capacity Cartridges  
HP- C4127A  
Canon – EP52 (Standard yield)  
Brother – TN9500 (Standard yield)

#### REQUIRED FOR A SUCCESSFUL REFILL:

- Toner
- 1 funnel cap
- 1 hole plug
- Toner Hole Making Tool

#### General Refilling Procedures:

**Note:** Follow these instructions if you are unsure if your cartridge is a standard yield or high yield cartridge.

Rest the Hole Making Tool on its stand and plug into an outlet. Wait 3 full minutes before using. Turn the cartridge over. Position the copper bit on the cartridge in the spot just right of the “waffle” design as indicated by the photograph and push gently until it melts a hole in the cartridge. Remove the tool, place it back on its stand and unplug it. If the small piece of plastic has fallen into the cartridge, it must be removed, as this can damage your cartridge or cause print defects. If the piece remains in the tool, wait for the tool to cool down and pry it out.

Before opening the bottle of toner, turn it upside down and tap it on a table to loosen the toner and allow it to flow freely. Remove the cap and pull the seal off the bottle. Attach the funnel cap making sure it is on tightly. Tilt the funnel cap toward the filling hole and insert it into the hole. If the toner stops flowing before the cartridge is full, simply remove the toner, close the cap, turn the bottle upside down and tap it on a table. Once the cartridge is full seal the hole with the plug.

Do not press down on the plug since the cartridge is resting on a table this can actually damage the photo-optic drum. Instead hold one end of the cartridge up off the table and twist the plug until it fully sealed. Now gently shake the cartridge side to side to distribute the toner.

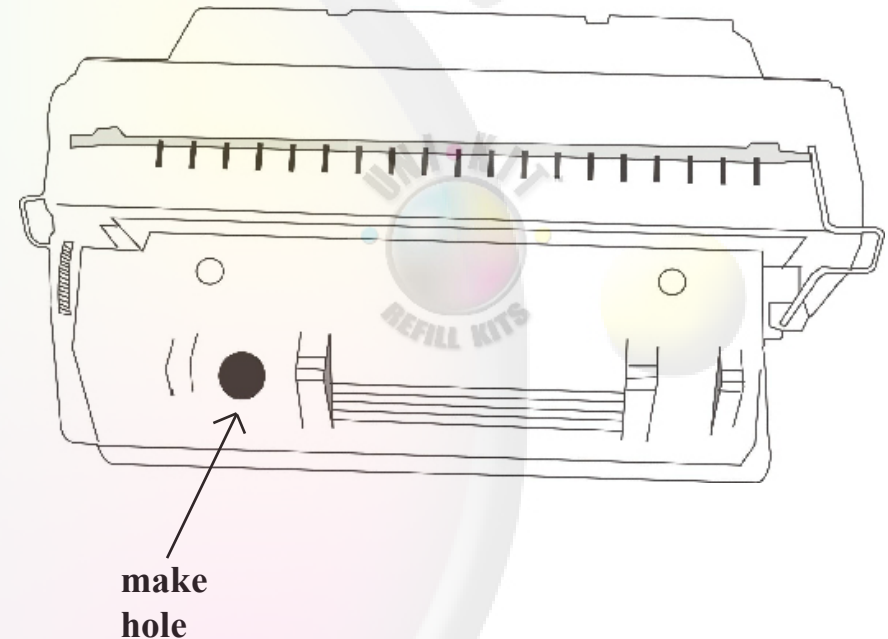

Please be advised that some toner refill kits may be compatible with multiple toner cartridges.



[CLICK HERE TO GO THE INDEX](#)

High Capacity Cartridges  
HP- C4127X  
Canon – EP52 (high yield)  
Brother – TN9500 (high yield)  
Xerox 6R926

#### REQUIRED FOR A SUCCESSFUL REFILL:

- Toner
- 1 funnel cap
- 1 hole plug
- Toner Hole Making Tool

#### *General Refilling Procedures:*

**Note:** If you have the standard capacity cartridge, please follow the instructions for the standard capacity cartridge.

Rest the Hole Making Tool on its stand and plug into an outlet. Wait 3 full minutes before using. Position the copper bit on the cartridge in the spot indicated by the photograph and push gently until it melts a hole in the cartridge. Remove the tool, place it back on its stand and unplug it. If the small piece of plastic has fallen into the cartridge, it must be removed, as this can damage your cartridge or cause print defects. If the piece remains in the tool, wait for the tool to cool down and pry it out.

Before opening the bottle of toner, turn it upside down and tap it on a table to loosen the toner and allow it to flow freely. Remove the cap and pull the seal off the bottle. Attach the funnel cap making sure it is on tightly. Tilt the funnel cap toward the filling hole and insert it into the hole. If the toner stops flowing before the cartridge is full, simply remove the toner, close the cap, turn the bottle upside down and tap it on a table. Once the cartridge is full seal the hole with the plug.

Do not press down on the plug since the cartridge is resting on a table this can actually damage the photo-optic drum. Instead hold one end of the cartridge up off the table and twist the plug until it fully sealed. Now gently shake the cartridge side to side to distribute the toner.



Please be advised that some toner refill kits may be compatible with multiple toner cartridges.



[CLICK HERE TO GO THE INDEX](#)

HP – C7115A/X  
Xerox – 6R932

#### REQUIRED FOR A SUCCESSFUL REFILL:

- Toner
- 1 funnel cap
- 1 hole plug
- Toner Hole Making Tool

#### *General Refilling Procedures:*

Rest the Hole Making Tool on its stand and plug into an outlet. Wait 3 full minutes before using. Position the copper bit on the cartridge in the spot indicated by the photograph and push gently until it melts a hole in the cartridge. Make sure to keep the hole on the flat surface of the cartridge and not on the curved edge. Remove the tool, place it back on its stand and unplug it. If the small piece of plastic has fallen into the cartridge, it must be removed, as this can damage your cartridge or cause print defects. If the piece remains in the tool, wait for the tool to cool down and pry it out.

Before opening the bottle of toner, turn it upside down and tap it on a table to loosen the toner and allow it to flow freely. Remove the cap and pull the seal off the bottle. Attach the funnel cap making to sure it is on tightly. Tilt the funnel cap toward the filling hole and insert it into the hole. If the toner stops flowing before the cartridge is full, simply remove the toner, close the cap, turn the bottle upside down and tap it on a table. Once the cartridge is full seal the hole with the plug.

Do not press down on the plug since the cartridge is resting on a table this can actually damage the photo-optic drum. Instead hold one end of the cartridge up off the table and twist the plug until it fully sealed. Now gently shake the cartridge side to side to distribute the toner.





Please be advised that some toner refill kits may be compatible with multiple toner cartridges.



HP – C7115X

[CLICK HERE TO GO THE INDEX](#)

#### REQUIRED FOR A SUCCESSFUL REFILL:

- Toner
- 1 funnel cap
- 1 hole plug
- Toner Hole Making Tool

#### *General Refilling Procedures:*

Rest the Hole Making Tool on its stand and plug into an outlet. Wait 3 full minutes before using. Position the copper bit on the cartridge in the spot indicated by the photograph and push gently until it melts a hole in the cartridge. Make sure to keep the hole on the flat surface of the cartridge and not on the curved edge. Remove the tool, place it back on its stand and unplug it. If the small piece of plastic has fallen into the cartridge, it must be removed, as this can damage your cartridge or cause print defects. If the piece remains in the tool, wait for the tool to cool down and pry it out.

Before opening the bottle of toner, turn it upside down and tap it on a table to loosen the toner and allow it to flow freely. Remove the cap and pull the seal off the bottle. Attach the funnel cap making sure it is on tightly. Tilt the funnel cap toward the filling hole and insert it into the hole. If the toner stops flowing before the cartridge is full, simply remove the toner, close the cap, turn the bottle upside down and tap it on a table. Once the cartridge is full seal the hole with the plug.

Do not press down on the plug since the cartridge is resting on a table this can actually damage the photo-optic drum. Instead hold one end of the cartridge up off the table and twist the plug until it fully sealed. Now gently shake the cartridge side to side to distribute the toner.



Please be advised that some toner refill kits may be compatible with multiple toner cartridges.



[CLICK HERE TO GO THE INDEX](#)

HP – C8061X  
Xerox – 6R933

#### REQUIRED FOR A SUCCESSFUL REFILL:

- Toner
- 1 funnel cap
- 1 hole plug
- Toner Hole Making Tool

#### *General Refilling Procedures:*

Rest the Hole Making Tool on its stand and plug into an outlet. Wait 3 full minutes before using. Position the copper bit on the cartridge in the spot indicated by the photograph and push gently until it melts a hole in the cartridge. Make sure to keep the hole on the flat surface of the cartridge and not on the curved edge. Remove the tool, place it back on its stand and unplug it. If the small piece of plastic has fallen into the cartridge, it must be removed, as this can damage your cartridge or cause print defects. If the piece remains in the tool, wait for the tool to cool down and pry it out.

Before opening the bottle of toner, turn it upside down and tap it on a table to loosen the toner and allow it to flow freely. Remove the cap and pull the seal off the bottle. Attach the funnel cap making to sure it is on tightly. Tilt the funnel cap toward the filling hole and insert it into the hole. If the toner stops flowing before the cartridge is full, simply remove the toner, close the cap, turn the bottle upside down and tap it on a table. Once the cartridge is full seal the hole with the plug.

Do not press down on the plug since the cartridge is resting on a table this can actually damage the photo-optic drum. Instead hold one end of the cartridge up off the table and twist the plug until it fully sealed. Now gently shake the cartridge side to side to distribute the toner.



Please be advised that some toner refill kits may be compatible with multiple toner cartridges.



HP – Q2610A

[CLICK HERE TO GO THE INDEX](#)

#### REQUIRED FOR A SUCCESSFUL REFILL:

- Toner (
- 1 funnel cap
- 1 hole plug
- Toner Hole Making Tool

#### *General Refilling Procedures:*

Rest the Hole Making Tool on its stand and plug into an outlet. Wait 3 full minutes before using. Position the copper bit on the cartridge in the spot indicated by the photograph and push gently until it melts a hole in the cartridge. Remove the tool, place it back on its stand and unplug it. If the small piece of plastic has fallen into the cartridge, it must be removed, as this can damage your cartridge or cause print defects. If the piece remains in the tool, wait for the tool to cool down and pry it out.

Before opening the bottle of toner, turn it upside down and tap it on a table to loosen the toner and allow it to flow freely. Remove the cap and pull the seal off the bottle. Attach the funnel cap making to sure it is on tightly. Tilt the funnel cap toward the filling hole and insert it into the hole. If the toner stops flowing before the cartridge is full, simply remove the toner, close the cap, turn the bottle upside down and tap it on a table. Once the cartridge is full seal the hole with the plug.

Do not press down on the plug since the cartridge is resting on a table this can actually damage the photo-optic drum. Instead hold one end of the cartridge up off the table and twist the plug until it fully sealed. Now gently shake the cartridge side to side to distribute the toner.

**NOTE:** If after the cartridge is refilled and it starts to print gray smudges or smears along the margin, the waste hopper could be full. Please refer to the supplemental instructions (page 2) for emptying the waste hopper.



Please be advised that some toner refill kits may be compatible with multiple toner cartridges.



HP Q2612A/X

[CLICK HERE TO GO THE INDEX](#)

#### REQUIRED FOR A SUCCESSFUL REFILL:

- Toner
- 1 funnel cap
- 1 hole plug
- Toner Hole Making Tool

#### General Refilling Procedures:

Rest the Hole Making Tool on its stand and plug into an outlet. Wait 3 full minutes before using.

Turn the cartridge so that the handle is facing up. Position the copper bit on the cartridge in the spot indicated by the photograph and push gently until it melts a hole in the cartridge. Remove the tool, place it back on its stand and unplug it. If the small piece of plastic has fallen into the cartridge, it must be removed, as this can damage your cartridge or cause print defects. If the piece remains in the tool, wait for the tool to cool down and pry it out.

Before opening the bottle of toner, turn it upside down and tap it on a table to loosen the toner and allow it to flow freely. Remove the cap and pull the seal off the bottle. Attach the funnel cap making to sure it is on tightly. Tilt the funnel cap toward the filling hole and insert it into the hole. If the toner stops flowing before the cartridge is full, simply remove the toner, close the cap, turn the bottle upside down and tap it on a table. Once the cartridge is full seal the hole with the plug.

Do not press down on the plug since the cartridge is resting on a table this can actually damage the photo-optic drum. Instead hold one end of the cartridge up off the table and twist the plug until it fully sealed. Now gently shake the cartridge side to side to distribute the toner.

NOTE: If after the cartridge is refilled and it starts to print gray smudges or smears along the margin, the waste hopper could be full. Please refer to the supplemental instructions (page 2) for emptying the waste hopper.



Refill Hole



Waste Hopper

#### Waste Hopper Instructions for HP Q2612A:

(Do this procedure over a newspaper)

Turn the cartridge the way it would be inserted into the printer. Using the hole making tool, position the copper bit on the cartridge in the spot indicated by the photograph and push gently until it melts a hole in the cartridge. Once the hole has been made, turn the cartridge over so that the hole is facing the newspaper. Gently rock the cartridge back and forth allowing the toner to fall onto the newspaper. Do this repeatedly to remove as much waste toner as possible. Don't worry about getting all of the toner out. Now clean around hole with a soft dry cloth. Use duct tape to seal the hole.



Please be advised that some toner refill kits may be compatible with multiple toner cartridges.



HP – Q2613A / X

[CLICK HERE TO GO THE INDEX](#)

#### REQUIRED FOR A SUCCESSFUL REFILL:

- Toner
- 1 funnel cap
- 1 hole plug
- Toner Hole Making Tool

#### *General Refilling Procedures:*

Rest the Hole Making Tool on its stand and plug into an outlet. Wait 3 full minutes before using. Position the copper bit on the cartridge in the spot indicated by the photograph and push gently until it melts a hole in the cartridge. Remove the tool, place it back on its stand and unplug it. If the small piece of plastic has fallen into the cartridge, it must be removed, as this can damage your cartridge or cause print defects. If the piece remains in the tool, wait for the tool to cool down and pry it out.

Before opening the bottle of toner, turn it upside down and tap it on a table to loosen the toner and allow it to flow freely. Remove the cap and pull the seal off the bottle. Attach the funnel cap making to sure it is on tightly. Tilt the funnel cap toward the filling hole and insert it into the hole. If the toner stops flowing before the cartridge is full, simply remove the toner, close the cap, turn the bottle upside down and tap it on a table. Once the cartridge is full seal the hole with the plug.

Do not press down on the plug since the cartridge is resting on a table this can actually damage the photo-optic drum. Instead hold one end of the cartridge up off the table and twist the plug until it fully sealed. Now gently shake the cartridge side to side to distribute the toner.



Please be advised that some toner refill kits may be compatible with multiple toner cartridges.



HP – Q2624A

[CLICK HERE TO GO THE INDEX](#)

#### REQUIRED FOR A SUCCESSFUL REFILL:

- Toner
- 1 funnel cap
- 1 hole plug
- Toner Hole Making Tool

#### *General Refilling Procedures:*

Rest the Hole Making Tool on its stand and plug into an outlet. Wait 3 full minutes before using. Position the copper bit on the cartridge in the spot indicated by the photograph and push gently until it melts a hole in the cartridge. Make sure to keep the hole on the flat surface of the cartridge and not on the curved edge. Remove the tool, place it back on its stand and unplug it. If the small piece of plastic has fallen into the cartridge, it must be removed, as this can damage your cartridge or cause print defects. If the piece remains in the tool, wait for the tool to cool down and pry it out.

Before opening the bottle of toner, turn it upside down and tap it on a table to loosen the toner and allow it to flow freely. Remove the cap and pull the seal off the bottle. Attach the funnel cap making to sure it is on tightly. Tilt the funnel cap toward the filling hole and insert it into the hole. If the toner stops flowing before the cartridge is full, simply remove the toner, close the cap, turn the bottle upside down and tap it on a table. Once the cartridge is full seal the hole with the plug.

Do not press down on the plug since the cartridge is resting on a table this can actually damage the photo-optic drum. Instead hold one end of the cartridge up off the table and twist the plug until it fully sealed. Now gently shake the cartridge side to side to distribute the toner.

**NOTE:** If after the cartridge is refilled and it starts to print gray smudges or smears along the margin, the waste hopper could be full. Please refer to the supplemental instructions (page 2) for emptying the waste hopper.



Please be advised that some toner refill kits may be compatible with multiple toner cartridges.



HP P3015

[CLICK HERE TO GO THE INDEX](#)

#### REQUIRED FOR A SUCCESSFUL REFILL:

- Toner
- 1 funnel cap
- 1 hole plug (duct tape or electrical can be used as substitute)
- Toner Hole Making Tool

#### *General Refilling Procedures:*

Rest the Hole Making Tool on its stand and plug into an outlet. Wait 3 full minutes before using. Position the copper bit on the cartridge in the spot indicated by the photograph and push gently until it melts a hole in the cartridge. Remove the tool, place it back on its stand and unplug it. If the small piece of plastic has fallen into the cartridge, it must be removed, as this can damage your cartridge or cause print defects. If the piece remains in the tool, wait for the tool to cool down and pry it out.

Before opening the bottle of toner, turn it upside down and tap it on a table to loosen the toner and allow it to flow freely. Remove the cap and pull the seal off the bottle. Attach the funnel cap making to sure it is on tightly. Tilt the funnel cap toward the filling hole and insert it into the hole. If the toner stops flowing before the cartridge is full, simply remove the toner, close the cap, turn the bottle upside down and tap it on a table. Once the cartridge is full seal the hole with the plug, duct tape, or electrical tape.

Do not press down on the plug since the cartridge is resting on a table this can actually damage the photo-optic drum. Instead hold one end of the cartridge up off the table and twist the plug until it fully sealed. Now gently shake the cartridge side to side to distribute the toner.

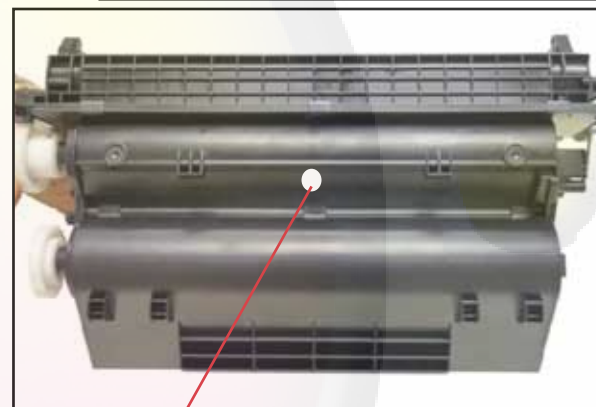

Create Refill Hole Here

When replacing the chip, clip both ends (circled in red in the picture to the right) to help remove it from the slot. You may use a small amount of hot glue near the top ends to hold the new chip in place.

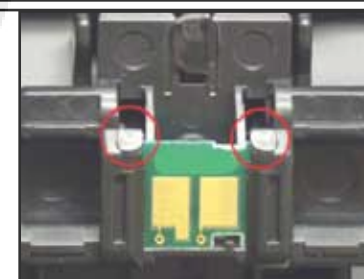



Please be advised that some toner refill kits may be compatible with multiple toner cartridges.



HP CC364

[CLICK HERE TO GO THE INDEX](#)

#### REQUIRED FOR A SUCCESSFUL REFILL:

- Toner
- 1 Phillips screwdriver and flat head screw driver
- Needle nose pliers

Note: Please read carefully before refilling cartridge.

#### General Refilling Procedures:

Using the screw driver, remove the screws on the side of the cartridge so that the sealing plug can be revealed (Picture A.). Once you have located the sealing plug, use the flat head screw driver to gently loosen the sealing plug (Picture B.). With the needle nose pliers, gently, but forcefully pull the plug completely off the cartridge. If the plug happens to bent or crack, you may use electrical tape or duct tape to securely seal the cracks or bents once you have replaced the plug at the end of the refill process.

Empty any toner left inside the cartridge (mixing two different brands of toners could result in bad printing, and unpredictable results).

Before opening the bottle of toner, turn it upside down and tap it on a table to loosen the toner and allow it to flow freely. Remove the cap and pull the seal off the bottle. Attach the funnel cap making to sure it is on tightly. Tilt the cartridge at a 45 degree angle and then the funnel cap toward the filling hole and insert it into the hole. If the toner stops flowing before the cartridge is full, simply remove the toner, close the cap, turn the bottle upside down and tap it on a table. Once you are done refilling this cartridge, place the sealing plug back in its place and use duct tape or electrical tape to seal up any necessary cracks on the plug.

Replace the Smart Chip on the cartridge before placing it back into the printer. The chip may need to be pryed from its location gently. Once the chip has been replaced, insert the cartridge into the printer and run a few test pages.



A.

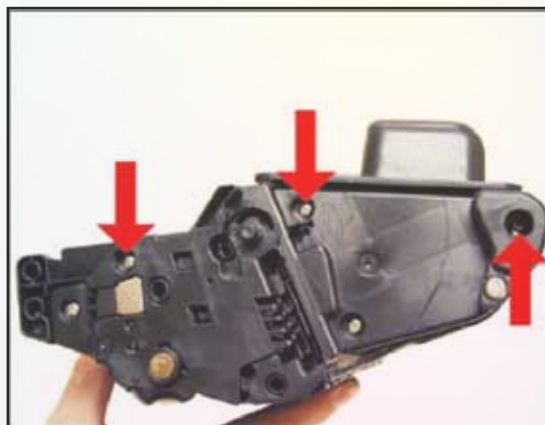

B.



C.





Please be advised that some toner refill kits may be compatible with multiple toner cartridges.



HP – Q5949A

[CLICK HERE TO GO THE INDEX](#)

#### REQUIRED FOR A SUCCESSFUL REFILL:

- Toner
- 1 funnel cap
- 1 hole plug
- Toner Hole Making Tool

#### General Refilling Procedures:

Rest the Hole Making Tool on its stand and plug into an outlet. Wait 3 full minutes before using. Position the copper bit on the cartridge in the spot indicated by the photograph and push gently until it melts a hole in the cartridge. Remove the tool, place it back on its stand and unplug it. If the small piece of plastic has fallen into the cartridge, it must be removed, as this can damage your cartridge or cause print defects. If the piece remains in the tool, wait for the tool to cool down and pry it out.

Before opening the bottle of toner, turn it upside down and tap it on a table to loosen the toner and allow it to flow freely. Remove the cap and pull the seal off the bottle. Attach the funnel cap making to sure it is on tightly. Tilt the funnel cap toward the filling hole and insert it into the hole. If the toner stops flowing before the cartridge is full, simply remove the toner, close the cap, turn the bottle upside down and tap it on a table. Once the cartridge is full seal the hole with the plug.

Do not press down on the plug since the cartridge is resting on a table this can actually damage the photo-optic drum. Instead hold one end of the cartridge up off the table and twist the plug until it fully sealed. Now gently shake the cartridge side to side to distribute the toner.

**NOTE:** If after the cartridge is refilled and it starts to print gray smudges or smears along the margin, the waste hopper could be full. Please refer to the supplemental instructions (page 2) for emptying the waste hopper.

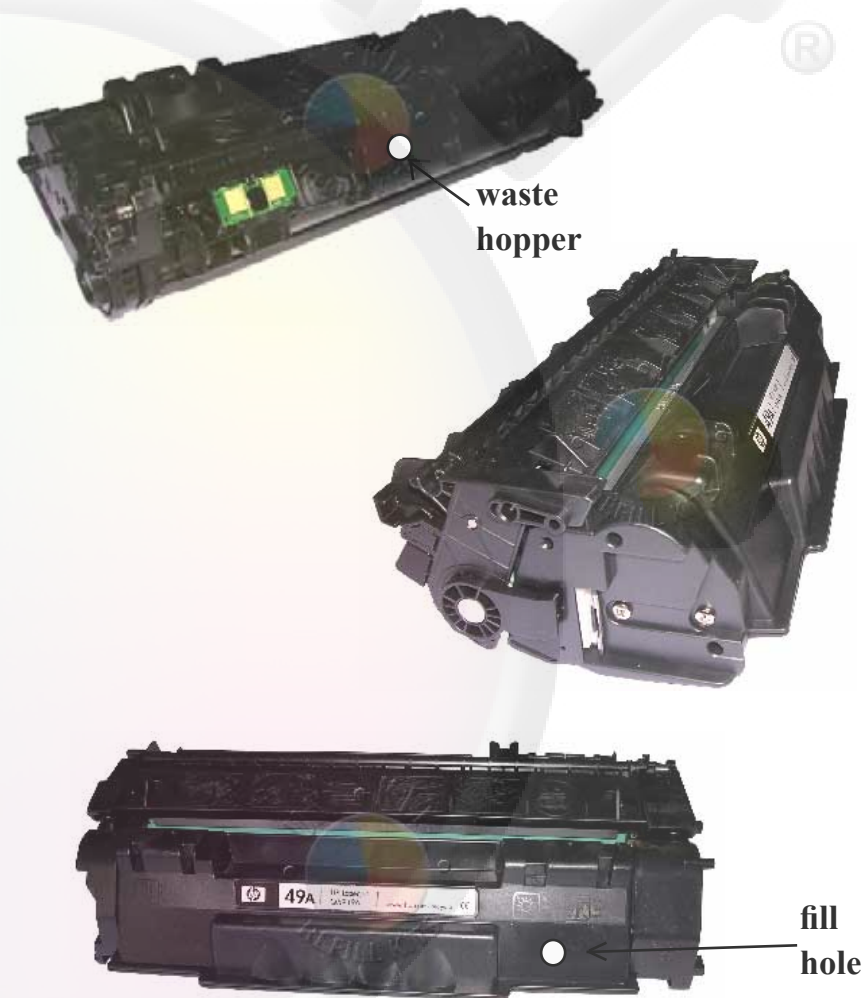

Please be advised that some toner refill kits may be compatible with multiple toner cartridges.



HP – 92291A

[CLICK HERE TO GO THE INDEX](#)

#### REQUIRED FOR A SUCCESSFUL REFILL:

- Toner
- 1 funnel cap
- 1 hole plug
- Toner Hole Making Tool

#### *General Refilling Procedures:*

Rest the Hole Making Tool on its stand and plug into an outlet. Wait 3 full minutes before using. Position the copper bit on the cartridge in the spot indicated by the photograph and push gently until it melts a hole in the cartridge. Make sure to keep the hole on the flat surface of the cartridge and not on the curved edge. Remove the tool, place it back on its stand and unplug it. If the small piece of plastic has fallen into the cartridge, it must be removed, as this can damage your cartridge or cause print defects. If the piece remains in the tool, wait for the tool to cool down and pry it out.

Before opening the bottle of toner, turn it upside down and tap it on a table to loosen the toner and allow it to flow freely. Remove the cap and pull the seal off the bottle. Attach the funnel cap making to sure it is on tightly. Tilt the funnel cap toward the filling hole and insert it into the hole. If the toner stops flowing before the cartridge is full, simply remove the toner, close the cap, turn the bottle upside down and tap it on a table. Once the cartridge is full seal the hole with the plug.

Do not press down on the plug since the cartridge is resting on a table this can actually damage the photo-optic drum. Instead hold one end of the cartridge up off the table and twist the plug until it fully sealed. Now gently shake the cartridge side to side to distribute the toner.

**NOTE:** If after the cartridge is refilled and it starts to print gray smudges or smears along the margin, the waste hopper could be full. Please refer to the supplemental instructions (page 2) for emptying the waste hopper.

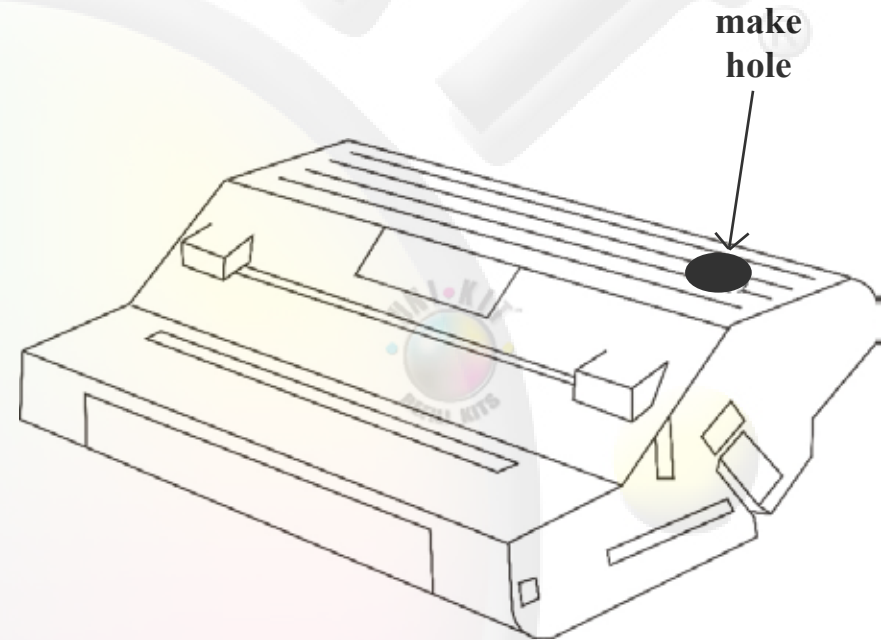

Please be advised that some toner refill kits may be compatible with multiple toner cartridges.



HP – Q1338A / Q1339A

[CLICK HERE TO GO THE INDEX](#)

#### REQUIRED FOR A SUCCESSFUL REFILL:

- Toner
- 1 funnel cap
- 1 hole plug (electrical or duct tape will do as well)
- Toner Hole Making Tool

#### General Refilling Procedures:

Rest the Hole Making Tool on its stand and plug into an outlet. Wait 3 full minutes before using. Position the copper bit on the cartridge in the spot indicated in photograph A and push gently until it melts a hole in the cartridge. Make sure to keep the hole on the flat surface of the cartridge and not on the curved edge. Remove the tool, place it back on its stand and unplug it. If the small piece of plastic has fallen into the cartridge, it must be removed, as this can damage your cartridge or cause print defects. If the piece remains in the tool, wait for the tool to cool down and pry it out.

**IMPORTANT:** You must dispose of any original toner in the cartridge as much as possible before refilling. Dispose of toner properly into a trash can, or use a vacuum with a hose for best results (if possible).

Before opening the bottle of toner, turn it upside down and tap it on a table to loosen the toner and allow it to flow freely. Remove the cap and pull the seal off the bottle. Attach the funnel cap making to sure it is on tightly. Tilt the funnel cap toward the filling hole and insert it into the hole. If the toner stops flowing before the cartridge is full, simply remove the toner, close the cap, turn the bottle upside down and tap it on a table. Once the cartridge is full seal the hole with the plug.

Do not press down on the plug since the cartridge is resting on a table this can actually damage the photo-optic drum. Instead hold one end of the cartridge up off the table and twist the plug until it fully sealed. Now gently shake the cartridge side to side to distribute the toner.



Create Refill hole here





Please be advised that some toner refill kits may be compatible with multiple toner cartridges.



[CLICK HERE TO GO THE INDEX](#)

Xerox - 6R929/6R0906  
HP - C4127AX/C3909A/C4182AX  
Minolta - 171046601/171046001  
Lexmark - 1382140  
IBM - 63H5721  
Canon - EPW/EP72

#### REQUIRED FOR A SUCCESSFUL REFILL:

- Toner
- 1 funnel cap
- 1 hole plug
- Toner Hole Making Tool

#### *General Refilling Procedures:*

Rest the Hole Making Tool on its stand and plug into an outlet. Wait 3 full minutes before using. Turn the cartridge up in its left side. Position the copper bit on the cartridge in the spot indicated by the photograph and push gently until it melts a hole in the cartridge. Make sure to keep the hole on the flat surface of the cartridge and not on the curved edge. Remove the tool, place it back on its stand and unplug it. If the small piece of plastic has fallen into the cartridge, it must be removed, as this can damage your cartridge or cause print defects. If the piece remains in the tool, wait for the tool to cool down and pry it out.

Before opening the bottle of toner, turn it upside down and tap it on a table to loosen the toner and allow it to flow freely. Remove the cap and pull the seal off the bottle. Attach the funnel cap making to sure it is on tightly. Tilt the funnel cap toward the filling hole and insert it into the hole. If the toner stops flowing before the cartridge is full, simply remove the toner, close the cap, turn the bottle upside down and tap it on a table. Once the cartridge is full seal the hole with the plug.

Do not press down on the plug since the cartridge is resting on a table this can actually damage the photo-optic drum. Instead hold one end of the cartridge up off the table and twist the plug until it fully sealed. Now gently shake the cartridge side to side to distribute the toner.

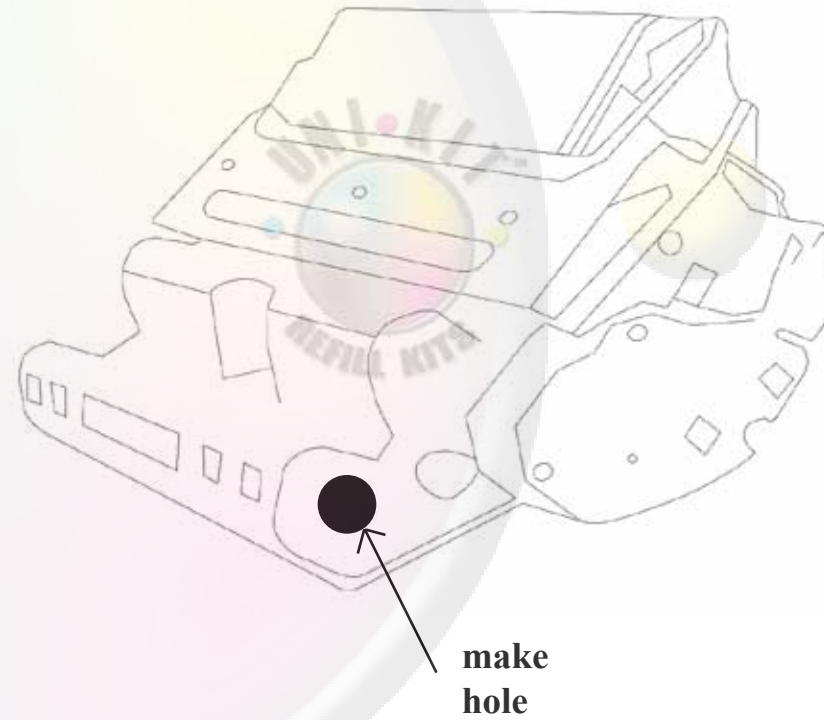



Please be advised that some toner refill kits may be compatible with multiple toner cartridges.



[CLICK HERE TO GO THE INDEX](#)

HP - C3900A  
Canon – EPB  
Xerox - 6R907  
Minolta- 1710081001  
Lexmark - 140100A

#### REQUIRED FOR A SUCCESSFUL REFILL:

- Toner
- 1 funnel cap
- 1 hole plug
- Toner Hole Making Tool

#### General Refilling Procedures:

Rest the Hole Making Tool on its stand and plug into an outlet. Wait 3 full minutes before using. Position the copper bit on the cartridge in the spot indicated by the photograph and push gently until it melts a hole in the cartridge. Remove the tool, place it back on its stand and unplug it. If the small piece of plastic has fallen into the cartridge, it must be removed, as this can damage your cartridge or cause print defects. If the piece remains in the tool, wait for the tool to cool down and pry it out.

Before opening the bottle of toner, turn it upside down and tap it on a table to loosen the toner and allow it to flow freely. Remove the cap and pull the seal off the bottle. Attach the funnel cap making to sure it is on tightly. Tilt the funnel cap toward the filling hole and insert it into the hole. If the toner stops flowing before the cartridge is full, simply remove the toner, close the cap, turn the bottle upside down and tap it on a table. Once the cartridge is full seal the hole with the plug.

We do NOT recommend using the plug provided in the kit to seal the filling hole. Instead use duct tape. There is an auger inside the which needs to rotate freely in order to distribute the toner evenly. Now gently shake the cartridge side to side to distribute the toner.

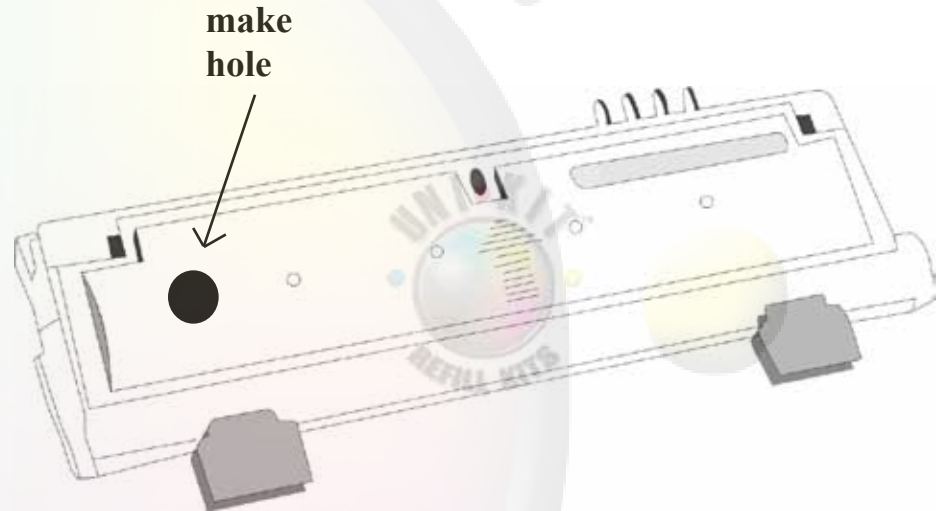

Please be advised that some toner refill kits may be compatible with multiple toner cartridges.



Pitney Bowes - 8060  
HP- 92275A  
DEC - LN07XAA  
Canon - FX1/EPL  
Apple - M0089

[CLICK HERE TO GO THE INDEX](#)

### REQUIRED FOR A SUCCESSFUL REFILL:

- Toner
- 1 funnel cap
- 1 hole plug
- Toner Hole Making Tool

### General Refilling Procedures:

Rest the Hole Making Tool on its stand and plug into an outlet. Wait 3 full minutes before using. Position the copper bit on the cartridge in the spot indicated by the photograph and push gently until it melts a hole in the cartridge. It is critical that the hole is butting up against the horizontal edge of the hopper.

Remove the tool, place it back on its stand and unplug it. If the small piece of plastic has fallen into the cartridge, it must be removed, as this can damage your cartridge or cause print defects. If the piece remains in the tool, wait for the tool to cool down and pry it out.

Before opening the bottle of toner, turn it upside down and tap it on a table to loosen the toner and allow it to flow freely. Remove the cap and pull the seal off the bottle. Attach the funnel cap making to sure it is on tightly. Tilt the funnel cap toward the filling hole and insert it into the hole. If the toner stops flowing before the cartridge is full, simply remove the toner, close the cap, turn the bottle upside down and tap it on a table. Once the cartridge is full seal the hole with the plug.

We do NOT recommend using the plug provided in the kit to seal the filling hole. Instead use duct tape. There is an auger inside the which needs to rotate freely in order to distribute the toner evenly. Now gently shake the cartridge side to side to distribute the toner.



make  
hole

Please be advised that some toner refill kits may be compatible with multiple toner cartridges.



[CLICK HERE TO GO THE INDEX](#)

Ricoh - 339302  
Minolta - 17030190000  
Lexmark - 140195AX  
HP - 92295AX  
Canon - XS/EPS  
Apple-M6002

#### REQUIRED FOR A SUCCESSFUL REFILL:

- Toner
- 1 funnel cap
- 1 hole plug
- Toner Hole Making Tool

#### *General Refilling Procedures:*

Rest the Hole Making Tool on its stand and plug into an outlet. Wait 3 full minutes before using. Position the copper bit on the cartridge in the spot indicated by the photograph and push gently until it melts a hole in the cartridge. Please note that you will also be putting a hole not only in the cover but the internal cover as well. Remove the tool, place it back on its stand and unplug it. If the small piece of plastic has fallen into the cartridge, it must be removed, as this can damage your cartridge or cause print defects. If the piece remains in the tool, wait for the tool to cool down and pry it out.

Before opening the bottle of toner, turn it upside down and tap it on a table to loosen the toner and allow it to flow freely. Remove the cap and pull the seal off the bottle. Attach the funnel cap making to sure it is on tightly. Tilt the funnel cap toward the filling hole and insert it into the hole. If the toner stops flowing before the cartridge is full, simply remove the toner, close the cap, turn the bottle upside down and tap it on a table. Once the cartridge is full seal the hole with the plug.

Do not press down on the plug since the cartridge is resting on a table this can actually damage the photo-optic drum. Instead hold one end of the cartridge up off the table and twist the plug until it fully sealed. Now gently shake the cartridge side to side to distribute the toner.



Please be advised that some toner refill kits may be compatible with multiple toner cartridges.



Minolta -17030210000  
HP - 92285A  
Canon – EPC/A20  
Apple - M0180

[CLICK HERE TO GO THE INDEX](#)

#### REQUIRED FOR A SUCCESSFUL REFILL:

- Toner
- 1 funnel cap
- 1 hole plug
- Toner Hole Making Tool

#### *General Refilling Procedures:*

Rest the Hole Making Tool on its stand and plug into an outlet. Wait 3 full minutes before using. Use a Flathead screwdriver to remove the cardboard cover over the toner hopper. Position the copper bit on the cartridge in the spot indicated by the photograph and push gently until it melts a hole in the cartridge. Make sure to keep the hole on the flat surface of the cartridge and not on the curved edge. Remove the tool, place it back on its stand and unplug it. If the small piece of plastic has fallen into the cartridge, it must be removed, as this can damage your cartridge or cause print defects. If the piece remains in the tool, wait for the tool to cool down and pry it out.

Before opening the bottle of toner, turn it upside down and tap it on a table to loosen the toner and allow it to flow freely. Remove the cap and pull the seal off the bottle. Attach the funnel cap making to sure it is on tightly. Tilt the funnel cap toward the filling hole and insert it into the hole. If the toner stops flowing before the cartridge is full, simply remove the toner, close the cap, turn the bottle upside down and tap it on a table. Once the cartridge is full seal the hole with the plug.

Do not press down on the plug since the cartridge is resting on a table this can actually damage the photo-optic drum. Instead hold one end of the cartridge up off the table and twist the plug until it fully sealed. Now gently shake the cartridge side to side to distribute the toner.

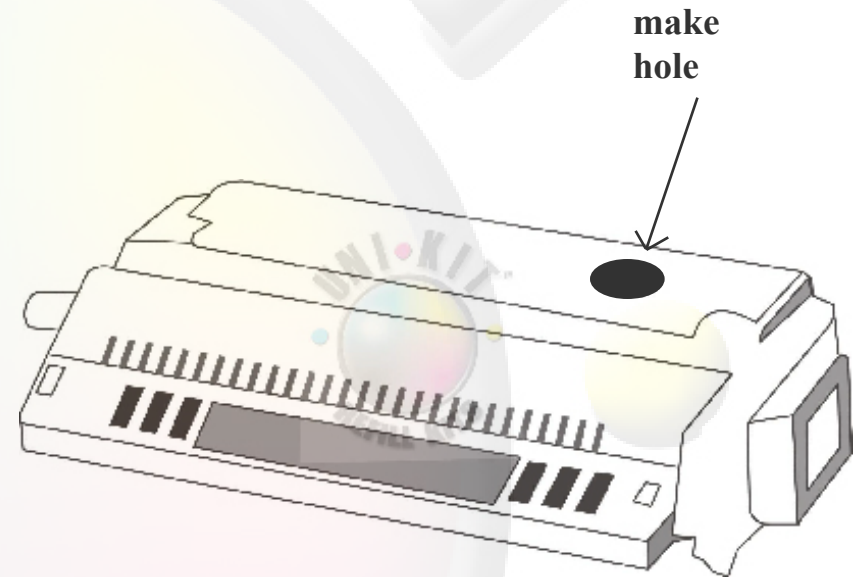



Please be advised that some toner refill kits may be compatible with multiple toner cartridges.



HP – C8061A

[CLICK HERE TO GO THE INDEX](#)

#### REQUIRED FOR A SUCCESSFUL REFILL:

- Toner
- 1 funnel cap
- 1 hole plug
- Toner Hole Making Tool

#### General Refilling Procedures:

Rest the Hole Making Tool on its stand and plug into an outlet. Wait 3 full minutes before using. Position the copper bit on the cartridge in the spot indicated by the photograph and push gently until it melts a hole in the cartridge. Make sure to keep the hole on the flat surface of the cartridge and not on the curved edge. Remove the tool, place it back on its stand and unplug it. If the small piece of plastic has fallen into the cartridge, it must be removed, as this can damage your cartridge or cause print defects. If the piece remains in the tool, wait for the tool to cool down and pry it out.

Before opening the bottle of toner, turn it upside down and tap it on a table to loosen the toner and allow it to flow freely. Remove the cap and pull the seal off the bottle. Attach the funnel cap making to sure it is on tightly. Tilt the funnel cap toward the filling hole and insert it into the hole. If the toner stops flowing before the cartridge is full, simply remove the toner, close the cap, turn the bottle upside down and tap it on a table. Once the cartridge is full seal the hole with the plug.

Do not press down on the plug since the cartridge is resting on a table this can actually damage the photo-optic drum. Instead hold one end of the cartridge up off the table and twist the plug until it fully sealed. Now gently shake the cartridge side to side to distribute the toner.

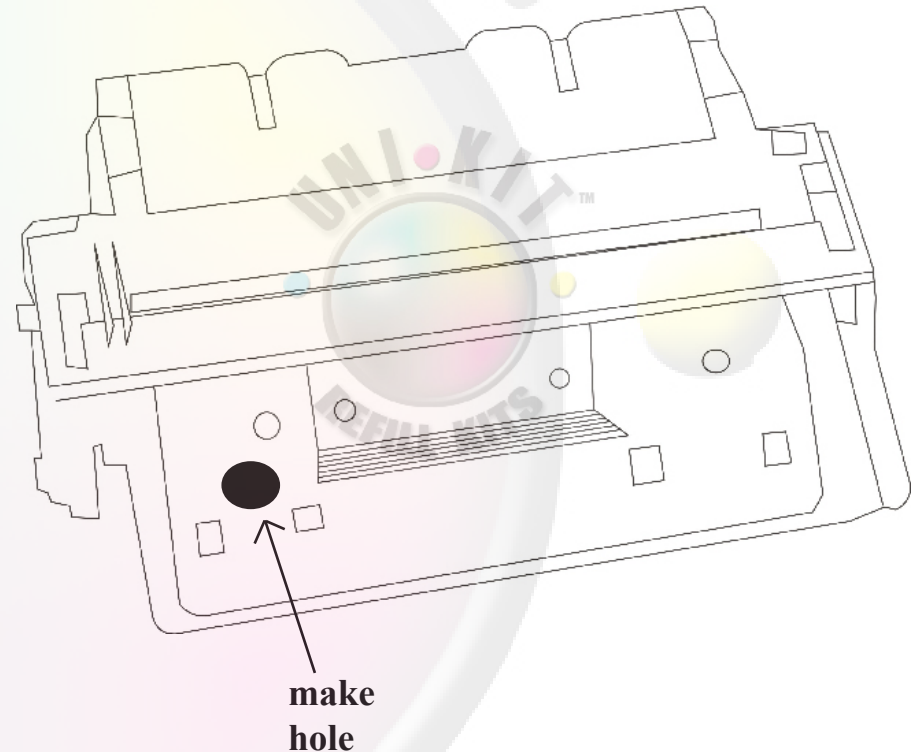

Please be advised that some toner refill kits may be compatible with multiple toner cartridges.



HP 1500 / HP 2500 / HP 2550 / HP 2800 / HP 2840 / HP 2850

[CLICK HERE TO GO THE INDEX](#)

1. Remove three screws on the side opposite the gears.



2. Remove the end plate on the side.

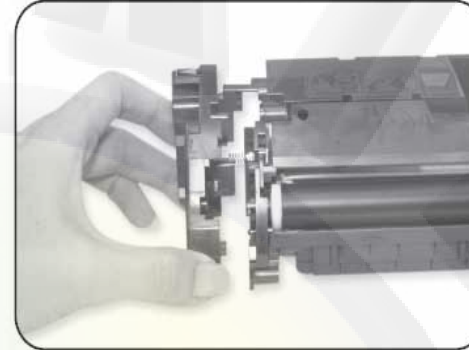

3. Remove one more screw.



4. DO NOT lose the round bearing part.



5. Remove the plastic cap to expose the filling hole.

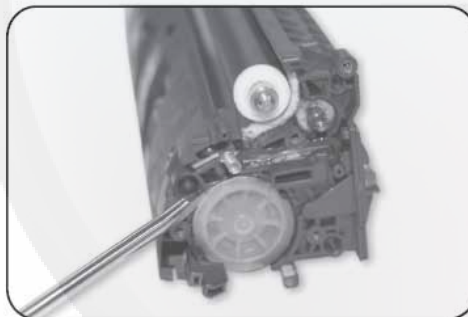

6. Dump out any excess toner, and pour new toner in. It is always better to underfill than to overfill a cartridge.



#### GENERAL COMMENTS:

HP 1500 / 2500 / 2550 cartridges require smart chips to be replaced in order for the printer to recognize the refilled cartridge as “new”. You should replace the smart chip only AFTER you refill the cartridge. DO NOT remove the chip after you have installed it.

© All rights reserved, Easy Group, LLC. Version 6.0

All trademarks are property of their respective owners. Uni-Kit® has no association with any of the manufacturers listed here such as Hp, Epson, Lexmark, Xerox, etc. All logos and brand names shown here are used for identification purposes only. It is illegal to reproduce these instructions without written licensing consent from Easy Group LLC.

Please be advised that some toner refill kits may be compatible with multiple toner cartridges.



HP -92274A  
Canon - FX2/EPP  
Apple - M2045GA

[CLICK HERE TO GO THE INDEX](#)

#### REQUIRED FOR A SUCCESSFUL REFILL:

- Toner
- 1 funnel cap
- 1 hole plug
- Toner Hole Making Tool

#### *General Refilling Procedures:*

Rest the Hole Making Tool on its stand and plug into an outlet. Wait 3 full minutes before using. Position the copper bit on the cartridge in the spot indicated by the photograph and push gently until it melts a hole in the cartridge. Make sure to keep the hole on the flat surface of the cartridge and not on the curved edge. Remove the tool, place it back on its stand and unplug it. If the small piece of plastic has fallen into the cartridge, it must be removed, as this can damage your cartridge or cause print defects. If the piece remains in the tool, wait for the tool to cool down and pry it out.

Before opening the bottle of toner, turn it upside down and tap it on a table to loosen the toner and allow it to flow freely. Remove the cap and pull the seal off the bottle. Attach the funnel cap making to sure it is on tightly. Tilt the funnel cap toward the filling hole and insert it into the hole. If the toner stops flowing before the cartridge is full, simply remove the toner, close the cap, turn the bottle upside down and tap it on a table. Once the cartridge is full seal the hole with the plug.

Do not press down on the plug since the cartridge is resting on a table this can actually damage the photo-optic drum. Instead hold one end of the cartridge up off the table and twist the plug until it fully sealed. Now gently shake the cartridge side to side to distribute the toner.

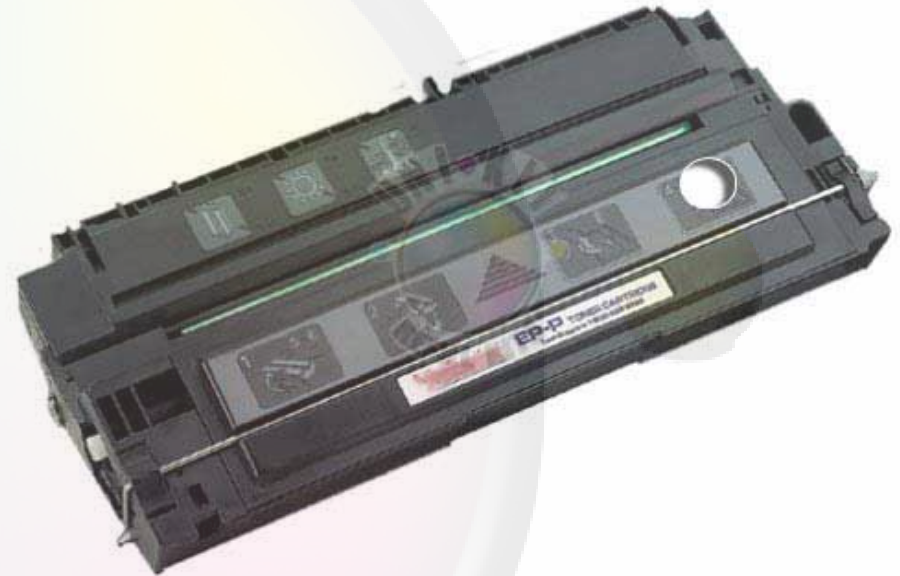



Please be advised that some toner refill kits may be compatible with multiple toner cartridges.



### HP 1600/2600 Color Laserjet

[CLICK HERE TO GO THE INDEX](#)

The first step in refilling your color laserjet HP 2600 cartridges is to EMPTY THE WASTE HOPPER. This is an essential step because waste toner has accumulated in the hopper (which is like a waste collection space). You can empty the waste hopper by using the hole making tool to make a hole at the location shown in the diagram. The tool needs to be plugged in to an electrical outlet, wait 1-3 minutes for the tool to heat up (be careful - it gets HOT!) and then gently push the tip of the tool against the cartridge in the location shown until it makes a nice round hole. You need to remove the round plastic piece that is burnt out by the tool. Now slowly turn the cartridge upside down over a trash collection bag so that the waste toner can empty out.

When empty, you can seal this hole using electrical tape.



Make a 2nd hole in the cartridge at the location shown in this diagram. Make sure you remove the round plastic piece that you burn out. **IMPORTANT:** Just like with the waste hopper, you need to EMPTY OUT any remaining original toner from the cartridge. Our toner may not work as well if it is mixed with the original toner. If there is slight mixing that is OK, just as long as most of the original toner is gone.

Attach the pouring spout to the toner bottle and fill the cartridge. Seal the filling hole again with electrical tape. **IMPORTANT:** Do NOT try sealing the hole with a plug as there is a blade on the inside of the cartridge that rotates and needs to be able to rotate almost flush with the cartridge shell, so nothing should protrude into the cartridge.



The chip needs to be replaced. This is a lockout chip, which means that unless you replace the chip the printer will not recognize the refilled cartridge (it will remember it as empty and prevent you from printing). In order to remove the original chip, you need to make 2 small cuts in the plastic at the 2 points on top of the chip that (see diagram). This will allow the chip to be pushed up and out by using a thin flat object such as a flat screwdriver.

Replace the old chip with a new replacement chip, and add a touch of glue to the top tips of the chip so that it sits firmly in place against the cartridge.





Please be advised that some toner refill kits may be compatible with multiple toner cartridges.



HP 3500 / 3800 / 4500 / 4600 / 5500

[CLICK HERE TO GO THE INDEX](#)

HP 3500

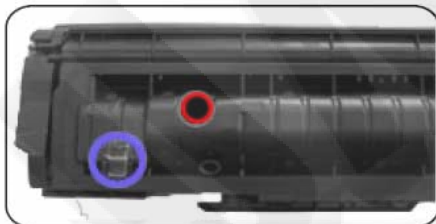

1. Choose a safe surface, such as a work bench, and place the hole making tool to rest on its stand.
2. Plug the tool into a standard wall power outlet and wait for the tool to heat up. Be extremely careful, the tool gets VERY HOT very quickly and can burn you
3. After about 3-4 minutes, the tool is ready for use.

ALWAYS refill in an area where you can tolerate a spill, like a workbench or outside.

HP 4500



1. Using the hole making tool, CAREFULLY burn a hole into the cartridge in the area shown by the red circle BE VERY CAUTIOUS not to burn your self as the tool remains very HOT (see hole position in HP 3500, 4500, 4600).

NOTE: Making a hole in the cartridge leaves you with the burnt out round piece of plastic. If this falls in to the cartridge, you need to remove it by turning the cartridge upside down.

2. EMPTY OUT OLD TONER COMPLETELY.
3. Now you can fill the cartridge with toner by pouring it in, using the toner bottle and nozzle cap so as to avoid spillage.
4. After the cartridge is filled, you need to seal the hole using a plastic plug for the 4500 or duct tape for the 3500 and 4600, making sure that you have a tight seal.
5. Make sure that the transparent sensor (shown by the blue circle) is completely clean. If it is not, the printer may not recognize the cartridge.

HP 4600

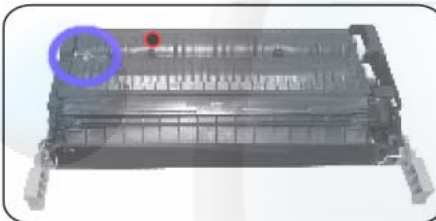

#### GENERAL COMMENTS:

The HP 4600 cartridges have “chips” that recognize the levels in the cartridge. If your cartridge does not print after you have refilled it, then these chips need to be overrid or replaced. We offer 2 procedure to override the chip ink level. If both dont work, replacement chips can be bought on request.

**OVERRIDE PROCEDURE 1:** You just switch off and on the machine. Do it when you take out the cartridge, and after inserting it again.

The chip does not work with physical contact with the drum, but with a radio frequency. In some cases, due to this, you will have to switch off and on more than once, this is the only thing that needs to be done for the machine to recognize the cartridge.

**OVERRIDE PROCEDURE 2:**

Click on “Menu”

Click on “Diagnostics”

Click on “Disable Diagnostics”

#### HP 3500 / 4500 / 4600 / 5500 CHIP REPLACEMENT INSTRUCTIONS



Replace the chip AFTER you have refilled the cartridge

1. Using a soft cloth, wipe the area under the chip clean.

2 Glue / Stick your Replacement chip in the area indicated.



Please be advised that some toner refill kits may be compatible with multiple toner cartridges.

HP 8500

[CLICK HERE TO GO THE INDEX](#)

ALWAYS refill in an area where you can tolerate a spill, like a workbench or outside.

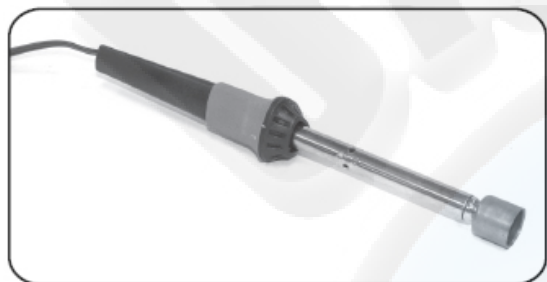

1. Choose a safe surface, such as a work bench, and place hole making tool to rest on its stand.
2. Plug the tool into a standard wall power outlet and wait for the tool to heat up (be extremely careful, the tool gets VERY HOT very quickly and can burn you.)

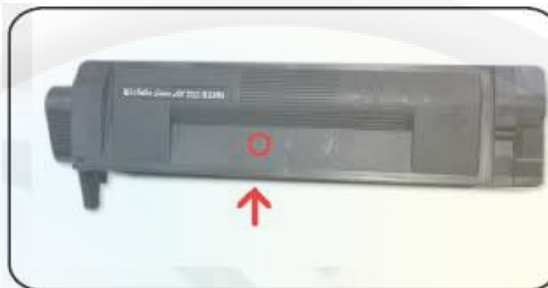

1. Using the hole making tool, CAREFULLY burn a hole into the cartridge in the area shown by the arrow. BE VERY CAREFUL not to burn yourself - the tool remains extremely HOT.

**NOTE:** Marking a hole in the cartridge leaves you with the burnt out round piece of plastic. If this falls into the cartridge, you need to remove it by turning the cartridge upside down.



2. Now you can fill the cartridge with toner by pouring it in, using the toner bottle and nozzle cap so as to avoid spillage.
3. After the cartridge is filled, you need to seal the hole using a plastic plug.

#### GENERAL COMMENTS:

It is always better to underfill than to overfill a cartridge. You can always add more toner later. Uni-Kit toner is researched and tested to produce excellent results - your first refill should be nearly 100% same quality as the original cartridge. It is recommended that you refill the same cartridge no more than 2-3 times, because with each print cycle the cartridge will wear and tear and quality will slowly diminish.

Please be advised that some toner refill kits may be compatible with multiple toner cartridges.



## HP 8500 Drum Chip Replacement

[CLICK HERE TO GO THE INDEX](#)

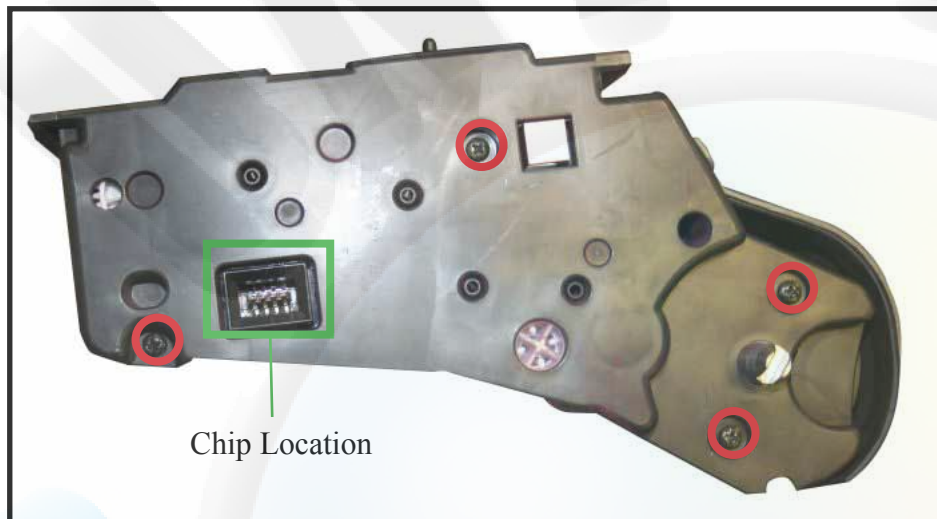

### Step 1.

To replace the chip on the HP 8500 Drum, simply remove one of the end caps of the cartridge. The picture on the right shows 4 screws (circled in red) that must be removed in order to fully remove the end cap that the chip is located on.

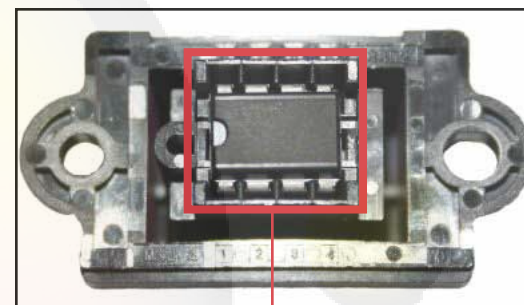

Chip

### Step 2.

Once you have successfully removed the end cap, you will need to remove the chip compartment. The chip compartment is held down by 2 screws. Remove these screws to free the compartment.

### Step 3.

Once you have removed the chip compartment, the backside of the compartment should look similar to the picture above. As you can see, the chip is located at the center of this compartment. Using a thin Flathead screwdriver, loosen the chip, then completely remove it. You may now replace it with the Uni-kit chip you received and reassemble everything by reversing the steps.





Please be advised that some toner refill kits may be compatible with multiple toner cartridges.



HP Color Laserjet 9500 / Canon ImageRunner 3200

[CLICK HERE TO GO THE INDEX](#)

#### REQUIRED FOR A SUCCESSFUL REFILL:

- Toner
- 1 funnel cap
- 1 hole plug
- Toner Hole Making Tool

A



B



Refill hole

#### General Refilling Procedures:

Rest the Hole Making Tool on its stand and plug into an outlet. Wait 3 full minutes before using. Position the copper bit on the cartridge in the spot indicated by the photograph and push gently until it melts a hole in the cartridge. Remove the tool, place it back on its stand and unplug it. If the small piece of plastic has fallen into the cartridge, it must be removed, as this can damage your cartridge or cause print defects. If the piece remains in the tool, wait for the tool to cool down and pry it out.

Before opening the bottle of toner, turn it upside down and tap it on a table to loosen the toner and allow it to flow freely. Remove the cap and pull the seal off the bottle. Attach the funnel cap making to sure it is on tightly. Tilt the funnel cap toward the filling hole and insert it into the hole. If the toner stops flowing before the cartridge is full, simply remove the toner, close the cap, turn the bottle upside down and tap it on a table. Once the cartridge is full seal the hole with the plug. Now gently shake the cartridge side to side to distribute the toner.

ALWAYS refill in an area where you can tolerate a spill, like a workbench or outside.

#### CHIP REMOVAL & INSTALLATION



1. Using a small flat blade screwdriver, carefully pry the chip forward by inserting the blade in the notch and remove the chip.
2. Use your fingers to peel away any remaining adhesive residue to ensure a clean surface. Use a dry, lint-free cloth and 91%-99% isopropyl alcohol to clean any residual adhesive from the mounting surface
3. Peel off the adhesive backing from a new chip and place the chip on the cartridge, making the angled area on the chip is aligned with the angled area on the cartridge .

© All rights reserved, Easy Group, LLC. Version 6.0

All trademarks are property of their respective owners. Uni-Kit® has no association with any of the manufacturers listed here such as Hp, Epson, Lexmark, Xerox, etc. All logos and brand names shown here are used for identification purposes only. It is illegal to reproduce these instructions without written licensing consent from Easy Group LLC.



Please be advised that some toner refill kits may be compatible with multiple toner cartridges.



HP 7553A/7553X

[CLICK HERE TO GO THE INDEX](#)

#### REQUIRED FOR A SUCCESSFUL REFILL:

- Toner
- 1 funnel cap
- Duct Tape *(Optional)*
- Toner Hole Making Tool
- Requires replacement chip

#### General Refilling Procedures:

Rest the Hole Making Tool on its stand and plug into an outlet. Wait 3 full minutes before using. Position the copper bit on the cartridge in the spot indicated in photograph A and push gently until it melts a hole in the cartridge. Make sure to keep the hole on the flat surface of the cartridge and not on the curved edge. Remove the tool, place it back on its stand and unplug it. If the small piece of plastic has fallen into the cartridge, it must be removed, as this can damage your cartridge or cause print defects. If the piece remains in the tool, wait for the tool to cool down and pry it out.

Before opening the bottle of toner, turn it upside down and tap it on a table to loosen the toner and allow it to flow freely. Remove the cap and pull the seal off the bottle. Attach the funnel cap making to sure it is on tightly. Tilt the funnel cap toward the filling hole and insert it into the hole. If the toner stops flowing before the cartridge is full, simply remove the toner, close the cap, turn the bottle upside down and tap it on a table. Once the cartridge is full, clean any excess toner around the hole and seal it with duct tape.

Now gently shake the cartridge side to side to distribute the toner.

### C7553X

Top View



Create Refilling hole here

### C7553A

Top View



Bottom View

Create Refilling hole here



Please be advised that some toner refill kits may be compatible with multiple toner cartridges.



HP 7551A/7551X

[CLICK HERE TO GO THE INDEX](#)

### REQUIRED FOR A SUCCESSFUL REFILL:

- Toner
- 1 funnel cap
- 1 hole plug
- Toner Hole Making Tool
- Requires replacement chip

### General Refilling Procedures:

Rest the Hole Making Tool on its stand and plug into an outlet. Wait 3 full minutes before using. Position the copper bit on the cartridge in the spot indicated in photograph A and push gently until it melts a hole in the cartridge. Make sure to keep the hole on the flat surface of the cartridge and not on the curved edge. Remove the tool, place it back on its stand and unplug it. If the small piece of plastic has fallen into the cartridge, it must be removed, as this can damage your cartridge or cause print defects. If the piece remains in the tool, wait for the tool to cool down and pry it out.

Before opening the bottle of toner, turn it upside down and tap it on a table to loosen the toner and allow it to flow freely. Remove the cap and pull the seal off the bottle. Attach the funnel cap making to sure it is on tightly. Tilt the funnel cap toward the filling hole and insert it into the hole. If the toner stops flowing before the cartridge is full, simply remove the toner, close the cap, turn the bottle upside down and tap it on a table. Once the cartridge is full seal the hole with the plug.

Do not press down on the plug since the cartridge is resting on a table this can actually damage the photo-optic drum. Instead hold one end of the cartridge up off the table and twist the plug until it fully sealed. Now gently shake the cartridge side to side to distribute the toner.

A.



Create hole for  
refill here

Please be advised that some toner refill kits may be compatible with multiple toner cartridges.



HP 3600/3800/4700

[CLICK HERE TO GO THE INDEX](#)

HP 3600/3800

#### REQUIRED FOR A SUCCESSFUL REFILL:

- Toner
- Plug or duct tape (duct tape recommended)
- 1 hole making tool

Note: Please read carefully before refilling cartridge.

#### General Refilling Procedures:

Make sure you lay the cartridge down so that it looks like the illustrations to the right. Plug in your hole making tool for 5 min so that it may warm up and be ready for use. Please be very careful with this tool, it can get very hot and cause serious burns. Once your hole making tool is ready for use, make a hole on the cartridge as shown in the illustrations to the right (The white circles on each illustration show where the hole should be created).

Once the hole has been created, empty any toner left inside the cartridge (mixing two different brands of toners could result in bad printing, or rare discoloration in your prints).

Before opening the bottle of toner, turn it upside down and tap it on a table to loosen the toner and allow it to flow freely. Remove the cap and pull the seal off the bottle. Attach the funnel cap making sure it is on tightly. Tilt the cartridge at a 45 degree angle and then the funnel cap toward the filling hole and insert it into the hole. If the toner stops flowing before the cartridge is full, simply remove the toner, close the cap, turn the bottle upside down and tap it on a table. Once you are done refilling this cartridge, use duct tape or electrical tape to seal up the hole by taping over it.

Replace the chip(s) on each cartridge that has been refilled. A small modification may need to be made to the top melted sides that hold the chip in place. You may cut those edges off to release the chip from its holder and slide the

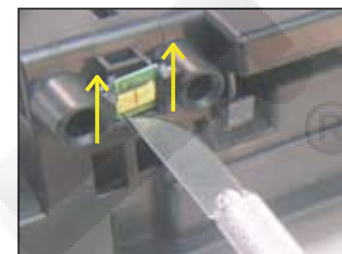

Remove old chip



Install new chip

HP 4700





Please be advised that some toner refill kits may be compatible with multiple toner cartridges.



HP C4129X

[CLICK HERE TO GO THE INDEX](#)

#### REQUIRED FOR A SUCCESSFUL REFILL:

- Toner
- 1 funnel cap
- 1 hole plug (Optional - Electrical Tape/Duct Tape)
- Toner Hole Making Tool

#### General Refilling Procedures:

Rest the Hole Making Tool on its stand and plug into an outlet. Wait 3 full minutes before using. Position the copper bit on the cartridge in the spot indicated in photograph A and push gently until it melts a hole in the cartridge. Make sure to keep the hole on the flat surface of the cartridge and not on the curved edge. Remove the tool, place it back on its stand and unplug it. If the small piece of plastic has fallen into the cartridge, it must be removed, as this can damage your cartridge or cause print defects. If the piece remains in the tool, wait for the tool to cool down and pry it out.

**IMPORTANT:** You must dispose of any original toner in the cartridge as much as possible before refilling. Dispose of toner properly into a trash can, or use a vacuum with a hose for best results (if possible).

Before opening the bottle of toner, turn it upside down and tap it on a table to loosen the toner and allow it to flow freely. Remove the cap and pull the seal off the bottle. Attach the funnel cap making sure it is on tightly. Tilt the funnel cap toward the filling hole and insert it into the hole. If the toner stops flowing before the cartridge is full, simply remove the toner, close the cap, turn the bottle upside down and tap it on a table. Once the cartridge is full seal the hole with the plug.

Do not press down on the plug since the cartridge is resting on a table this can actually damage the photo-optic drum. Instead hold one end of the cartridge up off the table and twist the plug until it fully sealed. Now gently shake the cartridge side to side to distribute the toner.

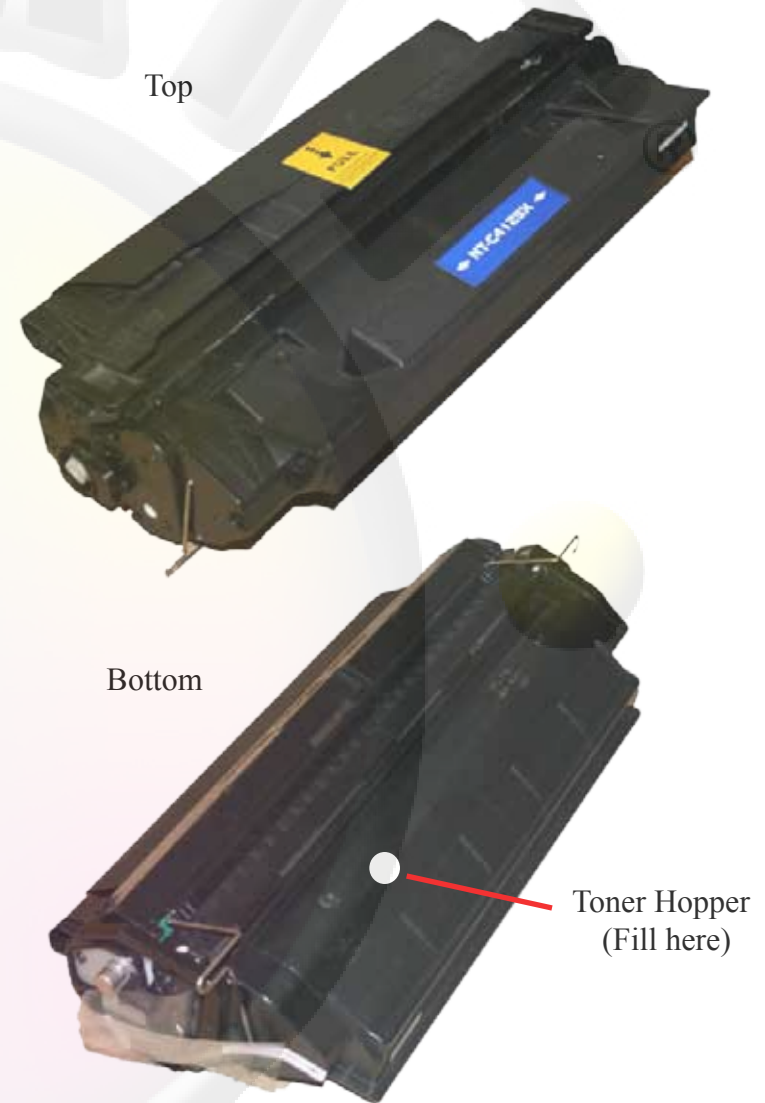



Please be advised that some toner refill kits may be compatible with multiple toner cartridges.



HP 8543X

[CLICK HERE TO GO THE INDEX](#)

#### REQUIRED FOR A SUCCESSFUL REFILL:

- Toner
- 1 funnel cap
- 1 hole plug
- Toner Hole Making Tool
- Flat Head Screw Driver

#### General Refilling Procedures:

Rest the Hole Making Tool on its stand and plug into an outlet. Wait 3 full minutes before using. Position the copper bit on the cartridge in the spot indicated in photograph A and push gently until it melts a hole in the cartridge. Make sure to keep the hole on the flat surface of the cartridge and not on the curved edge. Remove the tool, place it back on its stand and unplug it. If the small piece of plastic has fallen into the cartridge, it must be removed, as this can damage your cartridge or cause print defects. If the piece remains in the tool, wait for the tool to cool down and pry it out.

**IMPORTANT:** You must dispose of any original toner in the cartridge as much as possible before refilling. Dispose of toner properly into a trash can, or use a vacuum with a hose for best results (if possible).

Before opening the bottle of toner, turn it upside down and tap it on a table to loosen the toner and allow it to flow freely. Remove the cap and pull the seal off the bottle. Attach the funnel cap making sure it is on tightly. Tilt the funnel cap toward the filling hole and insert it into the hole. If the toner stops flowing before the cartridge is full, simply remove the toner, close the cap, turn the bottle upside down and tap it on a table. Once the cartridge is full seal the hole with the plug or electrical tape (duct tape will work fine as well). Now gently shake the cartridge side to side to distribute the toner.

With a flat head screw driver, gently pry the OEM chip from its holding. Replace it with the new Uni-Kit chip. Your cartridge is now ready for use.

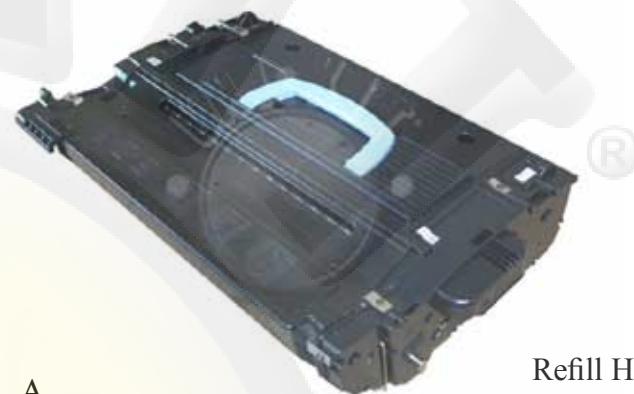

A.

Refill Hole

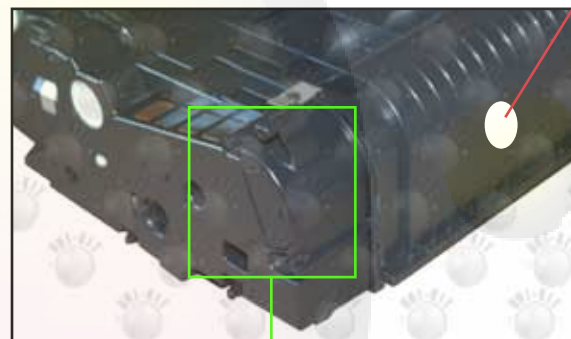

B.



Chip

Please be advised that some toner refill kits may be compatible with multiple toner cartridges.



HP C3909A

[CLICK HERE TO GO THE INDEX](#)

#### REQUIRED FOR A SUCCESSFUL REFILL:

- Toner
- 1 funnel cap
- 1 hole plug (Optional - Electrical Tape/Duct Tape)
- Toner Hole Making Tool

#### General Refilling Procedures:

Rest the Hole Making Tool on its stand and plug into an outlet. Wait 3 full minutes before using. Position the copper bit on the cartridge in the spot indicated in photograph A and push gently until it melts a hole in the cartridge. Make sure to keep the hole on the flat surface of the cartridge and not on the curved edge. Remove the tool, place it back on its stand and unplug it. If the small piece of plastic has fallen into the cartridge, it must be removed, as this can damage your cartridge or cause print defects. If the piece remains in the tool, wait for the tool to cool down and pry it out.

**IMPORTANT:** You must dispose of any original toner in the cartridge as much as possible before refilling. Dispose of toner properly into a trash can, or use a vacuum with a hose for best results (if possible). Do not overfill the cartridge by pouring the entire toner powder into the cartridge. Use half the bottle now, and the rest at a later time. Overfilling can and will damage a cartridge.

Before opening the bottle of toner, turn it upside down and tap it on a table to loosen the toner and allow it to flow freely. Remove the cap and pull the seal off the bottle. Attach the funnel cap making to sure it is on tightly. Tilt the funnel cap toward the filling hole and insert it into the hole. If the toner stops flowing before the cartridge is full, simply remove the toner, close the cap, turn the bottle upside down and tap it on a table. Once the cartridge is full seal the hole with the plug.

Do not press down on the plug since the cartridge is resting on a table this can actually damage the photo-optic drum. Instead hold one end of the cartridge up off the table and twist the plug until it fully sealed. Now gently shake the cartridge side to side to distribute the toner.



Please be advised that some toner refill kits may be compatible with multiple toner cartridges.



HP CB435A

[CLICK HERE TO GO THE INDEX](#)

#### REQUIRED FOR A SUCCESSFUL REFILL:

- Toner
- 1 funnel cap
- 1 hole plug (Optional - Electrical Tape/Duct Tape)
- Toner Hole Making Tool

#### General Refilling Procedures:

Rest the Hole Making Tool on its stand and plug into an outlet. Wait 3 full minutes before using. Position the copper bit on the cartridge in the spot indicated in photograph A and push gently until it melts a hole in the cartridge. Make sure to keep the hole on the flat surface of the cartridge and not on the curved edge. Remove the tool, place it back on its stand and unplug it. If the small piece of plastic has fallen into the cartridge, it must be removed, as this can damage your cartridge or cause print defects. If the piece remains in the tool, wait for the tool to cool down and pry it out.

**IMPORTANT:** You must dispose of any original toner in the cartridge as much as possible before refilling. Dispose of toner properly into a trash can, or use a vacuum with a hose for best results (if possible).

Before opening the bottle of toner, turn it upside down and tap it on a table to loosen the toner and allow it to flow freely. Remove the cap and pull the seal off the bottle. Attach the funnel cap making sure it is on tightly. Tilt the funnel cap toward the filling hole and insert it into the hole. If the toner stops flowing before the cartridge is full, simply remove the toner, close the cap, turn the bottle upside down and tap it on a table. Once the cartridge is full seal the hole with the plug.

Do not press down on the plug since the cartridge is resting on a table this can actually damage the photo-optic drum. Instead hold one end of the cartridge up off the table and twist the plug until it fully sealed. Now gently shake the cartridge side to side to distribute the toner.



Create Refill Hole Here

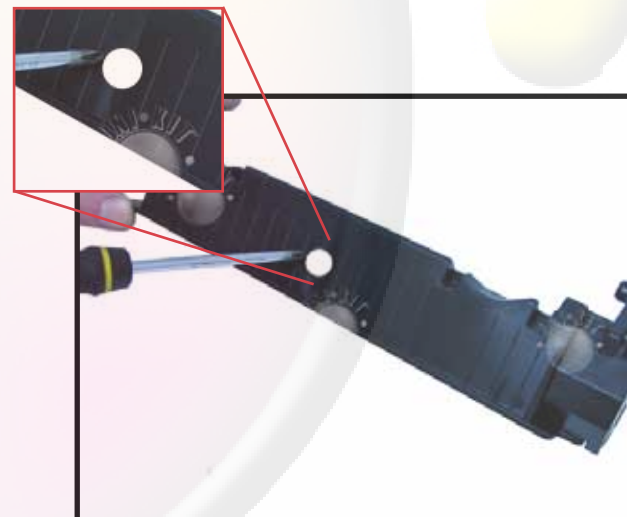



Please be advised that some toner refill kits may be compatible with multiple toner cartridges.



HP 5942

[CLICK HERE TO GO THE INDEX](#)

#### REQUIRED FOR A SUCCESSFUL REFILL:

- Toner
- 1 funnel cap
- 1 hole plug (Optional - Electrical Tape/Duct Tape)
- Toner Hole Making Tool

#### General Refilling Procedures:

Rest the Hole Making Tool on its stand and plug into an outlet. Wait 3 full minutes before using. Position the copper bit on the cartridge in the spot indicated in photograph A and push gently until it melts a hole in the cartridge. Make sure to keep the hole on the flat surface of the cartridge and not on the curved edge. Remove the tool, place it back on its stand and unplug it. If the small piece of plastic has fallen into the cartridge, it must be removed, as this can damage your cartridge or cause print defects. If the piece remains in the tool, wait for the tool to cool down and pry it out.

***IMPORTANT: You must dispose of any original toner in the cartridge as much as possible before refilling. Dispose of toner properly into a trash can. Do not overfill the cartridge by pouring the entire toner powder into the cartridge. Use half the bottle now, and the rest at a later time. Overfilling can and will damage a cartridge.***

Before opening the bottle of toner, turn it upside down and tap it on a table to loosen the toner and allow it to flow freely. Remove the cap and pull the seal off the bottle. Attach the funnel cap making sure it is on tightly. Tilt the funnel cap toward the filling hole and insert it into the hole. If the toner stops flowing before the cartridge is full, simply remove the toner, close the cap, turn the bottle upside down and tap it on a table. Once the cartridge is full seal the hole with the plug.

Do not press down on the plug since the cartridge is resting on a table this can actually damage the photo-optic drum. Instead hold one end of the cartridge up off the table and twist the plug until it fully sealed. Now gently shake the cartridge side to side to distribute the toner.

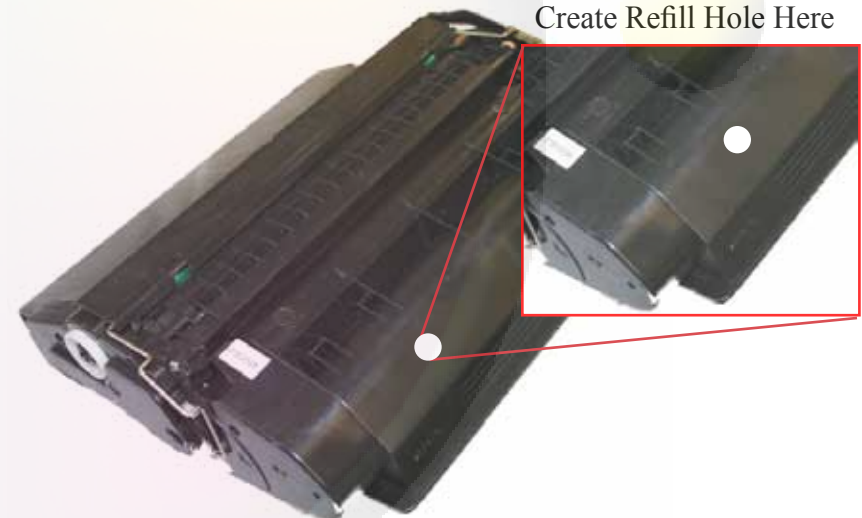



Please be advised that some toner refill kits may be compatible with multiple toner cartridges.



HP CP4005

[CLICK HERE TO GO THE INDEX](#)

#### REQUIRED FOR A SUCCESSFUL REFILL:

- Toner
- 1 hole making tool
- 1 Uni-kit Replacement Chip

Note: Please read carefully before refilling cartridge.

#### General Refilling Procedures:

Make sure you lay the cartridge down so that it looks like the illustrations to the right. Plug in your hole making tool for 5 min so that it may warm up and be ready for use. Please be very careful with this tool, it can get very hot and cause serious burns. Once your hole making tool is ready for use, make a hole on the cartridge as shown in the illustrations to the right (The red circles on each illustration show where the hole should be created).

**IMPORTANT:** You must dispose of any original toner in the cartridge as much as possible before refilling. Dispose of toner properly into a trash can. Do not overfill the cartridge by pouring the entire toner powder into the cartridge. Use half the bottle now, and the rest at a later time. Overfilling can and will damage a cartridge.

Before opening the bottle of toner, turn it upside down and tap it on a table to loosen the toner and allow it to flow freely. Remove the cap and pull the seal off the bottle. Attach the funnel cap making to sure it is on tightly. Tilt the cartridge at a 45 degree angle and then the funnel cap toward the filling hole and insert it into the hole. If the toner stops flowing before the cartridge is full, simply remove the toner, close the cap, turn the bottle upside down and tap it on a table. Once you are done refilling this cartridge, use duct tape or electrical tape to seal up the hole by taping over it.

Replace the chip(s) on each cartridge that has been refilled. Please keep in mind that replacement chips may look different than that of the OEM. Once the chip has been replaced, insert your cartridge back into your printer. Your cartridge is now ready for use.

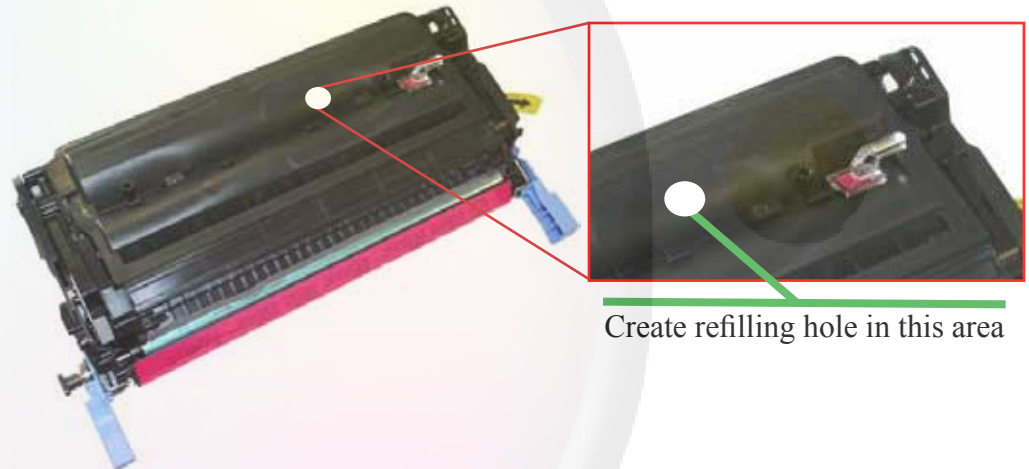

Create refilling hole in this area

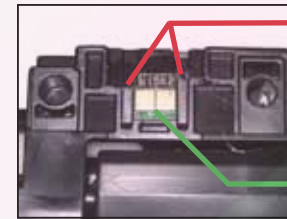

Cut the top sides of the chip holder

Holster chip (Use a little glue at the top edges of the chip to help with the holding)

Please be advised that some toner refill kits may be compatible with multiple toner cartridges.



HP CP1215 / HP CP1518 / CANON 716

[CLICK HERE TO GO THE INDEX](#)

#### REQUIRED FOR A SUCCESSFUL REFILL:

- Toner
- 1 funnel cap
- 1 hole plug (Optional - Electrical Tape/Duct Tape )
- Toner Hole Making Tool

#### General Refilling Procedures:

Rest the Hole Making Tool on its stand and plug into an outlet. Wait 3 full minutes before using. Position the copper bit on the cartridge in the spot indicated in photograph A and push gently until it melts a hole in the cartridge. Be careful not to put too much pressure into the cartridge when creating the hole. Doing so can cause damage to the inside parts of the cartridge if the tool slips and touches any parts inside. Make sure to keep the hole on the flat surface of the cartridge and not on the curved edge. Remove the tool, place it back on its stand and unplug it. If the small piece of plastic has fallen into the cartridge, it must be removed, as this can damage your cartridge or cause print defects. If the piece remains in the tool, wait for the tool to cool down and pry it out.

**IMPORTANT: You must dispose of any original toner in the cartridge as much as possible before refilling. Dispose of toner properly into a trash can. Do not overfill the cartridge by pouring the entire toner powder into the cartridge. Use half the bottle now, and the rest at a later time. Overfilling can and will damage a cartridge.**

Before opening the bottle of toner, turn it upside down and tap it on a table to loosen the toner and allow it to flow freely. Remove the cap and pull the seal off the bottle. Attach the funnel cap making to sure it is on tightly. Tilt the funnel cap toward the filling hole and insert it into the hole. If the toner stops flowing before the cartridge is full, simply remove the toner, close the cap, turn the bottle upside down and tap it on a table. Once the cartridge is full seal the hole with the plug or tape.

Once the cartridge is sealed, rock it back and forth to distribute the toner. Remember to replace the chip (please see pictures B and C below) before inserting the cartridge back into your printer. Once that has been done, your cartridge is ready for use.

A.

Create Refill Hole Here



B.



Remove the chip by cutting the plastic off the edges of both sides of the chip.

C.



Remove and replace the chip. If the new replacement chip is loose in the slot, close off the top edges with small amounts of hot glue.

Please be advised that some toner refill kits may be compatible with multiple toner cartridges.



HP Q6511A/X

[CLICK HERE TO GO THE INDEX](#)

#### REQUIRED FOR A SUCCESSFUL REFILL:

- Toner
- 1 hole making tool
- Duct tape
- 1 replacement chip

Note: Please read carefully before refilling cartridge.

#### General Refilling Procedures:

Make sure you hold this cartridge in an upright position before creating a refill hole (some remaining or excess toner can and may fall out of the cartridge). Illustration A on the right shows you where to create a refill hole for your cartridge. Once the hole has been created, empty any toner left inside the cartridge (*mixing two different brands of toners could result in bad printing, or rare discoloration in your prints*).

**IMPORTANT:** You must dispose of any original toner in the cartridge as much as possible before refilling. Dispose of toner properly into a trash can. Do not overfill the cartridge by pouring the entire toner powder into the cartridge. Use half the bottle now, and the rest at a later time. Overfilling can and will damage a cartridge.

Before opening the bottle of toner, turn it upside down and tap it on a table to loosen the toner and allow it to flow freely. Remove the cap and pull the seal off the bottle. Attach the funnel cap making to sure it is on tightly. Tilt the cartridge at a 45 degree angle and then the funnel cap toward the filling hole and insert it into the hole. If the toner stops flowing before the cartridge is full, simply remove the toner, close the cap, turn the bottle upside down and tap it on a table. When you are done refilling this cartridge, simply use duct tape to seal the refilling hole back.

Next, you will need to replace the chip. Please follow the diagram to the right for chip installation instructions. Once you have finished installing the chip, you may now place your cartridge back into the printer.



Create Refill Hole Here

Strip chip off the cartridge and replace with new chip. Be sure to use gloves and be static free when replacing chips.

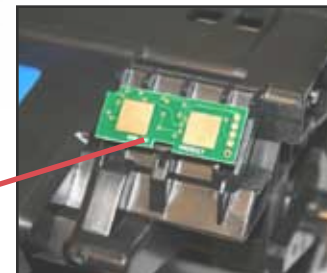



Please be advised that some toner refill kits may be compatible with multiple toner cartridges.



HP 5200, M5025

[CLICK HERE TO GO THE INDEX](#)

#### REQUIRED FOR A SUCCESSFUL REFILL:

- Toner
- 1 hole making tool
- Duct tape
- 1 replacement chip

Note: Please read carefully before refilling cartridge.

#### General Refilling Procedures:

Make sure you hold this cartridge in an upright position before creating a refill hole (some remaining or excess toner can and may fall out of the cartridge). Illustration A on the right shows you where to create a refill hole for your cartridge. Once the hole has been created, empty any toner left inside the cartridge (*mixing two different brands of toners could result in bad printing, or rare discoloration in your prints*).

**IMPORTANT:** You must dispose of any original toner in the cartridge as much as possible before refilling. Dispose of toner properly into a trash can. Do not overfill the cartridge by pouring the entire toner powder into the cartridge. Use half the bottle now, and the rest at a later time. Overfilling can and will damage a cartridge.

Before opening the bottle of toner, turn it upside down and tap it on a table to loosen the toner and allow it to flow freely. Remove the cap and pull the seal off the bottle. Attach the funnel cap making to sure it is on tightly. Tilt the cartridge at a 45 degree angle and then the funnel cap toward the filling hole and insert it into the hole. If the toner stops flowing before the cartridge is full, simply remove the toner, close the cap, turn the bottle upside down and tap it on a table. When you are done refilling this cartridge, simply use duct tape to seal the refilling hole back.

Next, you will need to replace the chip. Please follow the diagram to the right for chip installation instructions. Once you have finished installing the chip, you may now place your cartridge back into the printer.

TOP SIDE



Create Refill Hole Here

#### ~CHIP REPLACEMENT~

In order to replace the chip on this cartridge, the bottom portion of the chip compartment must be clipped off. This allows the chip to be removed and a new one to be inserted.

You can use glue on the edges of the chip once its installed to hold it in place.





Please be advised that some toner refill kits may be compatible with multiple toner cartridges.



HP 2035 / 2055

[CLICK HERE TO GO THE INDEX](#)

#### REQUIRED FOR A SUCCESSFUL REFILL:

- Toner
- 1 hole making tool
- Duct tape (*Not Included*)
- 1 replacement chip

Note: Please read carefully before refilling cartridge.

#### General Refilling Procedures:

Make sure you hold this cartridge in an upright position before creating a refill hole (some remaining or excess toner can and may fall out of the cartridge). Illustration A on the right shows you where to create a refill hole for your cartridge. Once the hole has been created, empty any toner left inside the cartridge (*mixing two different brands of toners could result in bad printing, or rare discoloration in your prints*).

**IMPORTANT:** You must dispose of any original toner in the cartridge as much as possible before refilling. Dispose of toner properly into a trash can. Do not overfill the cartridge by pouring the entire toner powder into the cartridge. Use half the bottle now, and the rest at a later time. Overfilling can and will damage a cartridge.

Before opening the bottle of toner, turn it upside down and tap it on a table to loosen the toner and allow it to flow freely. Remove the cap and pull the seal off the bottle. Attach the funnel cap making to sure it is on tightly. Tilt the cartridge at a 45 degree angle and then the funnel cap toward the filling hole and insert it into the hole. If the toner stops flowing before the cartridge is full, simply remove the toner, close the cap, turn the bottle upside down and tap it on a table. When you are done refilling this cartridge, simply use duct tape to seal the refilling hole back.

Next, you will need to replace the chip. Please follow the diagram to the right for chip installation instructions. Once you have finished installing the chip, you may now place your cartridge back into the printer.

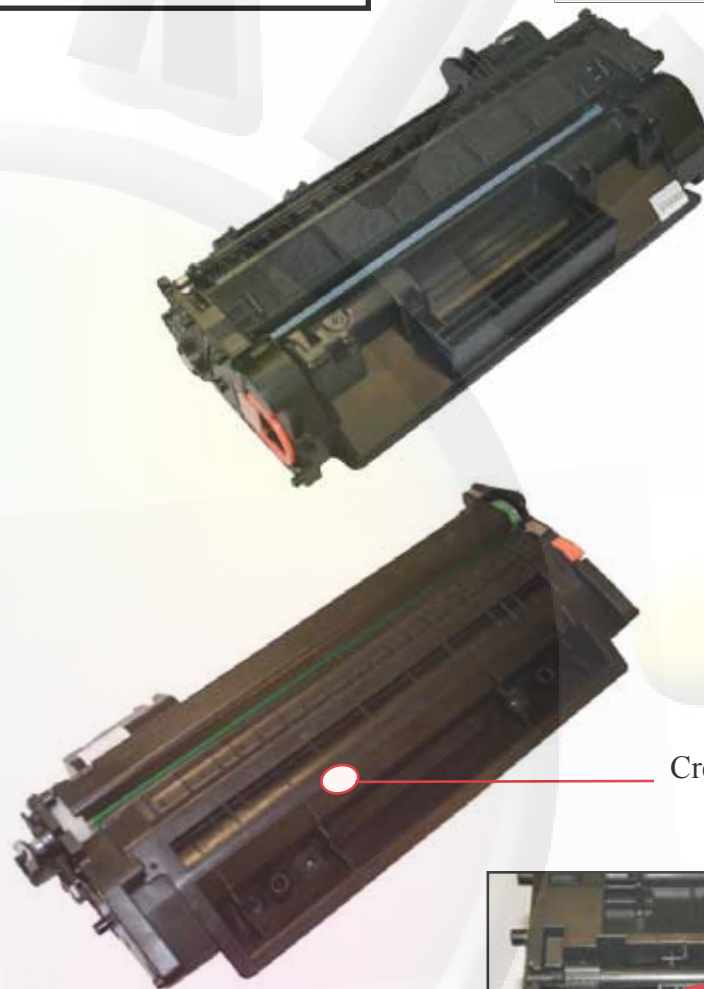

Create Refill Hole Here

Chip holder may need to be moderately modified for chip replacement. Modification includes clipping the top sides of the holder to allow the OEM chip to be removed and the new installed.

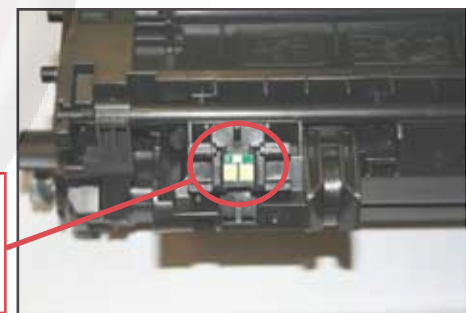

Please be advised that some toner refill kits may be compatible with multiple toner cartridges.



HP CP2025 / CP2020

[CLICK HERE TO GO THE INDEX](#)

#### REQUIRED FOR A SUCCESSFUL REFILL:

- Toner
- 1 funnel cap
- 1 hole plug (Optional)
- Electrical Tape/Duct Tape
- Toner Hole Making Tool

#### General Refilling Procedures:

Rest the Hole Making Tool on its stand and plug into an outlet. Wait 3 full minutes before using. Position the copper bit on the cartridge in the spot indicated in photograph A and push gently until it melts a hole in the cartridge. Be careful not to put too much pressure into the cartridge when creating the hole. Doing so can cause damage to the inside parts of the cartridge if the tool slips and touches any parts inside. Make sure to keep the hole on the flat surface of the cartridge and not on the curved edge. Remove the tool, place it back on its stand and unplug it. If the small piece of plastic has fallen into the cartridge, it must be removed, as this can damage your cartridge or cause print defects. If the piece remains in the tool, wait for the tool to cool down and pry it out.

**IMPORTANT: You must dispose of any original toner in the cartridge as much as possible before refilling. Dispose of toner properly into a trash can. Do not overfill the cartridge by pouring the entire toner powder into the cartridge. Use half the bottle now, and the rest at a later time. Overfilling can and will damage a cartridge.**

Before opening the bottle of toner, turn it upside down and tap it on a table to loosen the toner and allow it to flow freely. Remove the cap and pull the seal off the bottle. Attach the funnel cap making sure it is on tightly. Tilt the funnel cap toward the filling hole and insert it into the hole. If the toner stops flowing before the cartridge is full, simply remove the toner, close the cap, turn the bottle upside down and tap it on a table. Once the cartridge is full seal the hole with the plug or tape.

Once the cartridge is sealed, rock it back and forth to distribute the toner. Remember to replace the chip before inserting the cartridge back into your printer. Once that has been

Replace chip. You may need to modify the chip holding area.



Create refill hole here.



Please be advised that some toner refill kits may be compatible with multiple toner cartridges.



Konica Minolta Magic Color  
4650 / 4690 / 4695

[CLICK HERE TO GO THE INDEX](#)

#### REQUIRED FOR A SUCCESSFUL REFILL:

- Toner
- 1 funnel cap
- Replacement Chip

1. General Refilling Procedures:
2. Please refer to the picture on the right.
3. Expose the toner hopper by sliding the door compartment to the left.
4. Dispose of any toner in the cartridge before refilling, this is very important
5. Before opening the toner bottle, shake thoroughly to loosen any clumps. If your toner requires developer, now would be a good time to add the developer to the bottle to mix with the toner.
6. Once the bottle has been shaken, replace the cap with the funnel cap provided.
7. Pour the entire contents of the bottle into the Toner Hopper. If the funnel is too large to fit in the refilling hole, use a plain sheet of paper to create a smaller funnel that will help guide the toner into the cartridge.
8. Slide the compartment door to the right when you have finished refilling.
9. Replace the chip by removing the screw that holds it in place. (see picture at right-top)
10. Place the cartridge back into your printer and run a test page.
11. Your cartridge is now ready for use.



The screw circled in yellow above must be removed to release chip.

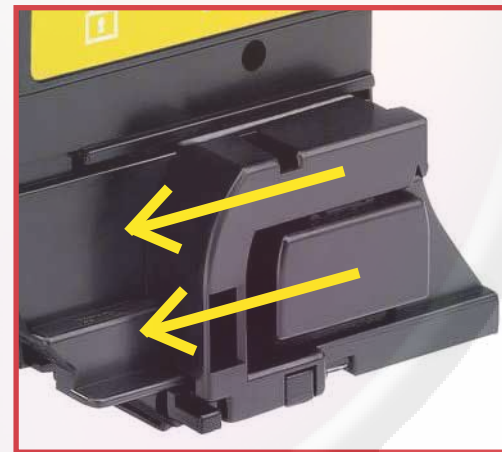

The compartment door in this picture slides to the left and allows the toner hopper hole to be exposed.



Please be advised that some toner refill kits may be compatible with multiple toner cartridges.



Kyocera Mita TK-332 / TK-322 / TK-312

[CLICK HERE TO GO THE INDEX](#)

**REQUIRED FOR A SUCCESSFUL REFILL:**

- Toner
- 1 funnel cap

1. General Refilling Procedures:
2. Please refer to the picture on the right.
3. Remove the Toner Hopper Plug from the cartridge
4. Dispose of any toner in the cartridge before refilling, this is very important
5. Before opening the toner bottle, shake thoroughly to loosen any clumps. If your toner requires developer, now would be a good time to add the developer to the bottle to mix with the toner.
6. Once the bottle has been shaken, replace the cap with the funnel cap provided.
7. Pour the entire contents of the bottle into the Toner Hopper.
8. Replace the plug back onto your cartridge. Make sure the plug is tightly sealed.
9. Place the cartridge back into your printer and run a test page.
10. Your cartridge is now ready for use.



Remove Toner Hopper Plug



Please be advised that some toner refill kits may be compatible with multiple toner cartridges.



Lexmark - 1382760

[CLICK HERE TO GO THE INDEX](#)

#### REQUIRED FOR A SUCCESSFUL REFILL:

- Toner
- 1 funnel cap
- 1 hole plug
- Toner Hole Making Tool

#### General Refilling Procedures:

Rest the Hole Making Tool on its stand and plug into an outlet. Wait 3 full minutes before using. Position the copper bit on the cartridge in the spot indicated by the photograph and push gently until it melts a hole in the cartridge. Look closely in to the cartridge you should see a white internal hopper which also needs to have a hole made in it. Using the hole making tool melt through the white internal cover. Remove the tool, place it back on its stand and unplug it. If the small piece of plastic has fallen into the cartridge, it must be removed, as this can damage your cartridge or cause print defects. If the piece remains in the tool, wait for the tool to cool down and pry it out.

Before opening the bottle of toner, turn it upside down and tap it on a table to loosen the toner and allow it to flow freely. Remove the cap and pull the seal off the bottle. Attach the funnel cap making to sure it is on tightly. Tilt the funnel cap toward the filling hole and insert it into the hole. If the toner stops flowing before the cartridge is full, simply remove the toner, close the cap, turn the bottle upside down and tap it on a table. Once the cartridge is full seal the hole with the plug.

Do not press down on the plug since the cartridge is resting on a table this can actually damage the photo-optic drum. Instead hold one end of the cartridge up off the table and twist the plug until it fully sealed. Now gently shake the cartridge side to side to distribute the toner.

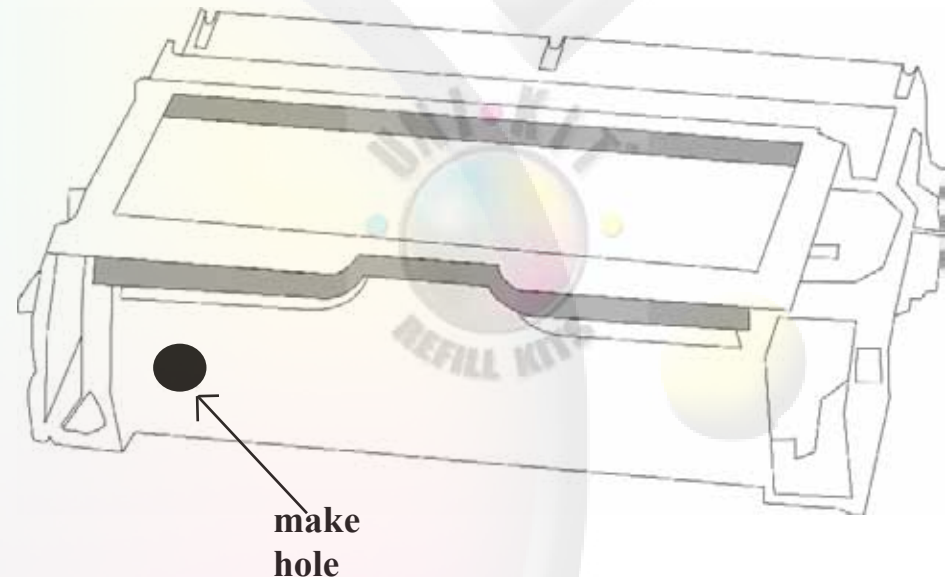

Please be advised that some toner refill kits may be compatible with multiple toner cartridges.



[CLICK HERE TO GO THE INDEX](#)

Lexmark -  
17G0152, 17G0154, 4K00198, 4K00199  
12A5740, 1382625, 1382925, 1382929  
12A5745, 12A5840, 12A5845, 12A5849

#### REQUIRED FOR A SUCCESSFUL REFILL:

- Toner
- 1 funnel cap
- 1 hole plug
- Toner Hole Making Tool

#### General Refilling Procedures:

1. Remove the label on the front of the cartridge.
2. Make a hole using the hole making tool (read general instructions on how to use the hole making tool).
3. Refill by pouring toner into the fill hole through the nozzle attached to the toner bottle. Make sure that you fill using only 1/3 of the toner or less! You can refill again and again, but never put more than 1/3 of toner at one time.
4. Seal the hole using the sealing plug provided.
5. The smartchip needs to be replaced before the printer will recognize the refilled cartridge. If you do not have a smartchip please check with your place of purchase or contact us at support@uni-kit.com. To replace the chip simply strip the old one from the cartridge, and apply the new one in its place (the chip has adhesive backing).

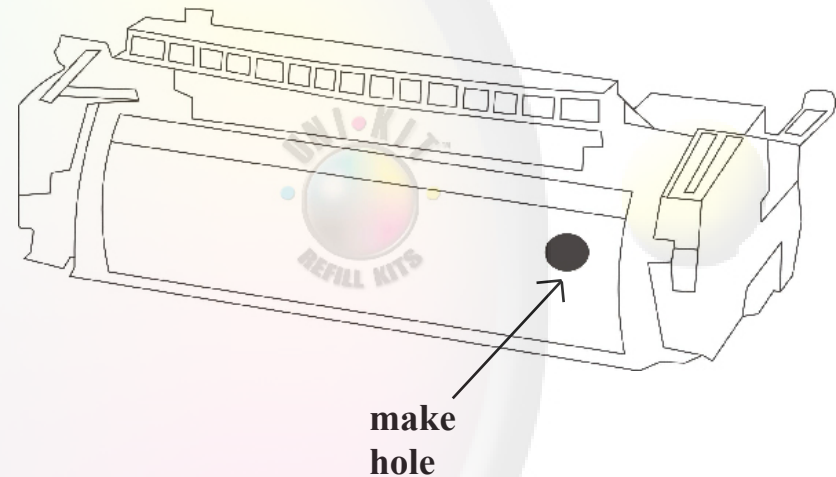

Please be advised that some toner refill kits may be compatible with multiple toner cartridges.



LEXMARK T630 / T632 / T634/T640/T644  
DELL M5200 and more

[CLICK HERE TO GO THE INDEX](#)

#### REQUIRED FOR A SUCCESSFUL REFILL:

- Toner
- 1 funnel cap
- Toner Hole Making Tool

#### OPTION #1

#### *General Refilling Procedures:*

1. Plug in your hole making tool and let it heat up for about 5-10 min. Please make sure you place the hole making tool in a clear area and use the hole making tool holder to set the tool on. This tool gets extremely hot and you must use extreme caution when handling this item (read general instructions on how to use the hole making tool).
2. Using your hole making tool, make a hole in the area shown in illustration B. When creating a hole in any cartridge, do not forcefully push the tool thru as their might be other parts that lie inside the cartridge that can be damaged if done incorrectly. Gently push into the cartridge creating the hole. If the small piece of plastic, that the hole making tool has created, falls inside the cartridge, it must be removed, as this can damage your cartridge or cause print defects. If the piece remains in the tool, wait for the tool to cool down and pry it out.
3. Before refilling the cartridge, make sure you remove all the toner from inside the cartridge. Mixing two different brands of toner may result in bad prints. Refill by pouring toner into the fill hole through the nozzle attached to the toner bottle. Each bottle is good for one refill in your cartridge, if your not sure about using the hole bottle, you can always come back to it later and fill in the rest.
4. Seal the hole using electrical tape or duct tape.
5. The smartchip needs to be replaced before the printer will recognize the refilled cartridge. If you do not have a smartchip please check with your place of purchase or contact us at support@uni-kit.com. To replace the chip simply strip the old one from the cartridge, and apply the new one in its place (some chips may have adhesive backs for easy replacement).



Create refill hole here

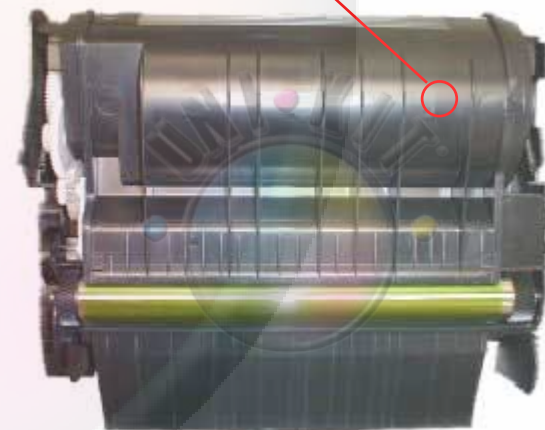



Please be advised that some toner refill kits may be compatible with multiple toner cartridges.



LEXMARK T640/T644

[CLICK HERE TO GO THE INDEX](#)

OPTION #2



Start by placing the cartridge with the drum side up and the toner hopper near you



Disengage the two springs holding the sections together using a spring hook or small pointed pliers.



Open slightly one of the lateral edges to release the post engaging the toner hopper and the drum section together. Then repeat with the opposite side.



4. With one hand pull the hopper section out while holding the drum section steady then repeat with the second post. Pull hopper straight out to liberate the white bearings inside.



5. Take the Hopper Section and inspect the encoder wheel. It has probably been heat-welded against the plastic shaft requiring certain care during its removal. Insert a pair of long nose pliers to access the shaft at the center beneath the wheel and pry it off.



6. Remove the complete white fill plug at the side of the hopper. This is done by prying it open at the base near the border of the hole using a small flathead screwdriver. Opening the breather section (top portion of plug) does not give access to the hopper.



Refill the cartridge, once you are finished refilling, you may reassemble the cartridge.



Please remember to replace the chip before installing your cartridge back into your printer.



Please be advised that some toner refill kits may be compatible with multiple toner cartridges.



Lexmark – 1382100/1382150/1380850/1380950  
/1380200/1380520  
Genicom – 6A0133P01/6A0134P01

[CLICK HERE TO GO THE INDEX](#)

#### REQUIRED FOR A SUCCESSFUL REFILL:

- Toner
- 1 funnel cap
- 1 hole plug
- Toner Hole Making Tool

#### *General Refilling Procedures:*

Rest the Hole Making Tool on its stand and plug into an outlet. Wait 3 full minutes before using. Position the copper bit on the cartridge in the spot indicated by the photograph and push gently until it melts a hole in the cartridge. Look closely in to the cartridge you should see a white internal hopper which also needs to have a hole made in it. Using the hole making tool melt through the white internal cover. Remove the tool, place it back on its stand and unplug it. If the small piece of plastic has fallen into the cartridge, it must be removed, as this can damage your cartridge or cause print defects. If the piece remains in the tool, wait for the tool to cool down and pry it out.

Before opening the bottle of toner, turn it upside down and tap it on a table to loosen the toner and allow it to flow freely. Remove the cap and pull the seal off the bottle. Attach the funnel cap making sure it is on tightly. Tilt the funnel cap toward the filling hole and insert it into the hole. If the toner stops flowing before the cartridge is full, simply remove the toner, close the cap, turn the bottle upside down and tap it on a table. Once the cartridge is full seal the hole with the plug.

Do not press down on the plug since the cartridge is resting on a table this can actually damage the photo-optic drum. Instead hold one end of the cartridge up off the table and twist the plug until it fully sealed. Now gently shake the cartridge side to side to distribute the toner.

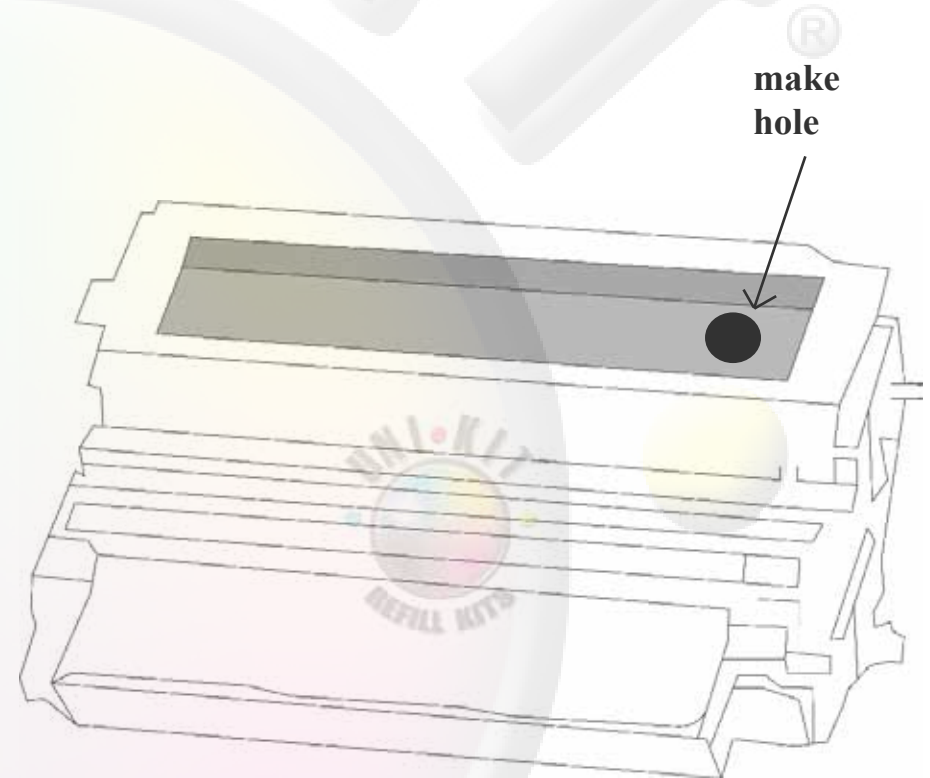

Please be advised that some toner refill kits may be compatible with multiple toner cartridges.



Lexmark – 140109A

[CLICK HERE TO GO THE INDEX](#)

#### REQUIRED FOR A SUCCESSFUL REFILL:

- Toner
- 1 funnel cap
- 1 hole plug
- Toner Hole Making Tool

#### *General Refilling Procedures:*

Rest the Hole Making Tool on its stand and plug into an outlet. Wait 3 full minutes before using. Turn the cartridge up in its left side. Position the copper bit on the cartridge in the spot indicated by the photograph and push gently until it melts a hole in the cartridge. Make sure to keep the hole on the flat surface of the cartridge and not on the curved edge. Remove the tool, place it back on its stand and unplug it. If the small piece of plastic has fallen into the cartridge, it must be removed, as this can damage your cartridge or cause print defects. If the piece remains in the tool, wait for the tool to cool down and pry it out.

Before opening the bottle of toner, turn it upside down and tap it on a table to loosen the toner and allow it to flow freely. Remove the cap and pull the seal off the bottle. Attach the funnel cap making to sure it is on tightly. Tilt the funnel cap toward the filling hole and insert it into the hole. If the toner stops flowing before the cartridge is full, simply remove the toner, close the cap, turn the bottle upside down and tap it on a table. Once the cartridge is full seal the hole with the plug.

Do not press down on the plug since the cartridge is resting on a table this can actually damage the photo-optic drum. Instead hold one end of the cartridge up off the table and twist the plug until it fully sealed. Now gently shake the cartridge side to side to distribute the toner.

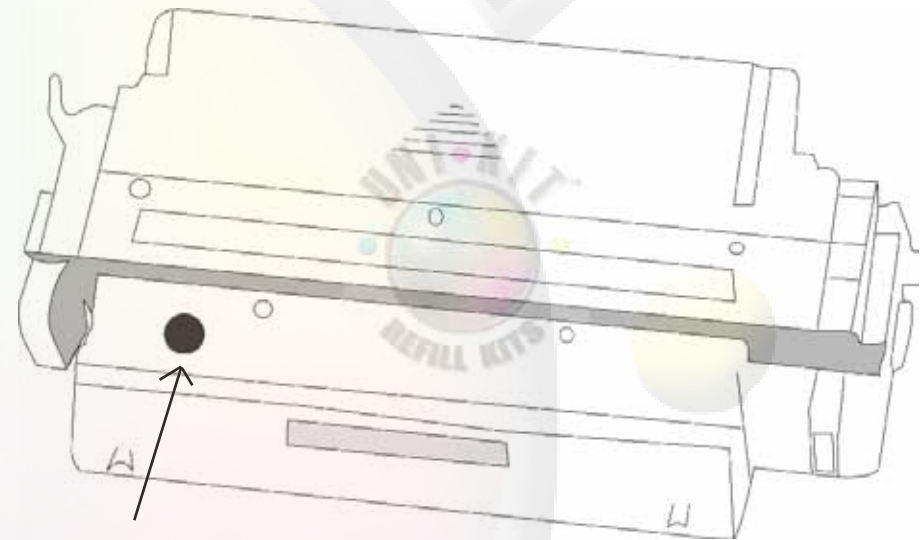

make  
hole

Please be advised that some toner refill kits may be compatible with multiple toner cartridges.



Lexmark – 13T0101  
Xerox – 113R296  
Samsung – ML5000/TD55K

[CLICK HERE TO GO THE INDEX](#)

#### REQUIRED FOR A SUCCESSFUL REFILL:

- Toner
- 1 funnel cap
- Hole Making Tool
- Replacement Fuse

#### General Refilling Procedures:

Use a screwdriver to remove the three small screws holding the end cap in place. In order to remove the end cap the drum shutter arm must be disengaged from a hole in the end cap. Open the drum shutter door and disengage the pin from the side of the cartridge. Now carefully wiggle the end cap loose. Press down on the existing fuse. Use a screwdriver and gently but firmly press down on the fuse from the top side of the end cap. Turn the end over and remove the fuse. Press the replacement fuse back in place until it snaps in. Now reassemble the end cap and reinsert the drum shutter arm and replace the screws.

Rest the Hole Making Tool on its stand and plug into an outlet. Wait 3 full minutes before using. Position the copper bit on the cartridge in the spot indicated by the photograph and push gently until it melts a hole in the cartridge. Make sure to keep the hole on the flat surface of the cartridge and not on the curved edge. Remove the tool, place it back on its stand and unplug it. If the small piece of plastic has fallen into the cartridge, it must be removed, as this can damage your cartridge or cause print defects. If the piece remains in the tool, wait for the tool to cool down and pry it out.

Before opening the bottle of toner, turn it upside down and tap it on a table to loosen the toner and allow it to flow freely. Remove the cap and pull the seal off the bottle. Attach the funnel cap making to sure it is on tightly. Tilt the funnel cap toward the filling hole and insert it into the hole. If the toner stops flowing before the cartridge is full, simply remove the toner, close the cap, turn the bottle upside down and tap it on a table. Once the cartridge is full, seal the hole with the plug by twisting it until it is completely seated.

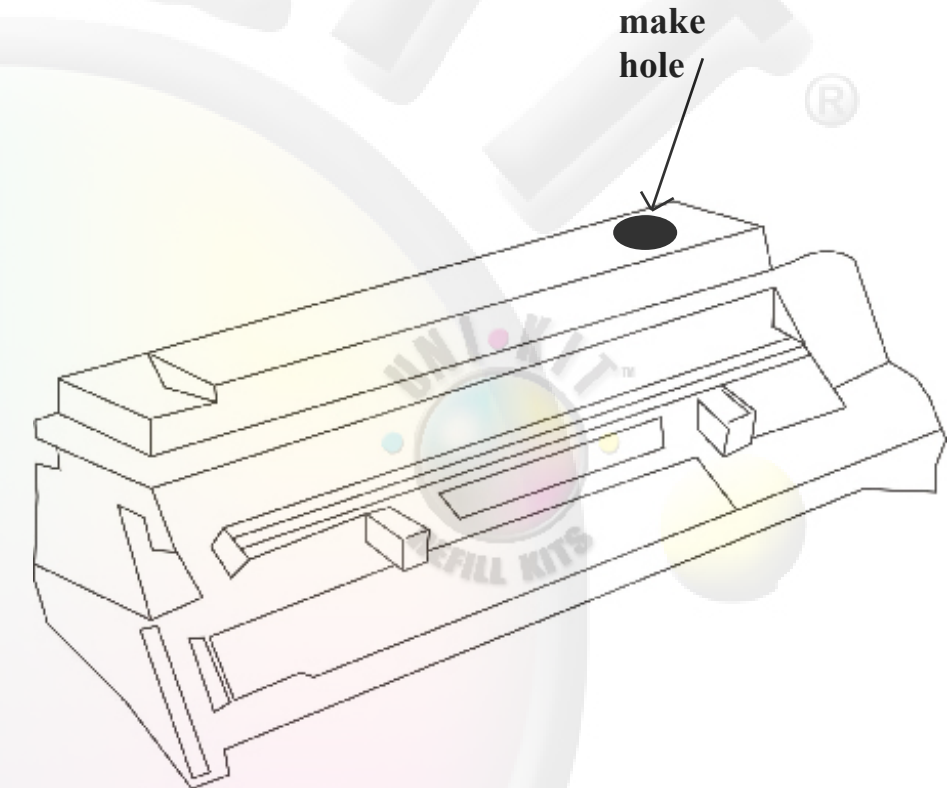

Do not press down on the plug since the cartridge is resting on a table this can actually damage the photo-optic drum. Instead hold one end of the cartridge up off the table and twist the plug until it fully sealed. Now gently shake the cartridge side to side to distribute the toner.

Please be advised that some toner refill kits may be compatible with multiple toner cartridges.



LEXMARK C510 / C710  
BROTHER TN04/ RICOH TYPE 140

[CLICK HERE TO GO THE INDEX](#)

#### REQUIRED FOR A SUCCESSFUL REFILL:

- Toner refill kit
- Needle nose pliers
- Hole Making Tool
- Duct Tape or Electrical Tape

Note: Please read carefully before refilling cartridge.

#### General Refilling Procedures:

Using the needle nose pliers, remove toner hopper plug (please refer to the illustration on the right).

**IMPORTANT:** You must dispose of any original toner in the cartridge as much as possible before refilling. Dispose of toner properly into a trash can, or use a vacuum with a hose for best results (if possible).

Before opening the bottle of toner, turn it upside down and tap it on a table to loosen the toner and allow it to flow freely. Remove the cap and pull the seal off the bottle. Attach the funnel cap making sure it is on tightly. Tilt the cartridge at a 45 degree angle and then the funnel cap toward the filling hole and insert it into the hole. If the toner stops flowing before the cartridge is full, simply remove the toner, close the cap, turn the bottle upside down and tap it on a table. Once you are done refilling the cartridge, place the plug back in its place (do not push the plug in too hard or it will be pushed into the cartridge). Use duct tape or electrical tape to seal up any necessary cracks on the plug.

The cartridge is now ready for use.

Note: If your cartridge does not have a plug, you will require a hole making tool to create one. The refill hole should be created in the same place the plug is shown (The picture to the right can be used as a guide).



Option #1

Remove Plug and Refill



Brother TN04 Cartridge may require hole making tool

Option #2





Please be advised that some toner refill kits may be compatible with multiple toner cartridges.



LEXMARK C910 / C912 / C920

[CLICK HERE TO GO THE INDEX](#)

#### REQUIRED FOR A SUCCESSFUL REFILL:

- Toner
- 1 funnel cap

#### General Refilling Procedures:

Use a screwdriver to remove the small screws holding the end-cap in place. Remove the end cap gently incase there are any lose gears inside. Use a flathead screwdriver to pop out the large plastic plug found on the side of the cartridge.

***IMPORTANT: You must dispose of any original toner in the cartridge as much as possible before refilling. Dispose of toner properly into a trash can. Do not overfill the cartridge by pouring the entire toner powder into the cartridge. Use half the bottle now, and the rest at a later time. Overfilling can and will damage a cartridge.***

Before opening the bottle of toner, turn it upside down and tap it on a table to loosen the toner and allow it to flow freely. Remove the cap and pull the seal off the bottle. Attach the funnel cap making making sure it is on tightly. Tilt the funnel cap toward the filling hole and insert it into the hole. If the toner stops flowing before the cartridge is full, simply remove the toner, close the cap, turn the bottle upside down and tap it on a table. Once the cartridge is full, seal the hole with the plug by twisting it until it is completely seated.

Reassemble the cartridge. Now gently shake the cartridge side to side to distribute the toner.

A.



B.

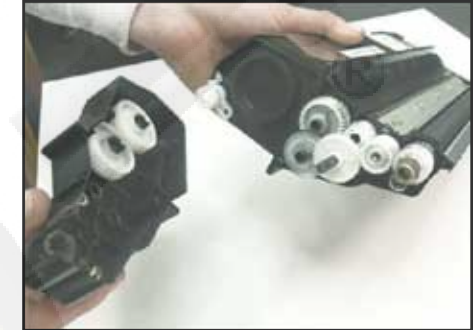

C.



D.



E.



Please be advised that some toner refill kits may be compatible with multiple toner cartridges.



LEXMARK C522 / C524 / C530 / C532 / C534

[CLICK HERE TO GO THE INDEX](#)

#### REQUIRED FOR A SUCCESSFUL REFILL:

- Toner
- 1 funnel cap

#### General Refilling Procedures:

Using a T-10 Torx screwdriver remove the two screws either side of the doctor blade. Using a Philips screwdriver remove the two screws and washers from the centre of the doctor blade (picture 1). Remove the top metal strip from the cartridge. Lift out the doctor blade (picture 2 & 3). Remove the two screws holding the blue cartridge handle in place on the non-gear side of the cartridge (picture 4 & 5).

Note: *the bottom screw is longer than the top screw. The metal contact strip and blue handle can be removed from the hopper unit.*

To remove the developer roller – this can be twisted and pulled out from the white gear side of the cartridge.

Optional: *Use Isopropanol Alcohol to clean the developer roller, although there are a number of roller cleaning agents available (picture 9).*

**IMPORTANT: You must dispose of any original toner in the cartridge as much as possible before refilling. Dispose of toner properly into a trash can, or use a vacuum with a hose for best results (if possible).**

Before opening the bottle of toner, turn it upside down and tap it on a table to loosen the toner and allow it to flow freely. Remove the cap and pull the seal off the bottle. Attach the funnel cap making sure it is on tightly. Refill the cartridge directly through the developer roller area (picture 10). If the toner stops flowing before the cartridge is full, simply remove the toner, close the cap, turn the bottle upside down and tap it on a table. Once the cartridge is full, seal the hole with the plug by twisting it until it is completely seated.

Reassemble the cartridge. Now gently shake the cartridge side to side to distribute the toner.

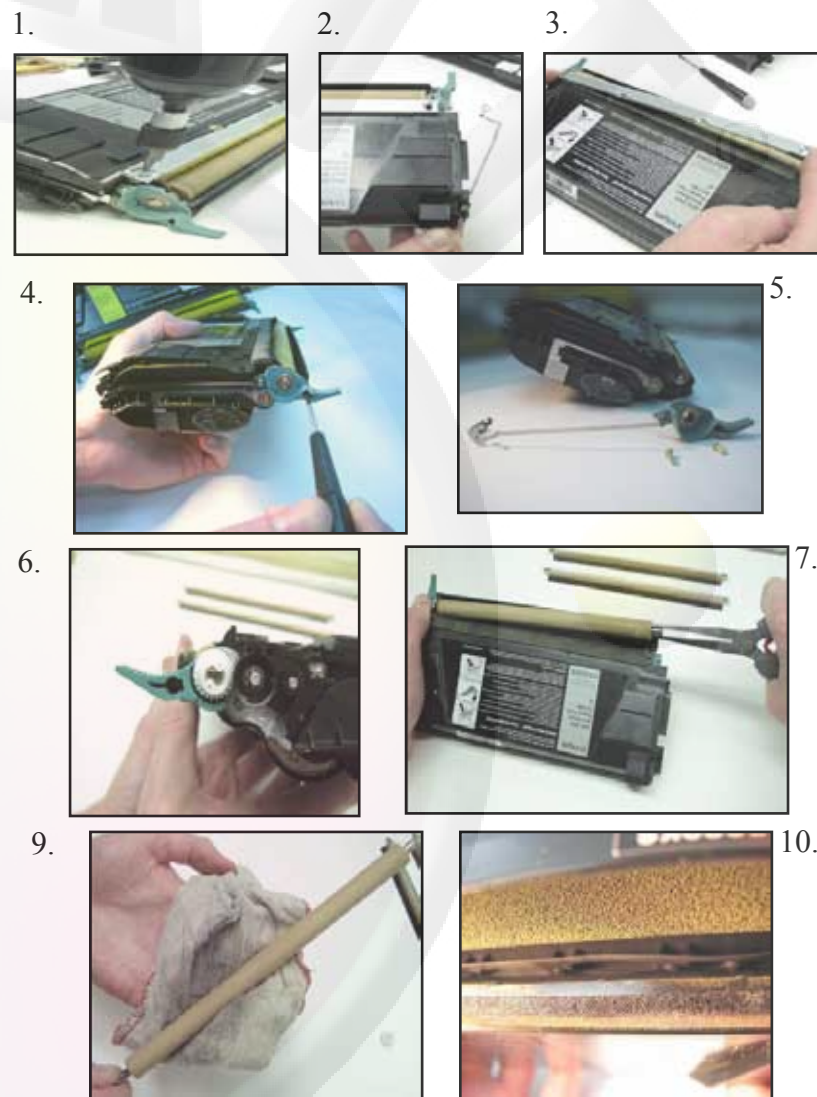

For Chip replacement please see next page...

Please be advised that some toner refill kits may be compatible with multiple toner cartridges.



LEXMARK C522

[CLICK HERE TO GO THE INDEX](#)

## Chip replacement:

The Lexmark cartridge uses a chip. To replace the cartridge chip remove the three screws located beside the cartridge gears.

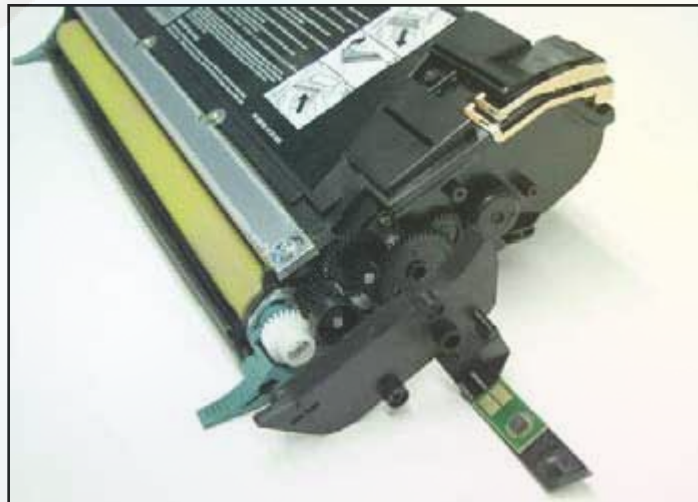



Please be advised that some toner refill kits may be compatible with multiple toner cartridges.



## LEXMARK T420

[CLICK HERE TO GO THE INDEX](#)

### REQUIRED FOR A SUCCESSFUL REFILL:

- Toner
- 1 funnel cap
- 1 replacement chip

### General Refilling Procedures:

1. First you need to locate the plastic SEALING PLUG similar to the one shown in this diagram. To access the plug, you may need to remove some springs which hold the END CAP over this plug. Please look at diagrams A-E, In steps A and B you remove the springs on the cartridge (Make sure these do not break, bend, or get lost as you will need them again). In step C, start to remove the side panel by gently lifting it from the cartridge, and then pulling away from the cartridge. You will need to complete step D to fully remove the casing off the cartridge that will give you full access to the toner refill hole (diagram E).
2. Once the plastic sealing plug is viewable, slowly and gently, pry the SEALING PLUG away from the cartridge using a flat head screwdriver – this reveals the filling hole.
3. Refill by pouring toner into the fill hole through the nozzle attached to the toner bottle.
4. Replace the plug when finished refilling
5. This cartridge has a MEMORY CHIP which needs to be replaced in order for the printer to sense that there is toner in the cartridge. Simply remove the old chip by

A.



B.



C.

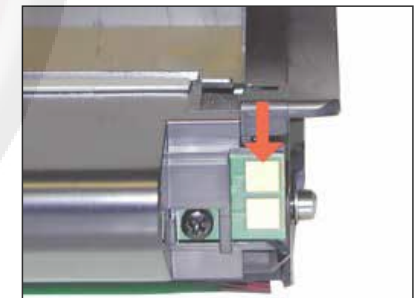
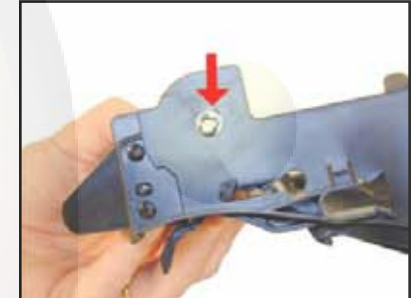



Please be advised that some toner refill kits may be compatible with multiple toner cartridges.



LEXMARK e250 / 350 / 450

[CLICK HERE TO GO THE INDEX](#)

#### REQUIRED FOR A SUCCESSFUL REFILL:

- Toner
- 1 funnel cap
- 1 replacement chip

#### General Refilling Procedures:

1. First you need to locate the plastic SEALING PLUG similar to the one shown in this diagram. Some cartridges may require you to remove a plastic cover that lays over the cartridge.
2. Once the plastic sealing plug is viewable, slowly and gently, pry the SEALING PLUG away from the cartridge using a flathead screwdriver – this reveals the filling hole.
3. Refill by pouring toner into the fill hole through the nozzle attached to the toner bottle.
4. Replace the plug when finished refilling
5. This cartridge has a MEMORY CHIP which needs to be replaced in order for the printer to sense that there is toner in the cartridge. Simply remove the old chip by unscrewing the 2 screws that hold it in place, and screw the new replacement chip in its place.

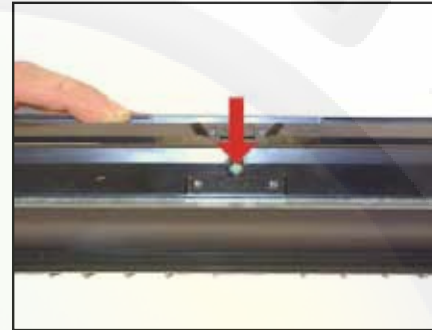

## Chip Replacement

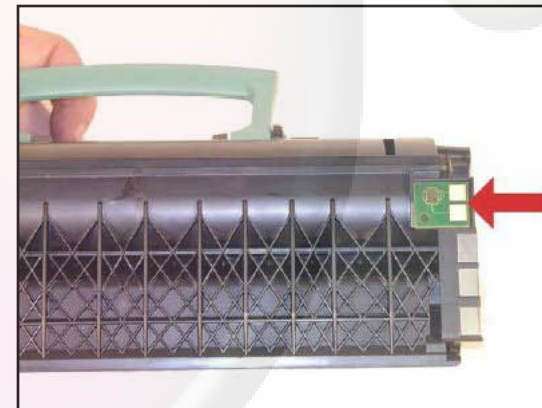

To replace the chip, simply unscrew the chip from its place holder discard of it properly, and replace it with the new one.

Please be advised that some toner refill kits may be compatible with multiple toner cartridges.



KONICA MINOLTA 1300 / 1350

[CLICK HERE TO GO THE INDEX](#)

#### REQUIRED FOR A SUCCESSFUL REFILL:

- Toner
- 1 funnel cap
- 1 replacement chip

#### *General Refilling Procedures:*

1. First you need to locate the plastic SEALING PLUG similar to the one shown in this picture to the right.
2. Once the plastic sealing plug is viewable, slowly and gently, pry the SEALING PLUG away from the cartridge using a flat screwdriver – this reveals the filling hole.
3. Remove any toner left in the cartridge before refilling the cartridge.
4. Refill by pouring toner into the fill hole through the nozzle attached to the toner bottle.
5. Replace the plug when finished refiling
6. This cartridge has a MEMORY CHIP which needs to be replaced in order for the printer to sense that there is toner in the cartridge. Simply remove the old chip by unscrewing the 2 screws that hold it in place, and screw the new replacement chip in its place. Please be aware that the replacement chip may have one hole compared to the original. Make any needed modifications to fit the chip in place.



Please be advised that some toner refill kits may be compatible with multiple toner cartridges.



KONICA MINOLTA PAGE PRO 1400W

[CLICK HERE TO GO THE INDEX](#)

#### REQUIRED FOR A SUCCESSFUL REFILL:

- Toner
- 1 funnel cap
- 1 replacement chip

#### General Refilling Procedures:

1. First you need to locate the plastic SEALING PLUG similar to the one shown in this picture to the right.
2. Once the plastic sealing plug is viewable, slowly and gently, pry the SEALING PLUG away from the cartridge using a flat screwdriver – this reveals the filling hole.
3. Remove any toner left in the cartridge before refilling the cartridge.
4. Refill by pouring toner into the fill hole through the nozzle attached to the toner bottle.
5. Replace the plug when finished refiling
6. This cartridge has a MEMORY CHIP which needs to be replaced in order for the printer to sense that there is toner in the cartridge. Simply remove the old chip by unscrewing the 2 screws that hold it in place, and screw the new replacement chip in its place. Please be aware that the replacement chip may have one hole compared to the original. Make any needed modifications to fit the chip in place.



Toner Hopper Plug



Remove original chip, replace with new chip.



Please be advised that some toner refill kits may be compatible with multiple toner cartridges.



KONICA MINOLTA 5430

[CLICK HERE TO GO THE INDEX](#)

**IMPORTANT:** You must dispose of any original toner in the cartridge as much as possible before refilling. Dispose of toner properly into a trash can, or use a vacuum with a hose for best results (if possible).

1. Always refill at a workbench or outside and in a well ventilated environment where you can tolerate a spill.
2. **IMPORTANT:** Complete removal of the original toner is necessary before you refill with Uni-Kit toner. Failure to completely remove any remaining original toner may result in blotchy prints or a leaking cartridge.
3. In picture A, the toner hopper unit is situated at the top (Blue rectangle), with the developer section at the bottom (Yellow Rectangle), and the chip section to the left (Red rectangle). The 8 screws along the left hand side (8 screws circled in red in picture B) need to be removed in order to give access to the sections seen in picture A. Please be very careful when pulling apart the sides of the cartridge, there are loose gears that might fall out during the process. If this happens, refer to picture G as a reference to how the gears are in place correctly.
4. The refill hole is located on the toner hopper unit, and can be refilled by removing the plastic plug (The plastic plug is circled in yellow in picture C). **IMPORTANT:** There is a hole on the bottom part of the toner hopper that needs to be covered when refilling the cartridge. You can use your thumb to cover this hole as you refill the cartridge. When you are done refilling the toner hopper, plug it with the large plug we provided you with and place the toner hopper section down with the hole in picture D facing upward.
5. The next step requires you to empty the toner waste hopper which is located in the bottom back side of the the cartridge (Please refer to picture A as a reference). Picture A shows the front side of the waste hopper to be located on the bottom left hand side. In picture E we show the back side of the toner waste hopper. With the hole making tool, carefully and cautiously, create a hole in reference to the blue circle in picture E. Once you have created this hole, it is safe to unplug the tool and rest it aside on the holder (Please be caution that the tool will remain very hot for several minutes and is recommended for it to be placed out of harms way). Please empty as much of the toner as possible from the toner waste hopper through the hole you have just created. Once you are finished, plug the hole with the smaller toner plug provided in your refill kit or use duct tape (electrical tape will also work) to securely seal the hole.
6. Please Continue to the next page for instructions on replacing the chip (Do not reassemble the cartridge at this time).

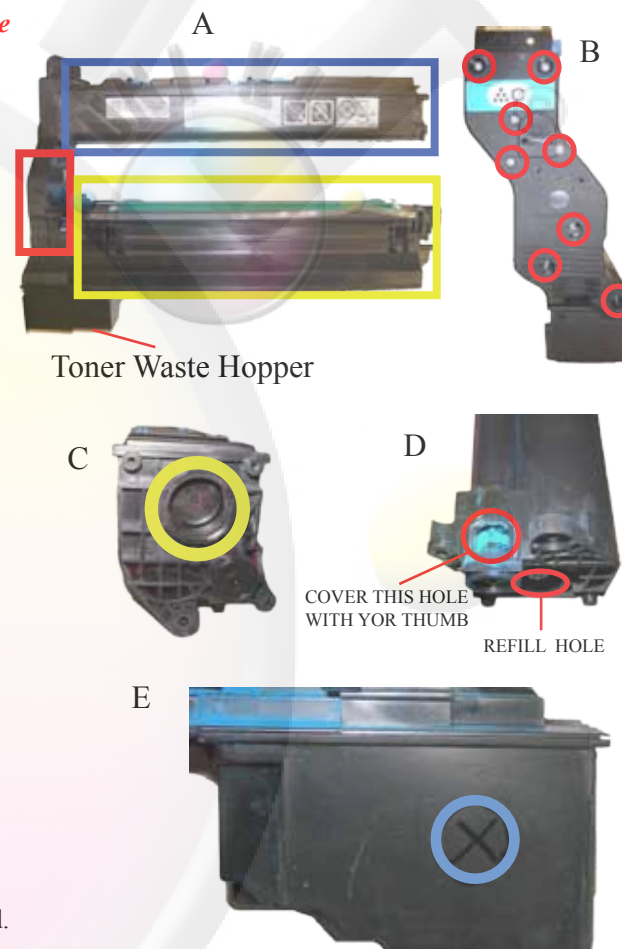

© All rights reserved, Easy Group, LLC. Version 3.0

All trademarks are property of their respective owners. Uni-Kit® has no association with any of the manufacturers listed here such as Hp, Epson, Lexmark, Xerox, etc. All logos and brand names shown here are used for identification purposes only. It is illegal to reproduce these instructions without written licensing consent from Easy Group LLC.

Please be advised that some toner refill kits may be compatible with multiple toner cartridges.



## KONICA MINOLTA 5430 SMARTCHIP REPLACEMENT

[CLICK HERE TO GO THE INDEX](#)

Continued from page 21

7. If you haven't done so already, disconnect the developer section of the cartridge (Please refer to the refill Instructions and look at picture A).
8. In picture F we see the OEM chip as it sits in the cartridge. The OEM chip is cradled between the cartridge. In order to remove or replace this chip, all screws from picture B (Picture B is on page 21) must be removed to expose the inner side of the compartment. Be very careful when pulling apart the sides of the cartridge, there are loose gears that might fall out during the process. If this happens, refer to picture G as a reference to how the gears are in place correctly.
9. Picture H and I show you the inside to where the chip is chambered. Picture H is the inside look of Picture F (this is so you get a better understanding on how the chip is cradled). In picture I, the chip holder is highlighted with a red circle. As you can see, there are small pins that allow the OEM chip be held in place (pins are circled green in picture I). Before installing the replacement chip, you will need to clip away these pins in order for the replacement chip to fit properly. Once you have done this, you will drop the chip inside the compartment circled in red in picture H. The correct position of the chip should be to that in picture F. Now carefully combine both pieces from picture H and I together to lock the chip in correctly.
10. You can now reassemble the entire cartridge. **IMPORTANT:** Remember to be careful when putting the toner hopper back in place. Some toner may and can fall out from the small hole in picture D (Picture D is on page 21). Once you are finished reassembling the cartridge, shake the cartridge side to side to distribute the toner.

**IMPORTANT:** You must dispose of any original toner in the cartridge as much as possible before refilling. Dispose of toner properly into a trash can, or use a vacuum with a hose for best results (if possible). Do not overfill the cartridge by pouring the entire toner powder into the cartridge. Use half the bottle now, and the rest at a later time. Overfilling can and will damage a cartridge.

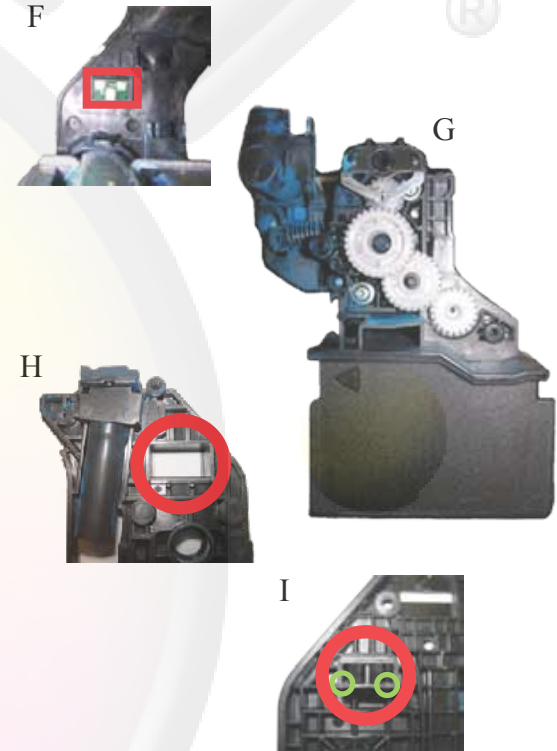



## REFILL INSTRUCTIONS

Please be advised that some toner refill kits may be compatible with multiple toner cartridges.

KONICA MINOLTA QMS 2300 / 2350  
EPSON C900 / C1900

[CLICK HERE TO GO THE INDEX](#)



1. Remove one screw then remove the plastic part.



2. This exposes the cap which seals the filling hole.



3. Remove the cap by inserting the tip of a screw driver and twisting it carefully. Now you can pour toner into the cartridge by attaching the nozzle to the bottle.

### GENERAL COMMENTS:

Sometimes the QMS 2300 printer will not recognize the refilled cartridge. The only way to overcome this is to “RESET” the cartridge. Reset instructions are provided separately. It is always better to underfill than to overfill a cartridge. You can always add more toner later. Uni-Kit toner is researched and tested to produce excellent results - your first refill should be nearly 100% same quality as the original cartridge. It is recommended that you refill the same cartridge no more than 2-3 times, because with each print cycle the cartridge will wear and tear and quality will slowly diminish.

### QMS 2300 SENSOR RESET INSTRUCTIONS

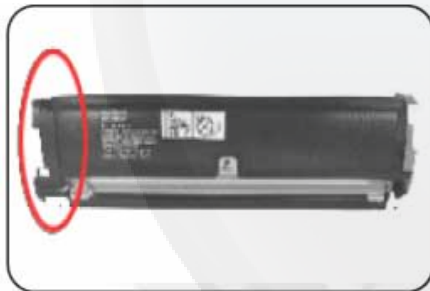

Brand-New (Unused) OEM Cartridge

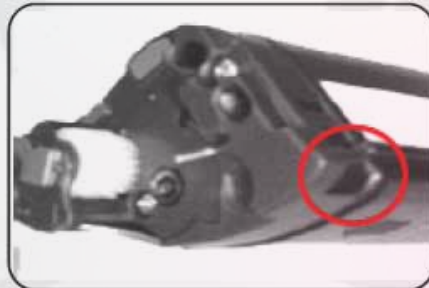

Used OEM Cartridge

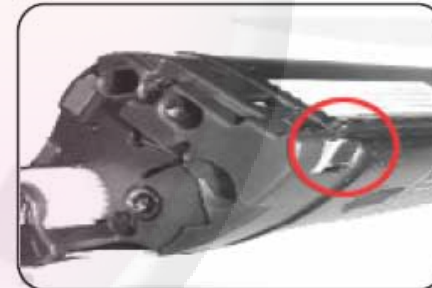

The QMS 2300 sensor is a small, white plastic piece, located on the cartridge edge as shown in the circle above.

When the cartridge is placed into the printer, the sensor (see red circle) gets ejected out of the cartridge. When refilling the cartridge, the sensor must be pushed back into the cartridge in order to reset it otherwise the printer will show an error.



Please be advised that some toner refill kits may be compatible with multiple toner cartridges.



## KONICA MINOLTA QMS 2300 SENSOR RESET INSTRUCTIONS

[CLICK HERE TO GO THE INDEX](#)



1. Remove the three screws with a screwdriver as shown above.

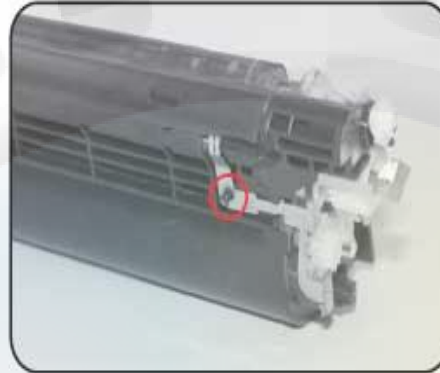

2. Now locate the fourth screw (shown above) and remove it. This will allow you to remove the endcap. Caution: When removing the end cap, be careful not to damage the copperplate on the cartridge body.

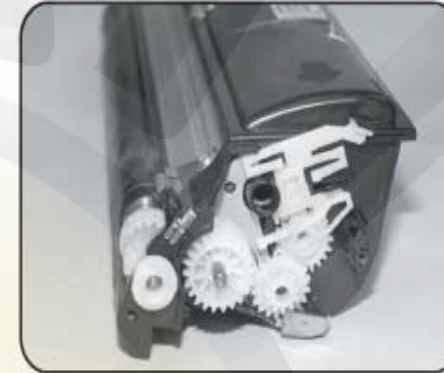

3. The bottom portion of the sensor has toothed gears. It is important that you position the sensor so that the teeth of the sensor align with the bottom gear teeth. The above picture shows what it should look like if done properly.

**NOTE:** It is important that the teeth mesh if you hear a grinding noise after resetting the cartridge and placing it in the printer then the teeth have not meshed. You need to open the cartridge and reset the sensor.



4. Reattach the endcap to the cartridge with the four screws you removed in steps 1 and 2. Check that the copperplate fits the cartridge properly. Your cartridge should now be successfully reset



Please be advised that some toner refill kits may be compatible with multiple toner cartridges.



## KONICA MINOLTA QMS 2300 SENSOR RESET INSTRUCTIONS

[CLICK HERE TO GO THE INDEX](#)

### TROUBLESHOOTING

NOTE: Only use this procedure when necessary such as if the Developer Roller indicates a problem, contamination, lines etc.



1. Unscrew the three gold screws on the side of the cartridge along with the screw on the copper contact.

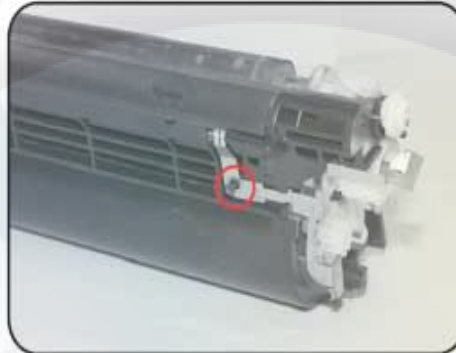

2. Carefully lift the contact and remove the end cap. You should also remove the white gears.



3. Remove the doctor blade by unscrewing the screws. You should gently wipe in one direction, or remove any obstacles.

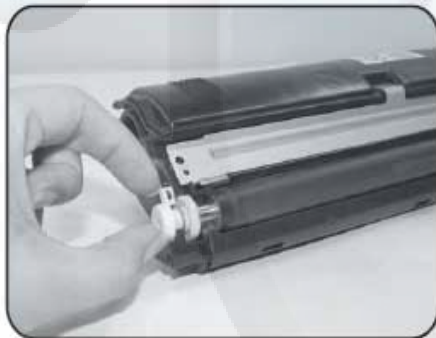

4. Remove the developer roller by turning the white endcap on the gear side and lifting roller out.

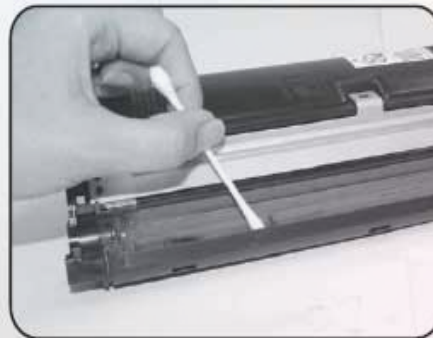

5. Recovery blades should be gently cleaned with a Q-tip without applying pressure.



6. Clean the developer roller by blowing it off or carefully wiping it. NOTE: Do not use a vacuum or touch the smaller supply roller.

Please be advised that some toner refill kits may be compatible with multiple toner cartridges.



## REFILL INSTRUCTIONS

KONICA MINOLTA QMS 2200 / 2400  
EPSON C1000 / C2000 / C3000  
XEROX 6120

[CLICK HERE TO GO THE INDEX](#)

**Note:** For the QMS 2400 cartridge, there is a similar plug that as the QMS 2200 on the opposite side of the cartridge that is semi-rigid but easily removable with a pair of pliers. You do not need a screwdriver to expose that plug. Remove it with a pair of pliers and you have exposed the filling hole.

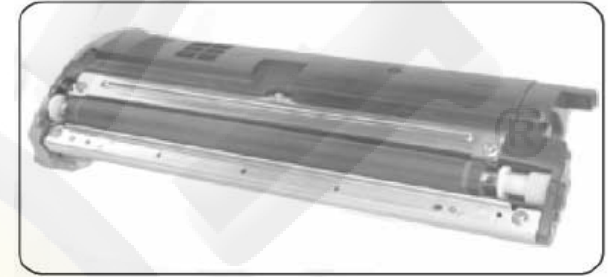

1. Using a screwdriver remove 1 screw from the side of cartridge



2. This will expose the cap as shown. The filling hole is behind this cap. Remove this cap carefully. Then remove the plastic cover.



3. Attach the pouring nozzle to the refill bottle and pour the toner into the cartridge

## GENERAL COMMENTS:

It is always better to underfill than to overfill a cartridge. You can always add more toner later.

Uni-Kit toner is researched and tested to produce excellent results - your first refill should be nearly 100% same quality as the original cartridge. It is recommended that you refill the same cartridge no more than 2-3 times, because with each print cycle the cartridge will wear and tear and quality will slowly diminish.

Please be advised that some toner refill kits may be compatible with multiple toner cartridges.



KONICA MINOLTA QMS 2400 Series  
Xerox 6120

[CLICK HERE TO GO THE INDEX](#)

The following reset procedure will enable the printer to continue printing even though the toner level will say “empty”.

### Magicolor 2400 Series

#### STEP 1

You need to find the STATUS DISPLAY icon for your QMS 2400 printer. To locate this icon, go to START □ PROGRAMS □ KONICA MINOLTA 2400 UTILITIES □ and then select “STATUS”.

#### STEP 2

In the menu bar on top, select “PRINTER” and then select “MODE SETTING”.

#### STEP 3

Uncheck the “AUTO TONER REPLACE” and then save or click OK if prompted

#### STEP 4

Now turn your printer off, and then turn it back on a few seconds later.

### Magicolor 2430 Series

#### STEP 1

On your Magicolor 2430 series printer, make sure the panel display says “READY”. Then press the MENU/SELECT button.

#### STEP 2

By scrolling with the right arrow button, continue until you stop at selection “ENGINE”. Now press the MENU/SELECT button again.

#### STEP 3

Scroll again with the right arrow button until you get to “TONER EMPTY”. Press the MENU/SELECT button again.

#### STEP 4

Press the right arrow button until you get to “TONER IS EMPTY OR OUT”

#### STEP 5

Press MENU/SELECT button once more, and then press the UP arrow until you see “READY”.

### INSTRUCTIONS ON HOW TO REPLACE THE CHIPS

Replacement chips are available for those customers who want to restore the “toner level monitoring” features that the chips have. If you have bought the replacement chip, please follow these simple chip replacement instructions:

- 1) Remove the old chip by first removing the screw in the top left hand corner of the diagram below
- 2) If your cartridge has an original chip with TWO holes in it (same as the photo below) and if the chip you have bought only has ONE hole, then you need to follow step (3). If your cartridge does not look like the photo below, then move on to step (4)
- 3) --- you can skip this step if your cartridge does not look like the one in the photo below --- Using a flat utility knife or blade, cut the plastic protrusion that is behind the chip on the top right corner. This plastic protrusion sticks through the original QMS 2400 chip but has no purpose. If the replacement chip you purchased does not have a hole for this protrusion to fit into, the protrusion will push on the chip unless you shave away at the protrusion by 1-2 mm. Then the new replacement chip can sit snugly over the protrusion and not stick out.
- 4) Replace the new chip by replacing the screw and the new chip in the same orientation

Photo of a chip with TWO holes and a protrusion jutting through the right hole.

If the new chip you have only has ONE hole on the left, follow step (3) above.





Please be advised that some toner refill kits may be compatible with multiple toner cartridges.



OKIDATA C5100 / C5150 / C5200 / C5300 / C5400 / C7100 / C 7200  
C7300 / C7500/ B4100 / B4200 / B4300

[CLICK HERE TO GO THE INDEX](#)

ALWAYS refill in an area where you can tolerate a spill. Use a area such as a workbench when refilling.

1. Turn the cartridge upside down, so that you are facing the BOTTOM of the cartridge.
2. Locate the plastic handle plastic TAB on the side of the cartridge. They are sometimes blue in color. The tab is about 1cm x 1cm in size. Depress the TAB. This will unlock the handle.
3. Now you can turn the HANDLE until it exposes a slit opening. Inside this opening is the chamber that holds the toner.
4. Connect the toner pouring nozzle to the toner bottle, and using the funnel provided you can now start pouring toner into the toner cartridge. After you have poured all the toner, you need to close the cartridge by turning the handle in the opposite direction to when you opened it. You need to make sure that you COMPLETELY close the slit-hole opening so that no toner can fall out. You need a tight seal to prevent spillage.

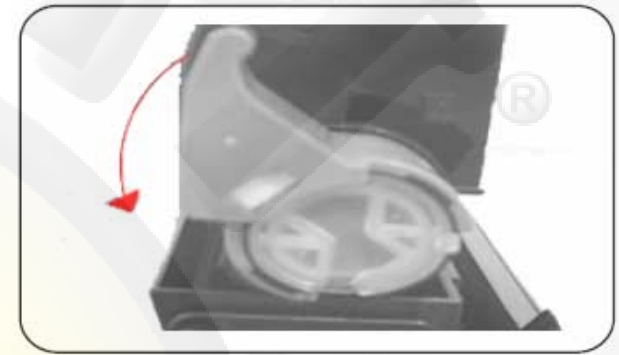

Replacement Cartridge    Starter Cartridge

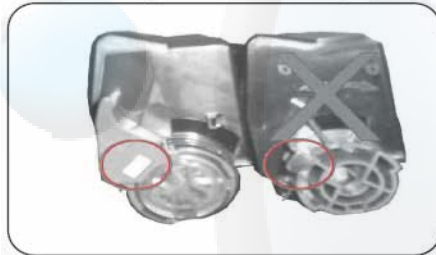

The OKIDATA C5100 cartridges have sensors to detect how much toner is left in the cartridge. Sometimes, this sensor will prevent the refilled cartridge from printing. You can quickly and easily “reset” your cartridge so that the printer recognizes it as a brand new cartridge and allows you to print. First, it is important to note which cartridge you have - is it a “starter cartridge” (the type that come with a new OKI C5100 printer), or is it a “replacement cartridge” (did you buy the cartridge separate to the printer). To identify which cartridge you have, see the picture below

1. Look at your cartridge on the side with the blue handle. Determine which cartridge you have by the tab on the blue handle. If you have a WHITE tab (shown on left) then you just need to wipe this sensor down with a clean paper towel. This sensor needs to be ABSOLUTELY CLEAN in order for the printer to recognize the cartridge. You do not need to use the paper reset method. If you have a SILVER tab (shown on right) then you will need to use the reset method shown below.
2. If you have the starter cartridge you will need to cut a 1.5” X 11” strip of paper. You will use this piece of paper to fool the printer and avoid the “cartridge is empty” message. You have 1 sensor for each color, place this piece of paper between the sensors and the printer as shown in picture above. When you insert the strip of paper the printer will think that you are using the replacement cartridge from the store (not the starter cartridge).



Please be advised that some toner refill kits may be compatible with multiple toner cartridges.



OKIDATA C3400

[CLICK HERE TO GO THE INDEX](#)

#### REQUIRED FOR A SUCCESSFUL REFILL:

- Toner
- 1 funnel cap
- 1 replacement chip
- 1 flat-head screwdriver

Note: Please read carefully before refilling cartridge.

#### General Refilling Procedures:

Using the flat-head screwdriver, press gently on the tab as shown in picture A to release the end-cap and turn (the end-cap) clockwise so that the tab arrives to the second slot as seen in picture B (some remaining or excess toner can and may fall out of the cartridge).

Before opening the bottle of toner, turn it upside down and tap it on a table to loosen the toner and allow it to flow freely. Remove the cap and pull the seal off the bottle. Attach the funnel cap or use a 5mm straw, by making proper adjustments to the bottle cap, to fill the cartridge with toner. If you find it difficult to refill with the funnel cap, you can create another funnel with newspaper or printing paper to help lead the toner into the small opening of the toner hopper. Picture C shows the cartridge being refilled with the 5mm straw. Do not over refill the cartridge, the C3400 can be refilled up to 2 times with the Okidata C5100 universal toner kit and up to 4 times with the Okidata C9000 universal toner kit. Once you have finished refilling the cartridge, work your way backwards thru step A and B to close the toner hopper opening.

After you are finished refilling replace the chip as shown in picture D and F.

A.

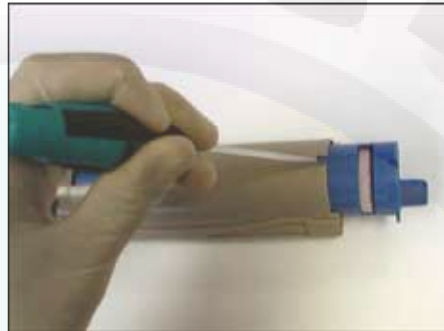

B.



C.



D.

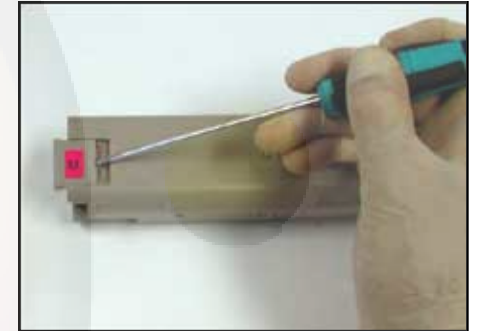

F.

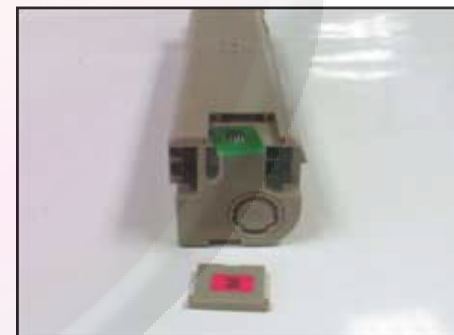

Please be advised that some toner refill kits may be compatible with multiple toner cartridges.



OKIDATA  
C5500 / 5800 / C6100 /  
C8600 / C8800 / C9000

[CLICK HERE TO GO THE INDEX](#)

#### REQUIRED FOR A SUCCESSFUL REFILL:

- Toner
- 1 funnel cap
- 1 replacement chip
- 1 flat-head screwdriver

Note: Please read carefully before refilling cartridge.

#### General Refilling Procedures:

Using the flat-head screwdriver, press gently on the tab as shown in picture A to release the end-cap and turn (the end-cap) clockwise so that the tab arrives to the second slot. (some remaining or excess toner can and may fall out of the cartridge).

**IMPORTANT:** You must dispose of any original toner in the cartridge as much as possible before refilling. Dispose of toner properly into a trash can, or use a vacuum with a hose for best results (if possible).

Before opening the bottle of toner, turn it upside down and tap it on a table to loosen the toner and allow it to flow freely. Remove the cap and pull the seal off the bottle.

Attach the funnel cap or use a 5mm straw, by making proper adjustments to the bottle cap, to fill the cartridge with toner. If you find it difficult to refill with the funnel cap, you can create another funnel with newspaper or printing paper to help lead the toner into the small opening of the toner hopper. Picture B shows the area where the cartridge should be refilled. Do not overfill the cartridge, the C5500 and C5800 can be refilled up to 3 times with the Okidata C9000 universal toner kit. Once you have finished refilling the cartridge, work your way backwards to close the toner hopper opening.

After you are finished refilling replace the chip by removing the cap to the chip holding area. The area can be seen in picture C.

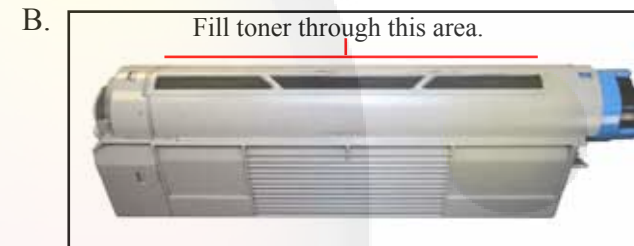
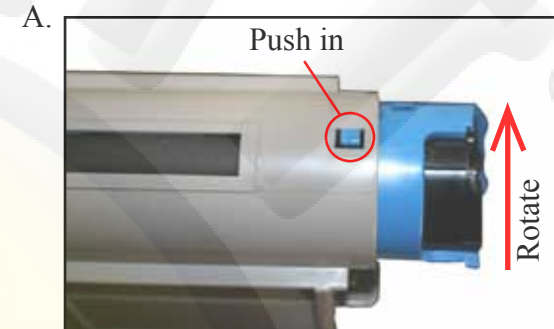





Please be advised that some toner refill kits may be compatible with multiple toner cartridges.

Ricoh CL4000 / SP C410 / C411

[CLICK HERE TO GO THE INDEX](#)

### REQUIRED FOR A SUCCESSFUL REFILL:

- Toner
- 1 funnel cap
- cutting pliers
- Glue

Note: Please read carefully before refilling cartridge.

### General Refilling Procedures:

Make sure you hold this cartridge in an upright position when opening the refill hole (some remaining or excess toner can and may fall out of the cartridge). Slide the small cover door, shown in picture B, to the left gently. Please be careful not to slide this small door off the track (it can be quite difficult to replace).

Before opening the bottle of toner, turn it upside down and tap it on a table to loosen the toner and allow it to flow freely. Remove the cap and pull the seal off the bottle. Attach the funnel cap making to sure it is on tightly. Tilt the cartridge at a 45 degree angle and then the funnel cap toward the filling hole and insert it into the hole. If the toner stops flowing before the cartridge is full, simply remove the toner, close the cap, turn the bottle upside down and tap it on a table. If the funnel cap you are provided is much larger than the opening of the refill hole, you can use plain paper or news paper as an alternative assistant to help guide the toner directly into the hole. When you are done refilling this cartridge, slide the small door back to its original position, so that the hole is no longer exposed.

You can now place your cartridge back into your printer as shown in picture A.

**NOTE:** If picture A looks different than your printer, please set colors according to your printer.

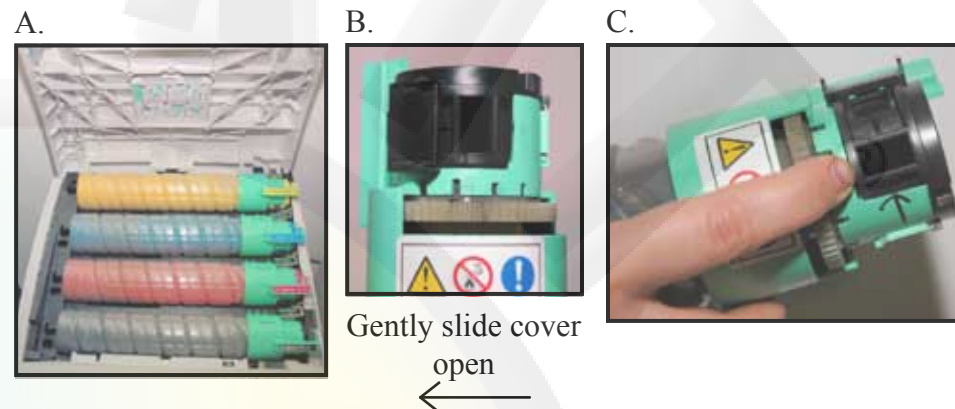

### How to replace the chip

NESTED OEM

NESTED COMPATIBLE

**IMPORTANT: DO NOT GET GLUE NEAR OR ON THE CONTACTS**

With some pliers, clip off the tab closest to the edge of the cartridge. Remove the OEM chip from the cartridge and ensure the tab surface is smooth and level. Slide the replacement chip into place (The chip should slide comfortably under the notch that was not removed). With a hot glue gun, or crazy glue, hold the chip and glue the end of it as shown in the illustration above (Nested Compatible). Do not get any glue near or on the contacts of the chip as it can cause damage to the chip. Very small amounts of glue will do, and will also be make removing the chip easy on your next refill.

Please be advised that some toner refill kits may be compatible with multiple toner cartridges.



RICOH CL7000 / CL7200

[CLICK HERE TO GO THE INDEX](#)

**REQUIRED FOR A SUCCESSFUL REFILL:**

- Toner
- 1 funnel cap
- 1 replacement chip

Note: Please read carefully before refilling cartridge.

***General Refilling Procedures:***

Before opening the bottle of toner, turn it upside down and tap it on a table to loosen the toner and allow it to flow freely. Remove the cap and pull the seal off the bottle.

Attach the funnel cap or use a 5mm straw, by making proper adjustments to the bottle cap, to fill the cartridge with toner. If you find it difficult to refill with the funnel cap, you can create another funnel with newspaper or printing paper to help lead the toner into the small opening of the toner hopper. The picture on the right shows the area where the cartridge should be refilled.

After you are finished refilling, replace the chip (if needed) located on the opposite end of the refilling hole. Your cartridge is now ready for use.



Please be advised that some toner refill kits may be compatible with multiple toner cartridges.



RICOH CL3500

[CLICK HERE TO GO THE INDEX](#)

#### REQUIRED FOR A SUCCESSFUL REFILL:

- Toner
- 1 funnel

#### General Refilling Procedures:

Use a flathead screwdriver to carefully pop out the large plastic plug found on the side of the side of the cartridge.

***IMPORTANT: If any toner is inside the cartridge before refilling, please dispose of it properly (example: trash can). For best results, try disposing as much of the OEM toner as possible, or try using as much of it so that it doesn't go to waste.***

Before opening the bottle of toner, turn it upside down and tap it on a table to loosen the toner and allow it to flow freely. Remove the cap and pull the seal off the bottle. Attach the funnel cap making sure it is on tightly. Tilt the funnel cap toward the filling hole and begin to fill. If the toner stops flowing before the cartridge is full, simply remove the toner, close the cap, turn the bottle upside down and tap it on a table. Once the cartridge is full, seal the hole with the plug by twisting it until it is completely seated. Now gently shake the cartridge side to side to distribute the toner.



Remove plug carefully and Refill here





Please be advised that some toner refill kits may be compatible with multiple toner cartridges.

Samsung – ML 1710

[CLICK HERE TO GO THE INDEX](#)



#### REQUIRED FOR A SUCCESSFUL REFILL:

- Toner
- 1 funnel cap

#### *General Refilling Procedures:*

Use a flathead screwdriver to pop out the large plastic plug found on the side of the side of the cartridge.

Before opening the bottle of toner, turn it upside down and tap it on a table to loosen the toner and allow it to flow freely. Remove the cap and pull the seal off the bottle. Attach the funnel cap making sure it is on tightly. Tilt the funnel cap toward the filling hole and insert it into the hole. If the toner stops flowing before the cartridge is full, simply remove the toner, close the cap, turn the bottle upside down and tap it on a table. Once the cartridge is full, seal the hole with the plug by twisting it until it is completely seated. Now gently shake the cartridge side to side to distribute the toner.

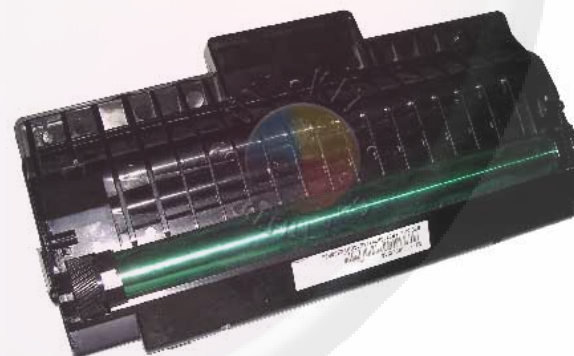

Please be advised that some toner refill kits may be compatible with multiple toner cartridges.



Samsung – SF5100 / TDR510P / ML4500 /  
ML1210  
Lexmark – 10S0150

[CLICK HERE TO GO THE INDEX](#)

#### REQUIRED FOR A SUCCESSFUL REFILL:

- Toner
- 1 funnel cap
- Replacement fuse or chip

#### General Refilling Procedures:

Follow step A for cartridge that have the plug located on the side then proceed to step C:

**A.** Use a flathead screwdriver to pop out the large plastic plug found on the side of the side of the cartridge.

Follow step B for cartridges that DO NOT have a plug on the side then proceed to step C:

**NOTE:** The Hole Making Tool is Required for this step.

**B.** Rest the Hole Making Tool on its stand and plug into an outlet. Wait 3 full minutes before using. Position the copper bit on the cartridge in the spot indicated by the photograph and push gently until it melts a hole in the cartridge. Make sure to keep the hole on the flat surface of the cartridge and not on the curved edge. Remove the tool, place it back on its stand and unplug it. If the small piece of plastic has fallen into the cartridge, it must be removed, as this can damage your cartridge or cause print defects. If the piece remains in the tool, wait for the tool to cool down and pry it out.

**C.** Before opening the bottle of toner, turn it upside down and tap it on a table to loosen the toner and allow it to flow freely. Remove the cap and pull the seal off the bottle. Attach the funnel cap making to sure it is on tightly. Tilt the funnel cap toward the filling hole and insert it into the hole. If the toner stops flowing before the cartridge is full, simply remove the toner, close the cap, turn the bottle upside down and tap it on a table. Once the cartridge is full, seal the hole with the plug by twisting it until it is completely seated. Now gently shake the cartridge side to side to distribute the toner.

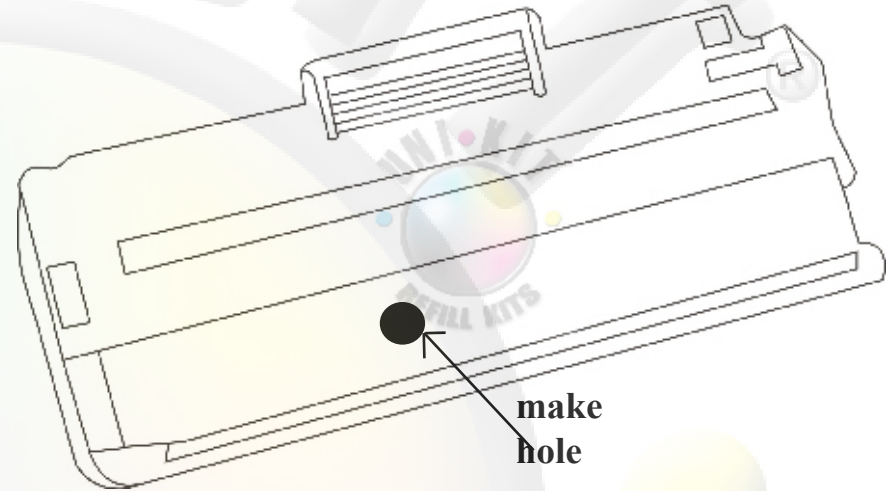

#### Replacing the Chip (Lexmark):

To replace the chip simply use a flathead screwdriver and pry off the chip and replace with the new peel and stick chip.

#### Replacing the Fuse (Samsung):

Some versions of the cartridge have a small band of plastic or metal holding the fuse in place. Other versions have a small bit of adhesive holding it in place.

If you cartridge has the small band, simply unscrew the strip and place the new fuse in place and reattach the plastic or metal strip.

If you fuse was held in place by adhesive, we recommend using a small piece of duct tape to hold the fuse to the cartridge.

**NOTE:** If you are using the duct tape, make sure that it only covers the glass part of the fuse and is NOT touching the metal part of the fuse.



Please be advised that some toner refill kits may be compatible with multiple toner cartridges.

Samsung CLP600

[CLICK HERE TO GO THE INDEX](#)

**REQUIRED FOR A SUCCESSFUL REFILL:**

- Toner
- 1 funnel cap

**General Refilling Procedures:**

1. To split the cartridge into two sections, remove the two housing pins. These two pins have an internal thread, so a simple screw can be gently inserted and pulled to remove each pin.



Remove Plug and Refill Here

2. After splitting the cartridge into 2, you will notice the filling hole as in the picture below. The filling hole has a round sealing cap, remove this cap to refill the cartridge, then replace the cap after it has been refilled.



***IMPORTANT: You must dispose of any original toner in the cartridge as much as possible before refilling. Dispose of toner properly into a trash can, or use a vacuum with a hose for best results (if possible).***

3. Replace the original chip (as shown below) with the replacement chip.

**OEM CHIP REPLACEMENT**

Just prior to joining the drum unit and toner hopper, you must replace the OEM chip located at the rear of the drum unit. Using a small flat head screwdriver, pry the chip upward as shown.

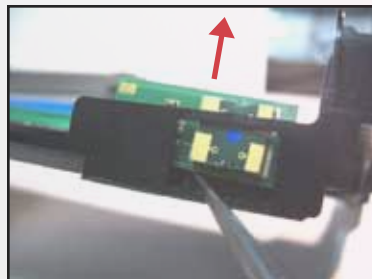

Remove the OEM chip and replace it with a new aftermarket one. Join the cartridge halves and test the cartridge.







Please be advised that some toner refill kits may be compatible with multiple toner cartridges.

Samsung CLP610 / CLP 660

[CLICK HERE TO GO THE INDEX](#)

### REQUIRED FOR A SUCCESSFUL REFILL:

- Toner
- 1 funnel cap
- Replacement Chip

Follow the picture illustrations that follow to pull apart the two halves of your cartridge. This will provide you with access to the toner hopper to refill the cartridge and the chip that will need to be replaced



Carefully remove the spring in the image above.



Carefully remove the second spring in the image above.

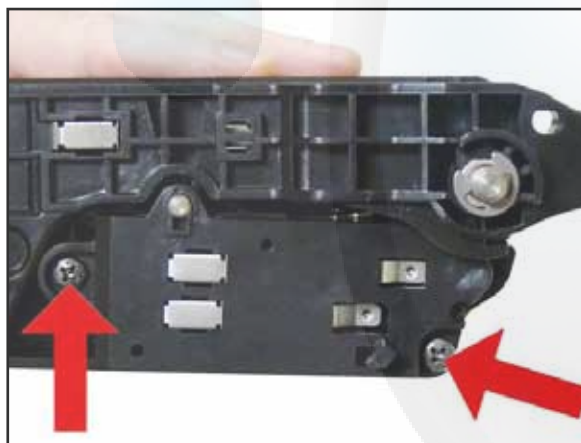

Remove screws holding down the contact plate.



Do not fully remove the contact plate. The pin in the picture above must first be removed, before the contact plate can be removed



Remove pin on the other side of the cartridge.

*Continue on next page...*

© All rights reserved, Easy Group, LLC. Version 6.0

All trademarks are property of their respective owners. Uni-Kit® has no association with any of the manufacturers listed here such as Hp, Epson, Lexmark, Xerox, etc. All logos and brand names shown here are used for identification purposes only. It is illegal to reproduce these instructions without written licensing consent from Easy Group LLC.



Please be advised that some toner refill kits may be compatible with multiple toner cartridges.

Samsung CLP610 / CLP 660

[CLICK HERE TO GO THE INDEX](#)

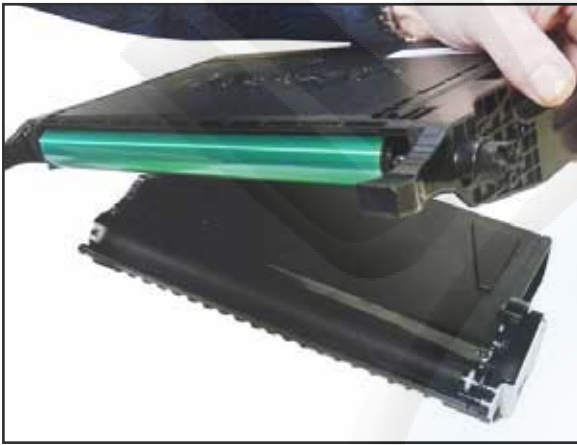

Pull apart the two halves of the cartridge.



Remove the toner hopper plug, dump out and discard of any old toner before refilling with new toner.

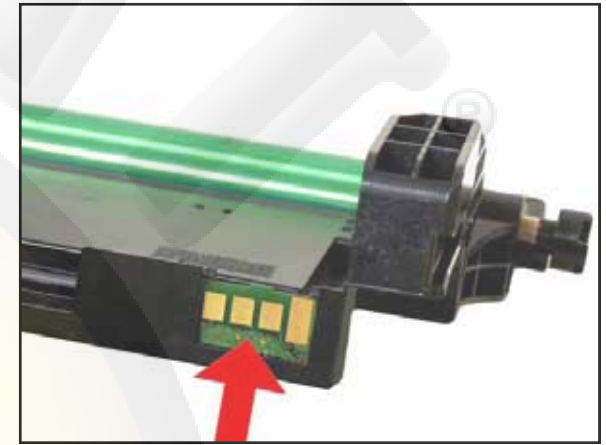

Remove the old chip, and replace it with the a new uni-kit replacement smartchip. After the chip is replaced, you may reverse the process to put the cartridge back together.

Please be advised that some toner refill kits may be compatible with multiple toner cartridges.



XEROX TEKTRONIX PHASER 6100 / SAMSUNG CLP 500

[CLICK HERE TO GO THE INDEX](#)

1. Remove the 4 screws from the top of the cartridge.
3. Carefully spread the sides of the cartridge cover to release the catches on both sides of the bottom. A small flat-bladed screwdriver may be used, but be careful not to break the plastic.

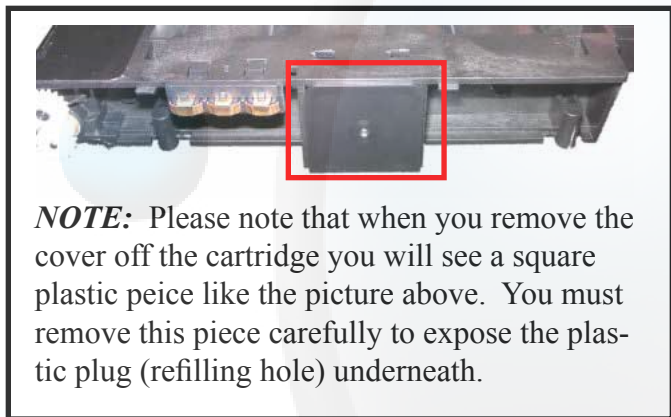

**NOTE:** Please note that when you remove the cover off the cartridge you will see a square plastic piece like the picture above. You must remove this piece carefully to expose the plastic plug (refilling hole) underneath.

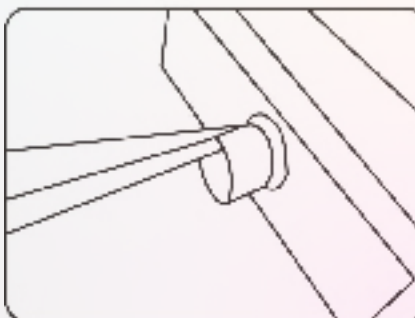
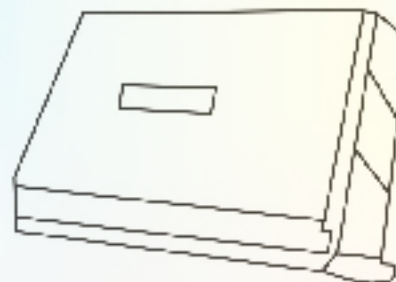
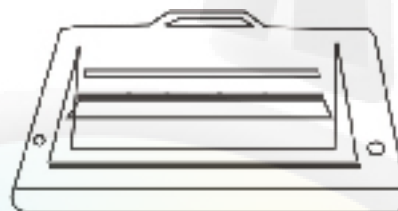

2. Remove one screw from the side of the cartridge
4. The cover should lift straight up and off. Be gentle and slow as there may be a small amount of glue on the front edge of the plastic. You should now have something resembling the cartridge pictured above.
5. Remove the plastic plug in the side of the cartridge with a small pair of pliers. Pull on alternate sides until the plugs come out.
6. Carefully pour in the new toner. Cleanup any spills or clothing with cold water. Replace the plug, cover and screws in reverse order.

**GENERAL COMMENTS:**

(The Pictures show refilling a high capacity black cartridge. The standard capacity color cartridges are identical except the center section of the cartridge is not raised). If there is no pull out plug in the area indicated on your cartridge. You will require a hole making tool to create the refill hole in same location we indicate their should be a plug.

*Please Continue to Next Page for Chip Installation Instructions*

© All rights reserved, Easy Group, LLC. Version 6.0

All trademarks are property of their respective owners. Uni-Kit® has no association with any of the manufacturers listed here such as Hp, Epson, Lexmark, Xerox, etc. All logos and brand names shown here are used for identification purposes only. It is illegal to reproduce these instructions without written licensing consent from Easy Group LLC.



Please be advised that some toner refill kits may be compatible with multiple toner cartridges.



XEROX TEKTRONIX PHASER 6100 / SAMSUNG CLP 500

[CLICK HERE TO GO THE INDEX](#)

CLP 510 Smartchip Replacement Instructions

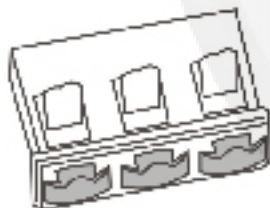
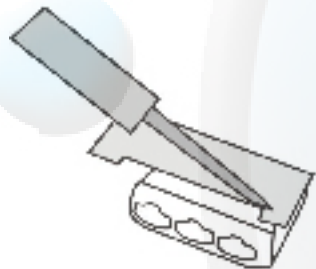
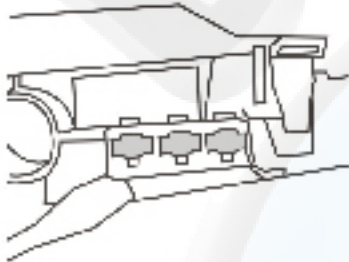
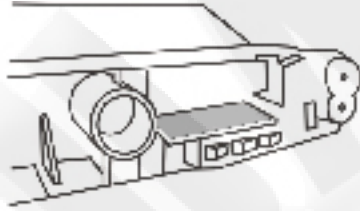

Locate the chip next to the filling plug (as per refilling instructions). To get to this chip you need to remove 3 or 4 screws from the top of the cartridge, and 1 screw on the side of the cartridge. Then remove the “cap” of the cartridge. These instructions are detailed in the ‘REFILL INSTRUCTIONS’ for CLP510. You will notice the chip that needs to be replaced is located RIGHT NEXT to the filling hole.

Gently remove the chip by using a small Flathead screwdriver. You will notice on the bottom of the chip that there are 2 plastic square connectors that are about 0.5mm x 0.5mm. If you gently push those towards you (towards the outside of the cartridge) this will make removing the chip easier.

Using a soldering iron, slowly de-solder the original smart chip from the black connector below it. There are 3 parts that need to be de-soldered. BE CAREFUL NOT TO BURN YOURSELF and be careful that you do not damage the connector.

Now that you have removed the chip, you are left with a plain connector. Now you can solder the NEW replacement smart chip onto this connector by using some soldering iron. When the new chip is in place on the connector, put the connector back onto the cartridge and replace the cover of the cartridge.

### **Troubleshooting:**

If the printer gives you an error message after you have installed the chip like “incorrect toner” or “invalid toner” or any other error message, then you need to SWITCH OFF the printer, wait a few seconds, then switch it back ON and hold down the MENU button while you are powering it back on.

If your printer will only allow you to print in black only mode, then go to your printer settings, click on PROPERTIES and then restore to printer defaults.

Please be advised that some toner refill kits may be compatible with multiple toner cartridges.



Samsung CLP300 / Xerox 6110

[CLICK HERE TO GO THE INDEX](#)

#### REQUIRED FOR A SUCCESSFUL REFILL:

- Toner
- 1 hole making tool
- 1 replacement chip

Note: Please read carefully before refilling cartridge.

#### General Refilling Procedures:

Make sure you hold this cartridge in an upright position before creating a refill hole (some remaining or excess toner can and may fall out of the cartridge). Illustration A on the right shows you where to create a refill hole for your cartridge. Once the hole has been created, empty any toner left inside the cartridge (mixing two different brands of toners could result in bad printing, or rare discoloration in your prints).

Before opening the bottle of toner, turn it upside down and tap it on a table to loosen the toner and allow it to flow freely. Remove the cap and pull the seal off the bottle. Attach the funnel cap making to sure it is on tightly. Tilt the cartridge at a 45 degree angle and then the funnel cap toward the filling hole and insert it into the hole. If the toner stops flowing before the cartridge is full, simply remove the toner, close the cap, turn the bottle upside down and tap it on a table. When you are done refilling this cartridge, simply use duct tape, or electrical tape to seal the refilling hole back up. Please use illustration B as a guidance.

Next, you will need to replace the chip. Please follow the diagram to the right for chip installation instructions. Once you have finished installing the chip, you may now place your cartridge back into the printer

A.



B.



Do NOT attempt to remove the OEM chip as it is fused into the cartridge. We will simply place the ultra-thin replacement chip over the original.



Peel off the strip (shown) to expose the adhesive backing on the reverse side of the chip.

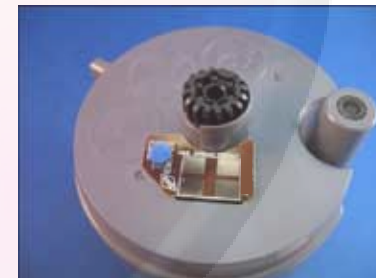

Apply the new chip over the OEM as shown.

Please be advised that some toner refill kits may be compatible with multiple toner cartridges.



### REQUIRED FOR A SUCCESSFUL REFILL:

- Toner refill kit
- 1 Phillips screwdriver and flat head screw driver
- Needle nose pliers

Note: Please read carefully before refilling cartridge.

### General Refilling Procedures:

Remove toner hopper plug and empty any toner left inside the cartridge (mixing two different brands of toners could result in bad printing, or rare discoloration in your prints).

Before opening the bottle of toner, turn it upside down and tap it on a table to loosen the toner and allow it to flow freely. Remove the cap and pull the seal off the bottle. Attach the funnel cap making sure it is on tightly. Tilt the cartridge at a 45 degree angle and then the funnel cap toward the filling hole and insert it into the hole. If the toner stops flowing before the cartridge is full, simply remove the toner, close the cap, turn the bottle upside down and tap it on a table. Once you are done refilling this cartridge, place the sealing plug back in its place and use duct tape or electrical tape to seal up any necessary cracks on the plug.

The cartridge is now ready for use.

### SCX-D4200A Instructions

Follow illustrations 1-5 on the right to refill the SCX-D4200A cartridge. Once you have removed the top portion of the cartridge, as shown on illustration 4, you will be allowed to change the OEM chip with the Uni-kit chip provided.

SAMSUNG ML-1510,  
ML-2250, SCX-D4200A

[CLICK HERE TO GO THE INDEX](#)

### 1. D4200A Instructions

Refill Hole

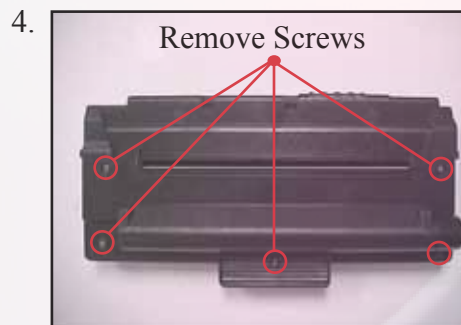

Refill in this area



Please be advised that some toner refill kits may be compatible with multiple toner cartridges.



Samsung ML-7000

Page 1 of 2

[CLICK HERE TO GO THE INDEX](#)

### REQUIRED FOR A SUCCESSFUL REFILL:

- Toner
- 1 funnel cap
- 1 Flathead screwdriver
- 1 Phillips screwdriver

Note: Please read carefully before refilling cartridge.

### General Refilling Procedures:

1. Clean the exterior of the cartridge.
2. Place the cartridge with the toner hopper away from you. Remove the Drum cover by unsnapping the bar from both the right and left sides of the cartridge. Note the cover spring orientation for when it is re-installed. See Figure's A & B. (The spring has been colorized to better show its position).
3. Un-hook the small springs from both sides of the toner hopper. See Figure C.
4. On the right side, remove the two screws from the end cap. Re move the end cap. See Figure D.
5. Remove the entire waste section by working the left end cap free from the hopper. It is just held on by pressure. See Figure E.
6. Remove the two screws and plastic bushing from the right side end cap. See Figure F.

Instructions Continue on next page...

Figure A.

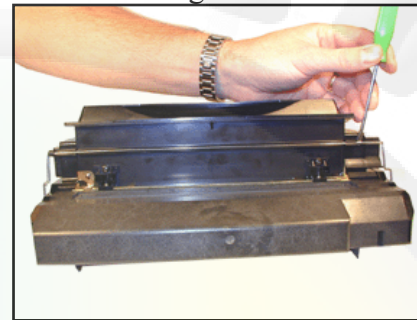

Figure B

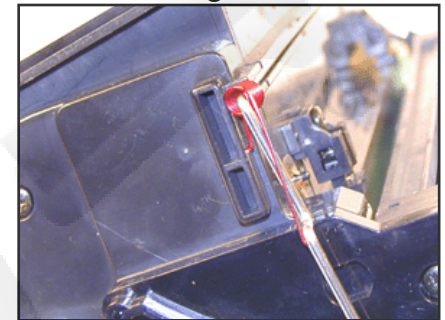

Figure C.



Figure D.

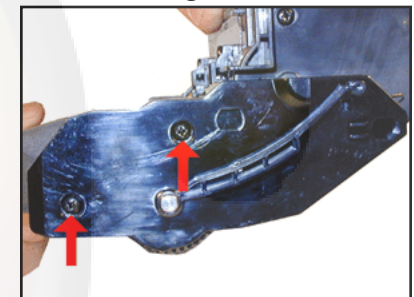

Figure E.

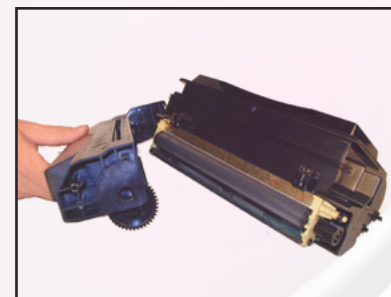
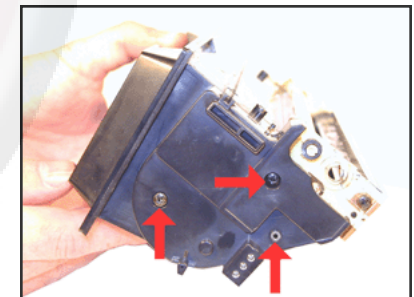

Figure F.



Please be advised that some toner refill kits may be compatible with multiple toner cartridges.



Samsung ML-7000

Page 2 of 2

[CLICK HERE TO GO THE INDEX](#)

7. Remove the optical sensor, un-hook the wires, and remove the end cap. See Figure's G & H.

8. This cartridge uses a unique but very simple toner sensing system. The clear LED sends a light through the clear plastic slot it fits into. The optical sensor doesn't see the light as long as toner is in between them. As soon as the toner gets low, the sensor picks up the light and signals "Toner Low".

9. Remove the fill plug from the hopper. This plug is very easy to damage as it is made of hard plastic. We have found the best way is to use a fixed razor knife to get under the lip, and work it loose. You can also use a flat head screwdriver to loosen the cap. (TAKE EXTREME CAUTION WHEN USING EITHER OBJECT TO REMOVE THE PLUG). If the lip gets damaged, put a small amount of silicon around it when you replace the plug. See Figure's I & J.

10. Re-assemble the cartridge and place back into printer for testing.

Figure G.

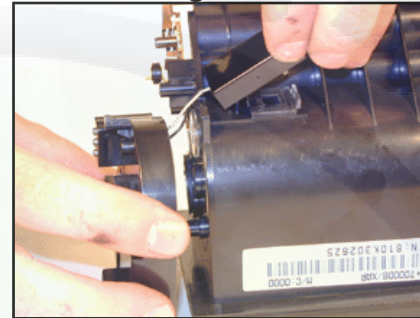

Figure H

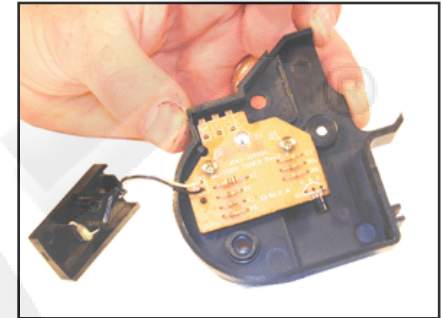

Figure I.

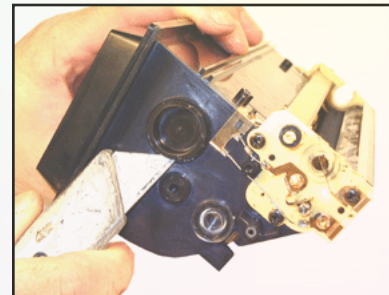

Figure J.



Please be advised that some toner refill kits may be compatible with multiple toner cartridges.



SAMSUNG 3050 / 2850 / 2851 / 4826

[CLICK HERE TO GO THE INDEX](#)

#### REQUIRED FOR A SUCCESSFUL REFILL:

- Toner
- 1 funnel cap

#### General Refilling Procedures:

Using the screw driver, remove the screws on the side of the cartridge so that the sealing plug can be revealed (Illustration A,B, & C.). Once you have located the sealing plug, use the flat head screw driver to gently loosen the sealing plug(Illustration D.). With the needle nose pliers, gently, but forcefully pull the plug completely off the cartridge. If the plug happens to bent or crack, you may use electrical tape or duct tape to securely seal the cracks or bents once you have replaced the plug at the end of the refill process.

**IMPORTANT: You must dispose of any original toner in the cartridge as much as possible before refilling. Dispose of toner properly into a trash can.**

Before opening the bottle of toner, turn it upside down and tap it on a table to loosen the toner and allow it to flow freely. Remove the cap and pull the seal off the bottle. Attach the funnel cap making sure it is on tightly. Tilt the funnel cap toward the filling hole and insert it into the hole. If the toner stops flowing before the cartridge is full, simply remove the toner, close the cap, turn the bottle upside down and tap it on a table. Once the cartridge is full seal the hole with the plug.

Replace the chip by following the directions on illustration E. Once you have finished replacing the chip, gently shake the cartridge side to side to distribute the toner.



A. Remove the 3 screws on the right end cap.



B. Gently pry off plastic drum axle bushing. Keep this



C. On the top edge of the end cap, there is a plastic tab. Press in on the tab and remove the right end cap.



D. Remove plug (circled in red) and remove any remaining toner before refilling.



E. Replace the chip by cutting the plastic rivets, drilling two holes, and setting two self tapping screws in place.



Please be advised that some toner refill kits may be compatible with multiple toner cartridges.



SAMSUNG ML2150 / ML2151 / ML2152 /  
ML2155 / ML2151N / ML2152W / ML2550 /  
ML2551N / ML2552W

[CLICK HERE TO GO THE INDEX](#)

#### REQUIRED FOR A SUCCESSFUL REFILL:

- Toner
- 1 funnel cap
- Screw Driver

#### General Refilling Procedures:

Using a screwdriver, remove the screws as illustrated on the first top picture to the right. Please do this in an open ventilated area (Outside would be best). Toner may spill, please use care in removing the top portion of the cartridge.

**IMPORTANT: You must dispose of any original toner in the cartridge as much as possible before refilling. Dispose of toner properly into a trash can. Do not overfill the cartridge by pouring the entire toner powder into the cartridge. Use half the bottle now, and the rest at a later time. Overfilling can and will damage a cartridge.**

Before opening the bottle of toner, turn it upside down and tap it on a table to loosen the toner and allow it to flow freely. Remove the cap and pull the seal off the bottle. Attach the funnel cap making to sure it is on tightly. Tilt the funnel cap toward the toner hopper and fill the hopper. If the toner stops flowing before the cartridge is full, simply remove the toner, close the cap, turn the bottle upside down and tap it on a table. Once the cartridge has enough toner, place the removed portion back into place and screw it in.

Once everything has been reassembled, replace the chip by removing the screw (see illustration to the right). Once the chip has been replaced, shake the cartridge side to side to distribute the toner.



Please be advised that some toner refill kits may be compatible with multiple toner cartridges.



Samsung CLP310 - 315 / Dell 1230

[CLICK HERE TO GO THE INDEX](#)

#### REQUIRED FOR A SUCCESSFUL REFILL:

- Toner
- Needle nose pliers and small flat head screwdriver

Note: Please read carefully before refilling cartridge.

#### General Refilling Procedures:

Make sure you hold this cartridge in an upright position before refilling (some remaining or excess toner can and may fall out of the cartridge). The illustration on the right shows you where to find the refill plug on your cartridge. Once you have located the plug and removed it, empty any toner left inside the cartridge (*mixing two different brands of toners could result in bad printing, or rare discoloration in your prints*).

**IMPORTANT:** You must dispose of any original toner in the cartridge as much as possible before refilling. Dispose of toner properly into a trash can. Do not overfill the cartridge by pouring the entire toner powder into the cartridge. Use half the bottle now, and the rest at a later time. Overfilling can and will damage a cartridge.

Before opening the bottle of toner, turn it upside down and tap it on a table to loosen the toner and allow it to flow freely. Remove the cap and pull the seal off the bottle. Attach the funnel cap making to sure it is on tightly. Tilt the cartridge at a 45 degree angle and then the funnel cap toward the filling hole and insert it into the hole. If the toner stops flowing before the cartridge is full, simply remove the toner, close the cap, turn the bottle upside down and tap it on a table. When you are done refilling this cartridge, simply replace the plug on the cartridge as it was before refilling.

**Note:** Printers using this cartridge model will work without a chip replacement or chip reset. Please be sure to refill the cartridge when the ink status shows 25% of the toner is left in the cartridge



Remove Plastic Cover

Carefully Remove Plastic Plug

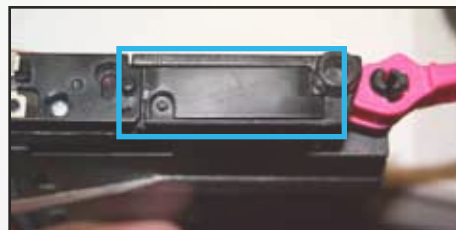

#### Installing your new chip

To install the new chip, the chip holder on the cartridge must be slightly modified. The area in red to the right shows where the modification must be made. Simply cut the portion off, slide out the old chip, and install the new chip. You may use some hot glue if needed on the top tips of the chip.



Please be advised that some toner refill kits may be compatible with multiple toner cartridges.



Samsung ML1630 / SCX-4500

[CLICK HERE TO GO THE INDEX](#)

#### REQUIRED FOR A SUCCESSFUL REFILL:

- Toner
- Needle nose pliers and small flat head screwdriver

Note: Please read carefully before refilling cartridge.

#### General Refilling Procedures:

Remove the screws from the side panel which hold it in place. After the screw have been removed, remove the side panel from the cartridge. You will now see a plug that looks like the picture on the right. Remove this plug and dispose of the old toner before refilling it with the new toner.

**IMPORTANT:** You must dispose of any original toner in the cartridge as much as possible before refilling. Dispose of toner properly into a trash can . Do not overfill the cartridge by pouring the entire toner powder into the cartridge. Use half the bottle now, and the rest at a later time. Overfilling can and will damage a cartridge.

Before opening the bottle of toner, turn it upside down and tap it on a table to loosen the toner and allow it to flow freely. Remove the cap and pull the seal off the bottle. Attach the funnel cap making to sure it is on tightly. Tilt the cartridge at a 45 degree angle and then the funnel cap toward the filling hole and insert it into the hole. If the toner stops flowing before the cartridge is full, simply remove the toner, close the cap, turn the bottle upside down and tap it on a table. When you are done refilling this cartridge, simply replace the plug on the cartridge as it was before refilling.

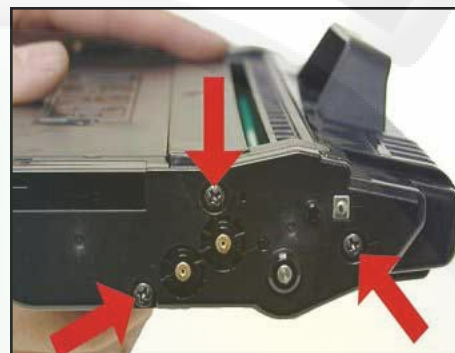

Remove screws from side cap.



Carefully remove Toner Plug.



To replace the chip, drill out the two plastic rivets using a 5/64 bit and replace them with screws after the chip has been changed.



Please be advised that some toner refill kits may be compatible with multiple toner cartridges.



[CLICK HERE TO GO THE INDEX](#)

SHARP FO45ND  
RICOH 339479  
RICOH 339473  
PITNEY BOWES 8186,  
MURATEC/MURATA TS120  
OKIDATA 52111401  
NEC 20090  
NEC S2526  
MINOLTA 4161101, 1710434001  
MINOLTA 1710433001, 0938306

**REQUIRED FOR A SUCCESSFUL REFILL:**

- Toner
- 1 funnel cap

***General Refilling Procedures:***

- 1 Remove the plug from the side of the cartridge by using a screwdriver, thereby exposing the fill hole.
- 2 Refill by pouring toner into the fill hole through the nozzle attached to the toner bottle.
3. Replace the plug when finished refilling.



Please be advised that some toner refill kits may be compatible with multiple toner cartridges.



Sharp ZT20TD1

[CLICK HERE TO GO THE INDEX](#)

#### REQUIRED FOR A SUCCESSFUL REFILL:

- Toner
- 1 funnel cap
- 1 hole plug
- Toner Hole Making Tool

#### *General Refilling Procedures:*

1. First you need to remove the END CAP of this cartridge by removing the screws from the side.
2. Slowly and gently, pull the END CAP out and to the right until you notice that the “locking tab” has been released (this will make it easier for you to completely remove the END CAP).
3. Underneath the END CAP you will notice a plug, remove this plug using a screw-driver – this reveals the filling hole.
4. Refill by pouring toner into the fill hole through the nozzle attached to the toner bottle.
5. Replace the plug when finished refilling, and replace the end cap making sure the pins line up correctly.

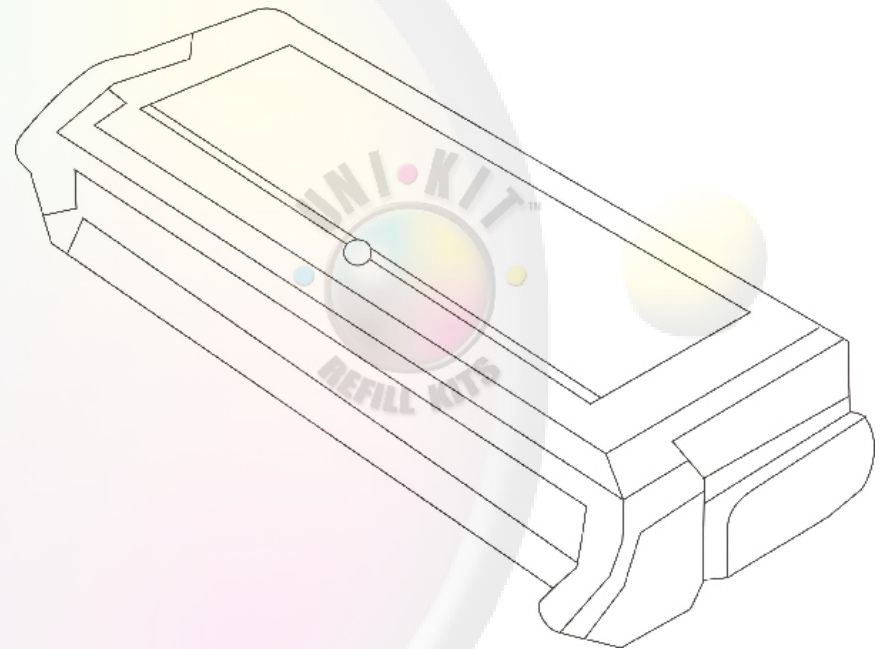

Please be advised that some toner refill kits may be compatible with multiple toner cartridges.



XEROX 6R916 / 9R917

[CLICK HERE TO GO THE INDEX](#)

#### REQUIRED FOR A SUCCESSFUL REFILL:

- Toner
- 1 funnel cap

#### *General Refilling Procedures:*

1. First you need to locate the plastic SEALING PLUG similar to the one shown in this diagram.
2. Slowly and gently, pry the SEALING PLUG away from the cartridge using a flat screwdriver - this reveals the filling hole.
3. Refill by pouring toner into the fill hole through the nozzle attached to the toner bottle.
4. Replace the plug when finished refilling.





Please be advised that some toner refill kits may be compatible with multiple toner cartridges.



Xerox - 6R899

[CLICK HERE TO GO THE INDEX](#)

#### REQUIRED FOR A SUCCESSFUL REFILL:

- Toner
- 1 funnel cap
- 1 hole plug
- Toner Hole Making Tool

#### *General Refilling Procedures:*

Rest the Hole Making Tool on its stand and plug into an outlet. Wait 3 full minutes before using. Position the copper bit on the cartridge in the spot indicated by the photograph and push gently until it melts a hole in the cartridge. Remove the tool, place it back on its stand and unplug it. If the small piece of plastic has fallen into the cartridge, it must be removed, as this can damage your cartridge or cause print defects. If the piece remains in the tool, wait for the tool to cool down and pry it out.

Before opening the bottle of toner, turn it upside down and tap it on a table to loosen the toner and allow it to flow freely. Remove the cap and pull the seal off the bottle. Attach the funnel cap making sure it is on tightly. Tilt the funnel cap toward the filling hole and insert it into the hole. If the toner stops flowing before the cartridge is full, simply remove the toner, close the cap, turn the bottle upside down and tap it on a table. Once the cartridge is full seal the hole with the plug.

Do not press down on the plug since the cartridge is resting on a table this can actually damage the photo-optic drum. Instead hold one end of the cartridge up off the table and twist the plug until it fully sealed. Now gently shake the cartridge side to side to distribute the toner.

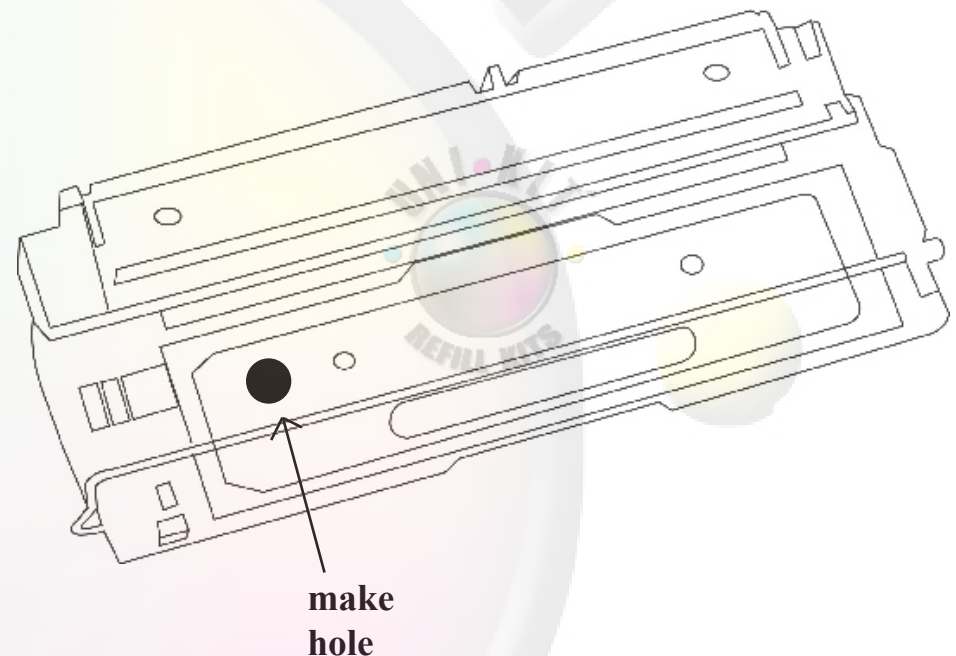

Please be advised that some toner refill kits may be compatible with multiple toner cartridges.



[CLICK HERE TO GO THE INDEX](#)

XEROX 6R359  
6R343, 6R333, 6R881, 6R737,  
SHARP Z781701, ZT50701

#### REQUIRED FOR A SUCCESSFUL REFILL:

- Toner
- 1 funnel cap
- 1 hole plug
- Toner Hole Making Tool

#### General Refilling Procedures:

1. First you need to remove the END CAP of this cartridge by removing the screws from the side.
2. Slowly and gently, pull the END CAP out and to the right until you notice that the "locking tab" has been released (this will make it easier for you to completely remove the END CAP).
3. Underneath the END CAP you will notice a plug, remove this plug using a screwdriver – this reveals the filling hole.
4. Refill by pouring toner into the fill hole through the nozzle attached to the toner bottle.
5. Replace the plug when finished refilling, and replace the end cap making sure the pins line up correctly.

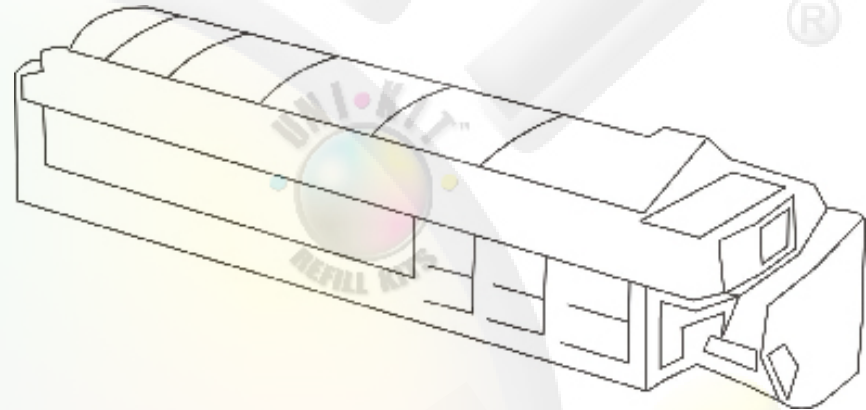

Please be advised that some toner refill kits may be compatible with multiple toner cartridges.



[CLICK HERE TO GO THE INDEX](#)

Xerox - 106R441/106R442  
Samsung - ML6060  
NEC - 20152  
Minolta - 1710497001

#### REQUIRED FOR A SUCCESSFUL REFILL:

- Toner
- 1 funnel cap
- 1 hole plug
- Toner Hole Making Tool

#### *General Refilling Procedures:*

Rest the Hole Making Tool on its stand and plug into an outlet. Wait 3 full minutes before using. Position the copper bit on the cartridge in the spot indicated by the photograph and push gently until it melts a hole in the cartridge. Remove the tool, place it back on its stand and unplug it. If the small piece of plastic has fallen into the cartridge, it must be removed, as this can damage your cartridge or cause print defects. If the piece remains in the tool, wait for the tool to cool down and pry it out.

Before opening the bottle of toner, turn it upside down and tap it on a table to loosen the toner and allow it to flow freely. Remove the cap and pull the seal off the bottle. Attach the funnel cap making to sure it is on tightly. Tilt the funnel cap toward the filling hole and insert it into the hole. If the toner stops flowing before the cartridge is full, simply remove the toner, close the cap, turn the bottle upside down and tap it on a table. Once the cartridge is full seal the hole with the plug.

Do not press down on the plug since the cartridge is resting on a table this can actually damage the photo-optic drum. Instead hold one end of the cartridge up off the table and twist the plug until it fully sealed. Now gently shake the cartridge side to side to distribute the toner.





Please be advised that some toner refill kits may be compatible with multiple toner cartridges.



Xerox – 6R914  
Sharp – AL100TD

[CLICK HERE TO GO THE INDEX](#)

#### REQUIRED FOR A SUCCESSFUL REFILL:

- Toner
- 1 funnel cap

#### General Refilling Procedures:

Use a screwdriver to remove the small screws holding the end cap in place. The locking tabs will unlock when you gently pry the off the end cap You will now see a large plastic plug. Use a flathead screwdriver to pop out the large plastic plug found on the side of the side of the cartridge.

Before opening the bottle of toner, turn it upside down and tap it on a table to loosen the toner and allow it to flow freely. Remove the cap and pull the seal off the bottle. Attach the funnel cap making to sure it is on tightly. Tilt the funnel cap toward the filling hole and insert it into the hole. If the toner stops flowing before the cartridge is full, simply remove the toner, close the cap, turn the bottle upside down and tap it on a table. Once the cartridge is full, seal the hole with the plug by twisting it until it is completely seated. Now gently shake the cartridge side to side to distribute the toner.

#### DEVELOPER NOTE:

Adding developer onto your cartridge's magnetic roller is similar to pouring mustard on a hotdog. Applying less developer is better than applying too much developer.

Pour a thin bead of developer across the length of the magnetic roller.  
Rotate the roller counter-clockwise (to spread the developer across the magnetic roller ) then print a sample.

If the printer takes a while to “warm up,” then try adding a little more developer. This time, rotating the magnetic roller clockwise. Note: When finished, the magnetic roller will be “bald” in some areas. This is normal.

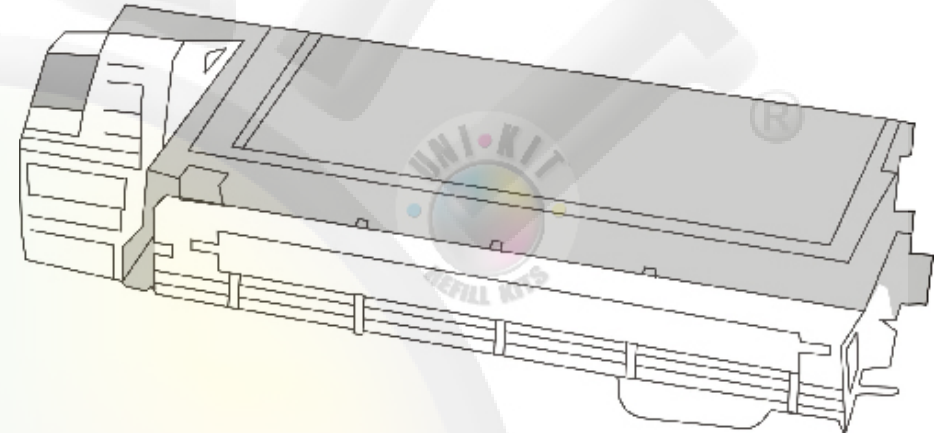

Please be advised that some toner refill kits may be compatible with multiple toner cartridges.



Xerox – 106R482

[CLICK HERE TO GO THE INDEX](#)

#### REQUIRED FOR A SUCCESSFUL REFILL:

- Toner
- 1 funnel cap

#### *General Refilling Procedures:*

Use a screwdriver to remove the small screw holding the waste hopper in place. Turn the cartridge over, press on the clear plastic tab while pressing on the tab gently turn the waste hopper away from the body of the cartridge. Do not be alarmed if the plastic prong cracks or breaks off. Use a screwdriver to remove the two small screws to release the end cap. Lift up on the end cap while pulling it to the left to remove it. You will now see a large plastic plug. Use a flathead screwdriver to pop out the large plastic plug found on the side of the side of the cartridge.

Before opening the bottle of toner, turn it upside down and tap it on a table to loosen the toner and allow it to flow freely. Remove the cap and pull the seal off the bottle. Attach the funnel cap making to sure it is on tightly. Tilt the funnel cap toward the filling hole and insert it into the hole. If the toner stops flowing before the cartridge is full, simply remove the toner, close the cap, turn the bottle upside down and tap it on a table. Once the cartridge is full, seal the hole with the plug by twisting it until it is completely seated.

Perform the following steps over a newspaper:

Slide open the door over the waste hopper and dump out the waste toner onto the newspaper. Reassemble the cartridge. Now gently shake the cartridge side to side to distribute the toner.



#### **DEVELOPER NOTE:**

Adding developer onto your cartridge's magnetic roller is similar to pouring mustard on a hotdog. Applying less developer is better than applying too much developer.

Pour a thin bead of developer across the length of the magnetic roller. Rotate the roller counter-clockwise (to spread the developer across the magnetic roller ) then print a sample.

If the printer takes a while to "warm up," then try adding a little more developer. This time, rotating the magnetic roller clockwise. Note: When finished, the magnetic roller will be "bald" in some areas. This is normal.

Please be advised that some toner refill kits may be compatible with multiple toner cartridges.



Xerox Phaser 3100

[CLICK HERE TO GO THE INDEX](#)

#### REQUIRED FOR A SUCCESSFUL REFILL:

- Toner
- 1 Phillips screwdriver and flat head screw driver
- Needle nose pliers

Note: Please read carefully before refilling cartridge.

#### *General Refilling Procedures:*

Using the screw driver, remove the screws on the side of the cartridge so that the sealing plug can be revealed (Picture A.). You will need to remove some gears to access the toner plug, please remember the place of each gear before removing them from the cartridge. Once you have located the sealing plug, use the flat head screw driver to gently loosen the sealing plug (Picture B.). With the needle nose pliers, gently, but forcefully pull the plug completely off the cartridge. If the plug happens to bent or crack, you may use electrical tape or duct tape to securely seal the cracks or bents once you have replaced the plug at the end of the refill process.

Empty any toner left inside the cartridge (mixing two different brands of toners could result in bad printing, and unpredictable results).

Before opening the bottle of toner, turn it upside down and tap it on a table to loosen the toner and allow it to flow freely. Remove the cap and pull the seal off the bottle. Attach the funnel cap making it sure it is on tightly. Tilt the cartridge at a 45 degree angle and then the funnel cap toward the filling hole and insert it into the hole. If the toner stops flowing before the cartridge is full, simply remove the toner, close the cap, turn the bottle upside down and tap it on a table. Once you are done refilling this cartridge, place the sealing plug back in its place and use duct tape or electrical tape to seal up any necessary cracks on the plug.

Remember to replace the key card before installing the cartridge into the printer. This will insure that the counter is reset and ready for use.





Please be advised that some toner refill kits may be compatible with multiple toner cartridges.



Xerox Phaser 7300

[CLICK HERE TO GO THE INDEX](#)

**REQUIRED FOR A SUCCESSFUL REFILL:**

- Toner
- 1 funnel cap

Note: Please read carefully before refilling cartridge.

**General Refilling Procedures:**

Hopper section is separated into two sections; one side of the hopper is for the toner delivery and contains the toner ready for printing. The other side is for the Waste toner, toner is spread evenly across this section by means of an Archimedes screw. It is essential that all the toner is removed from both of these two sections, before the new toner is placed into the hopper unit. Simply opening the gate at the bottom of the hopper, and pulling out the black bung on the side, gives us the opportunity to thoroughly clean the new toner section of the hopper.

To clean the waste section: On the side of the hopper is a spring loaded gate, which can be pushed back to open the waste section to allow cleaning. Pour all waste toner out and discard it. When you have emptied the waste toner, remember to place the plug back into its place.

Now the cartridge can be refilled. Using illustration D as a reference carefully remove the hopper plug by placing a small flat blade screwdriver behind the lip of the bung, and prise it away from the hopper unit. Care should be taken when refilling the hopper unit, as toner can leak out of the main gate, simply place some tape over the gate area whilst filling to stop leaking.

Before opening the bottle of toner, turn it upside down and tap it on a table to loosen the toner and allow it to flow freely. Remove the cap and pull the seal off the bottle. Attach the funnel cap making to sure it is on tightly. Tilt the cartridge at a 45 degree angle and then the funnel cap toward the filling hole and insert it into the hole. If the toner stops flowing before the cartridge is full, simply remove the toner, close the cap, turn the bottle upside down and tap it on a table. Once you are done refilling this cartridge, replace the plug back into its place and combine the toner unit with the drum unit. Your cartridge is now ready for use.

A. Toner unit (top) Drum unit (bottom)



B. Toner unit



C. Waste hopper section



D. Toner hopper section





Please be advised that some toner refill kits may be compatible with multiple toner cartridges.



XEROX 7400 / XEROX 7450

[CLICK HERE TO GO THE INDEX](#)

### REQUIRED FOR A SUCCESSFUL REFILL:

- Toner
- 1 funnel cap
- 1 flathead screwdriver

### General Refilling Procedures:

Use a flathead screwdriver to pop out the large plastic plug found on the side of the side of the cartridge.

**IMPORTANT:** You must dispose of any original toner in the cartridge as much as possible before refilling. Dispose of toner properly into a trash can.

Before opening the bottle of toner, turn it upside down and tap it on a table to loosen the toner and allow it to flow freely. Remove the cap and pull the seal off the bottle. Attach the funnel cap making to sure it is on tightly. Tilt the funnel cap toward the filling hole and insert it into the hole. If the toner stops flowing before the cartridge is full, simply remove the toner, close the cap, turn the bottle upside down and tap it on a table. Once the cartridge is full, seal the hole with the plug by twisting it until it is completely seated. Now gently shake the cartridge side to side to distribute the toner.

### Replacing the chip

Remove the sticker as shown in illustration B. With the flathead screwdriver, pop open the compartment and remove the OEM chip. Replace with the new Uni-kit compatible chip.

*Note: The Xerox 7450 toner cartridge may look different than the pictures to the right, however, the refilling method is the same. Both the 7400 and 7450 have a removable plug and chip that can be found in a similar compartment.*



A.

B.



C.

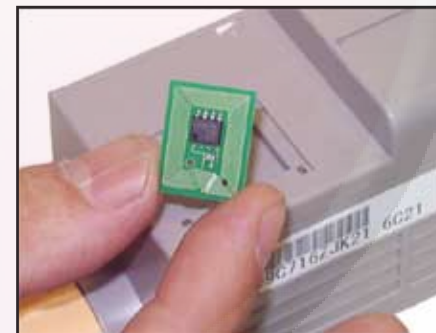

Please be advised that some toner refill kits may be compatible with multiple toner cartridges.



XEROX 7750, 7760

[CLICK HERE TO GO THE INDEX](#)

#### REQUIRED FOR A SUCCESSFUL REFILL:

- Toner (*For Refilling Only*)
- 1 funnel (*For Refilling Only*)
- Xerox 7750 drum (*For Drum Replacement Only*)
- Small Metal Rod (*For Drum Replacement Only*)
- Xerox 7750 drum replacement smartchip (*For Drum Replacement Only*)

**IMPORTANT:** If any toner is inside the cartridge before refilling, please dispose of it properly (example: trash can). For best results, try disposing as much of the OEM toner as possible, or try using as much of it so that it doesn't go to waste.

#### General Refilling Procedures:

Carefully unscrew one of the ends of the toner cartridge.

Before opening the bottle of toner, turn it upside down and tap it on a table to loosen the toner and allow it to flow freely. Remove the cap and pull the seal off the bottle. Attach the funnel cap making sure it is on tightly. Tilt the funnel cap toward the filling hole and begin to pour. If the toner stops flowing before the cartridge is full, simply remove the toner, close the cap, turn the bottle upside down and tap it on a table. Once the cartridge is full, seal the hole by screwing the end of the cartridge back on. Now gently shake the cartridge side to side to distribute the toner.



#### Steps to Drum Replacement:

1. Remove the Xerox 7750 imaging unit from the cartridge
2. In order to access the drum unit (the cylindrical drum), push the rod on the inside of the right end cap until the end cap pops out and is separated. You can only accomplish this by pushing on the end cap from the inside
3. Once the drum pops out, you will notice two gears are on the drum. Unscrew the left and right gears from the drum unit.
4. Discard the old drum, but keep the two gears
5. Screw the old gears onto the new drum. Take care not to scratch the main body of the new drum!
6. Place the new drum into the imaging unit. (Note: do not replace the right end cap until the smartchip is replaced.)
7. Unplug the old drum smartchip from the housing. Replace it with the new smartchip by plugging the chip into the housing. Now you can replace the right end cap
8. Repeat the same procedure on all 4 imaging units.

© All rights reserved, Easy Group, LLC. Version 6.0

All trademarks are property of their respective owners. Uni-Kit® has no association with any of the manufacturers listed here such as Hp, Epson, Lexmark, Xerox, etc. All logos and brand names shown here are used for identification purposes only. It is illegal to reproduce these instructions without written licensing consent from Easy Group LLC.

Please be advised that some toner refill kits may be compatible with multiple toner cartridges.



## XEROX PHASER 3300

[CLICK HERE TO GO THE INDEX](#)

### REQUIRED FOR A SUCCESSFUL REFILL:

- Toner
- 1 Phillips screwdriver and flat head screw driver
- Needle nose pliers

Note: Please read carefully before refilling cartridge.

### General Refilling Procedures:

Remove toner hopper plug and empty any toner left inside the cartridge (mixing two different brands of toners could result in bad printing, or rare discoloration in your prints).

Before opening the bottle of toner, turn it upside down and tap it on a table to loosen the toner and allow it to flow freely. Remove the cap and pull the seal off the bottle. Attach the funnel cap making sure it is on tightly. Tilt the cartridge at a 45 degree angle and then the funnel cap toward the filling hole and insert it into the hole. If the toner stops flowing before the cartridge is full, simply remove the toner, close the cap, turn the bottle upside down and tap it on a table. Once you are done refilling this cartridge, place the sealing plug back in its place and use duct tape or electrical tape to seal up any necessary cracks on the plug.

The cartridge is now ready for use.

1.

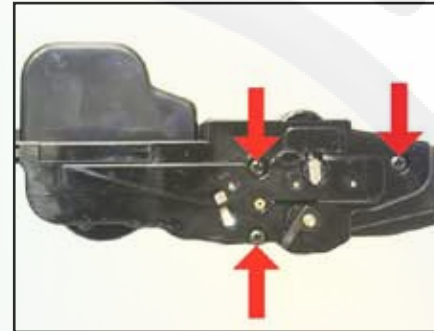

Remove Screws

2.



Remove Side Panel

3.



Remove Plug and Toner

4.

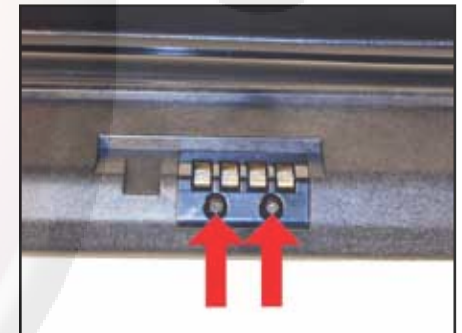

The chip is held in place by plastic rivets. It must be replaced for the cartridge to work. It can be replaced by first cutting the plastic rivets, then drilling two holes and setting two self-tapping screws in place.



Please be advised that some toner refill kits may be compatible with multiple toner cartridges.



Xerox 5500

[CLICK HERE TO GO THE INDEX](#)

#### REQUIRED FOR A SUCCESSFUL REFILL:

- Toner
- 1 funnel cap

#### General Refilling Procedures:

Turn the cartridge so that the color side cap faces you. Once the side cap faces you, remove the side cap by using a small flat head screw driver to press up on the locks that hold the side cap to the cartridge. Remove the side cap so that you see the toner plug underneath it. With the small flat head screwdriver, slowly and carefully remove the plug. (Please remember that this plug will be used again, so do not damage it by tearing it out).

Before opening the bottle of toner, turn it upside down and tap it on a table to loosen the toner and allow it to flow freely. Remove the cap and pull the seal off the bottle. Attach the funnel cap making sure it is on tightly. Tilt the funnel cap toward the filling hole and insert it into the hole. If the toner stops flowing before the cartridge is full, simply remove the toner, close the cap, turn the bottle upside down and tap it on a table. Once the cartridge is full seal the hole with the plug.

Now gently shake the cartridge side to side to distribute the toner.

t



To remove the chip, simply lift the middle cover that holds the chip in place, slide the chip out, and release the cover. Repeat the process for installation of the chip.



Please be advised that some toner refill kits may be compatible with multiple toner cartridges.



Ricoh Aficio SP C220

[CLICK HERE TO GO THE INDEX](#)

#### REQUIRED FOR A SUCCESSFUL REFILL:

- Toner
- 1 funnel cap
- 1 hole plug (*OPTIONAL - Duct Tape can replace hole plug*)
- Toner Hole Making Tool

#### General Refilling Procedures:

Rest the Hole Making Tool on its stand and plug into an outlet. Wait 3 full minutes before using. Position the copper bit on the cartridge in the spot indicated by the photograph and push gently until it melts a hole in the cartridge. Remove the tool, place it back on its stand and unplug it. If the small piece of plastic has fallen into the cartridge, it must be removed, as this can damage your cartridge or cause print defects. If the piece remains in the tool, wait for the tool to cool down and pry it out.

Before opening the bottle of toner, turn it upside down and tap it on a table to loosen the toner and allow it to flow freely. Remove the cap and pull the seal off the bottle. Attach the funnel cap making to sure it is on tightly. Tilt the funnel cap toward the filling hole and insert it into the hole. If the toner stops flowing before the cartridge is full, simply remove the toner, close the cap, turn the bottle upside down and tap it on a table. Once the cartridge is full seal the hole with the plug.

Do not press down on the plug since the cartridge is resting on a table this can actually damage the photo-optic drum. Instead hold one end of the cartridge up off the table and twist the plug until it fully sealed. Now gently shake the cartridge side to side to distribute the toner.

*Please keep in mind that a plug might not be an option for your cartridge. There are mechanisms that may prevent the plug from sealing the hole properly or interfering with other parts inside. In cases like this, duct tape would be a better option to seal the hole.*



Create Refill Hole Here